

Ventura County Technical Guidance Manual for Stormwater Quality Control Measures

Manual Update 2010



Ventura Countywide
Stormwater Quality
Management Program



Prepared by

Larry Walker Associates
707 Fourth Street, Suite 200
Davis, CA 95616

Geosyntec Consultants
475 14th Street
Oakland, CA 94612

Stakeholder Draft September 27, 2010

Manual Updates: The 2010 TGM may be periodically updated to correct minor errors and unintentional omissions. Additionally, due to the evolving nature of stormwater quality management, the 2010 TGM may also be updated to incorporate new and innovative control measures. 2010 TGM users should ensure that they are referencing the most current edition by checking www.vcstormwater.org or contacting the local permitting agency.

TABLE OF CONTENTS

Manual Updates i

1 INTRODUCTION..... 1-1

1.1 Goals 1-1

1.2 Regulatory Background 1-1

1.3 Impacts of Land Development..... 1-3

1.4 Stormwater Management Principles..... 1-4

1.5 Applicability 1-5

 New Development Projects..... 1-5

 Redevelopment Projects 1-6

 Effective Date..... 1-7

1.6 Organization of the 2010 TGM..... 1-9

2 STORMWATER MANAGEMENT STANDARDS2-1

2.1 Introduction 2-1

2.2 Step 1: Determine Project Applicability 2-1

 Step 1a: Determine RPAMP Eligibility..... 2-1

 Step 1b: Single Family Hillside Homes 2-3

 Step 1c: Roadway Projects..... 2-6

2.3 Step 2: Assess Site Conditions..... 2-7

2.4 Step 3: Apply Site Design Principles and Techniques 2-7

2.5 Step 4: Apply Source Control Measures 2-8

2.6 Step 5: Apply BMPs to Reduce EIA to ≤5%..... 2-9

 Step 5a: Calculate Allowable EIA..... 2-11

 Step 5b: Calculate Impervious Area to be Retained 2-12

 Step 5c: Calculate the Volume to be Retained (SQDV) 2-12

 Step 5d: Select and Size Onsite Retention BMPs to Achieve 5% EIA 2-14

 Step 5e: Select and Size Biofiltration BMPs to Reduce EIA to ≤5% 2-14

2.7 Step 6: Alternative Compliance 2-15

2.8 Step 7: Apply Treatment Control Measures 2-24

2.9 Step 8: Continue Project Design Process: Flood Control and
Hydromodification Requirements 2-28

 Step 8a: Flood Control Requirements 2-28

 Step 8b: Hydromodification (Flow/Volume/Duration) Control Criteria..... 2-28

2.10 Step 9: Develop Maintenance Plan 2-30

3 SITE ASSESSMENT AND BMP SELECTION 3-30

3.1 Assessing Site Conditions and Other Constraints..... 3-30

 Site Conditions 3-30

3.2	Technical Feasibility Screening.....	3-36
	Determining Maximum Volume Feasibly Retained and Biofiltered.....	3-37
3.3	Identification of Pollutants of Concern	3-41
	Land Use Types/Sources.....	3-42
	Receiving Water Impairments and TMDLs	3-43
	Uncertainty Associated with Identification of Pollutants of Concern.....	3-43
3.4	Treatment Control Measure Selection Guidance.....	3-43
	Treatment Control Measure Selection Criteria	3-43
	Consideration of Site-Specific Conditions.....	3-44
4	SITE DESIGN PRINCIPLES AND TECHNIQUES	4-1
4.1	Introduction.....	4-1
4.2	Site Planning.....	4-2
	Purpose	4-2
	Design Criteria.....	4-2
4.3	Protect and Restore Natural Areas	4-4
	Purpose	4-4
	Design Criteria.....	4-4
4.4	Minimize Land Disturbance	4-6
	Purpose	4-6
	Design Criteria.....	4-6
4.5	Minimize Impervious Cover	4-7
	Purpose	4-7
	Design Criteria.....	4-7
4.6	Apply LID at Various Scales	4-9
	Purpose	4-9
	Design Criteria.....	4-9
4.7	Implement Integrated Water Resource Management Practices	4-11
	Purpose	4-11
	Design Criteria.....	4-11
5	SOURCE CONTROL MEASURES	5-1
5.1	Introduction.....	5-1
5.2	Description.....	5-1
5.3	Site-Specific Source Control Measures.....	5-3
	S-1: Storm Drain Message and Signage	5-3
	S-2: Outdoor Material Storage Area Design	5-6
	S-3: Outdoor Trash Storage Area Design.....	5-7
	S-4: Outdoor Loading/Unloading Dock Area Design	5-8
	S-5: Outdoor Repair/Maintenance Bay Design	5-10
	S-6: Outdoor Vehicle/Equipment/Accessory Washing Area Design.....	5-11

S-7: Fueling Area Design 5-12

S-8: Proof of Control Measure Maintenance 5-13

6 STORMWATER BMP DESIGN 6-1

6.1 Introduction 6-1

6.2 General Considerations 6-1

Maintenance Responsibility 6-2

Pretreatment 6-2

Infiltration 6-3

Biofiltration BMPs 6-4

Treatment Control Measures 6-5

“On-line” and “Off-line” Facilities 6-5

6.3 Retention BMP, Biofiltration BMP, and Treatment Control Measure Fact
Sheets 6-6

INF-1: Infiltration Basin 6-8

INF-2: Infiltration Trench 6-25

INF-3: Bioretention 6-34

INF-4: Drywell 6-50

INF-5: Permeable Pavement 6-58

INF-6: Proprietary Infiltration 6-73

RWH-1: Cistern 6-79

ET-1: Green Roof 6-83

ET-2: Hydrologic Source Control BMPs 6-89

BIO-1: Bioretention with Underdrain 6-96

BIO-2: Planter Box 6-109

BIO-3: Vegetated Swale 6-120

BIO-4: Vegetated Filter Strip 6-135

BIO-5: Proprietary Biotreatment 6-144

TCM-1: Dry Extended Detention Basin 6-147

TCM-2: Wet Detention Basin 6-168

TCM-3: Constructed Wetland 6-188

TCM-4: Sand Filters 6-205

TCM-5: Cartridge Media Filter 6-218

PT-1: Hydrodynamic Separation Device 6-222

PT-2: Catch Basin Insert 6-226

7 MAINTENANCE PLAN 7-1

7.1 Site Map 7-1

7.2 Baseline Descriptions 7-1

7.3 Spill Plan 7-2

7.4 Facility Changes 7-2

7.5 Training 7-3

7.6 Basic Inspection and Maintenance Activities 7-3
 7.7 Revisions of Pollution Mitigation Measures..... 7-3
 7.8 Monitoring & Reporting Program 7-4

List of Tables

Table 2-1: Allowed Design Storm Methodology Based on Project Size 2-26
 Table 3-1: Recommended Criteria for Percent of Site Feasible to Dedicate to BMPs..... 3-39
 Table 3-2: Common Post-Development Sources of Stormwater Pollutants 3-42
 Table 3-3: BMP Site Suitability Considerations..... 3-46
 Table 3-4: BMP Cost Considerations 3-48
 Table 4-1: Rule of Thumb Space Requirements for BMPs..... 4-3
 Table 5-1: Summary of Site-Specific Source Control Measure Design Features 5-2
 Table 5-2: Design Criteria for Outdoor Material Storage Area Design 5-7
 Table 5-3: Design Criteria for Outdoor Trash Storage Areas 5-8
 Table 5-4: Design Criteria for Outdoor Loading/ Unloading Areas 5-9
 Table 6-1: Infiltration Basin Design Criteria..... 6-11
 Table 6-2: Suitability Assessment Related Considerations for Infiltration Facility Safety Factors 6-15
 Table 6-3: Design Related Considerations for Infiltration Facility Safety Factors 6-17
 Table 6-4: Infiltration Facility Safety Factor Determination Worksheet..... 6-18
 Table 6-5: Infiltration Trench Design Criteria..... 6-28
 Table 6-6: Bioretention Design Criteria 6-37
 Table 6-7: Suitability Assessment Related Considerations for Infiltration Facility Safety Factors 6-39
 Table 6-8: Design Related Considerations for Infiltration Facility Safety Factors 6-40
 Table 6-9: Infiltration Facility Safety Factor Determination Worksheet..... 6-42
 Table 6-10: Infiltration BMP Design Criteria 6-53
 Table 6-11: Permeable Pavements Design Criteria 6-61
 Table 6-12: Suitability Assessment Related Considerations for Infiltration Facility Safety Factors 6-64
 Table 6-13: Design Related Considerations for Infiltration Facility Safety Factors 6-66
 Table 6-14: Infiltration Facility Safety Factor Determination Worksheet..... 6-67
 Table 6-15: Proprietary Infiltration Manufacturer Websites..... 6-76
 Table 6-16: Green Roof Design Criteria 6-85
 Table 6-17: Bioretention Design Criteria 6-98
 Table 6-18: Planter Box Design Criteria 6-111
 Table 6-19: Vegetated Swale Filter Design Criteria 6-122
 Table 6-20: Vegetated Filter Strip Design Criteria..... 6-138
 Table 6-21: Proprietary Biotreatment Device Manufacturer Websites 6-146
 Table 6-22: Sand Filter Design Criteria 6-152
 Table 6-23: Wet Detention Basin Design Criteria..... 6-172

Table 6-24: Constructed Wetland Design Criteria 6-190
Table 6-25: Sand Filter Design Criteria 6-207
Table 6-26: Proprietary Cartridge Media Filter Manufacturer Websites 6-220
Table 6-27: Proprietary Hydrodynamic Device Manufacturer Websites 6-224
Table 6-28: Proprietary Catch Basin Insert Manufacturer Websites..... 6-228

LIST OF FIGURES

Figure 2-1: Stormwater Management Control Measures Design Decision Flowchart..... 2-2

Figure 2-2: Apply BMPs to Reduce EIA to $\leq 5\%$ Process Flow Chart 2-10

Figure 2-3: Alternative Stormwater Management Control Measures Compliance Decision Flow Chart..... 2-18

Figure 2-4: Apply Retention BMPs, Biofiltration or Treatment Control to Treat Remaining SQDV or SQDF 2-25

Figure 5-1: Storm Drain Message Location 5-5

Figure 6-1: Differences between On-line, Off-line, and In-stream Control Measures 6-6

Figure 6-2: Infiltration Basin Design Schematic 6-9

Figure 6-3: Infiltration Trench Design Schematic..... 6-26

Figure 6-4: Bioretention Design Schematic 6-35

Figure 6-5: Drywell Design Schematic 6-51

Figure 6-6: Permeable Pavement Design Schematic 6-59

Figure 6-7: Proprietary Infiltration BMP Design Schematic 6-74

Figure 6-8: Green Roofs 6-84

Figure 6-9: Bioretention with Underdrain Design Schematic 6-97

Figure 6-10: Planter Box Design Schematic 6-110

Figure 6-11: Vegetated Swale Design Schematic 6-121

Figure 6-12: Vegetated Filter Strip Design Schematic..... 6-136

Figure 6-13: Biotreatment Device Design Schematic 6-145

Figure 6-14: Dry Extended Detention Basin Schematic 6-148

Figure 6-15: Perforated Riser Outlet..... 6-149

Figure 6-16: Multiple Orifice Outlet..... 6-150

Figure 6-17: Spillway 6-151

Figure 6-18: Wet Detention Basin Schematic 6-169

Figure 6-19: Riser Outlet..... 6-170

Figure 6-20: Inverted Pipe Outlet 6-171

Figure 6-21: Constructed Wetland Schematic 6-189

Figure 6-22: Sand Filter Design Schematic 6-206

Figure 6-23: Cartridge Media Filter Design Schematic..... 6-219

Figure 6-24: Hydrodynamic Separation Device Design Schematic 6-223

Figure 6-25: Catch Basin Insert Design Schematic 6-227

APPENDICES

Appendix A Glossary of Terms

Appendix B Maps: Watersheds Delineation, Existing Urban Areas, and Environmentally Sensitive Areas

Appendix C Site Soil Type and Infiltration Testing

Appendix D BMP Selection and Combined LID/Treatment BMP Sizing Guidance

Appendix E BMP Sizing Worksheets

Appendix F Flow Splitter Design

Appendix G Design Criteria Checklists for Stormwater Runoff BMPs

Appendix H Stormwater Control Measure Access and Maintenance Agreements

Appendix I Stormwater Control Measure Maintenance Plan Guidelines and Checklists

1 INTRODUCTION

This *Technical Guidance Manual for Stormwater Quality Measures* (2010 TGM) provides guidance for the implementation of stormwater management control measures in new development and redevelopment projects in the County of Ventura and the incorporated cities therein. These guidelines are intended to improve water quality and mitigate potential water quality impacts. These guidelines have been developed to meet the Planning and Land Development requirements contained in Part 4, Section E of the Los Angeles Regional Water Quality Control Board's (Regional Board) municipal separate storm sewer system (MS4) permit ([Order R4-2010-0108](#)) for new development and redevelopment projects.

The Planning and Land Development requirements are not implemented at the discretion of the local permitting agency; they are requirements in Order R4-2010-0108 that must be complied with. The 2010 TGM does not attempt to expand or circumvent these requirements, but rather it provides guidance on how to meet them.

1.1 Goals

The 2010 TGM has been prepared by the Ventura Countywide Stormwater Quality Management Program to accomplish the following goals:

- Ensure that new development and redevelopment projects reduce urban runoff pollution to the "maximum extent practicable" (MEP);
- Ensure that the implementation of measures in the 2010 TGM are consistent with Regional Water Quality Control Board [Order R4-2010-0108](#) and other state requirements;
- Provide guidance to developers, design engineers, agency engineers, and planners on the selection and implementation of appropriate stormwater management control measures; and
- Provide maintenance procedures to ensure that the selected stormwater management control measures will be properly maintained to provide effective, long-term pollution control.

1.2 Regulatory Background

In 1972, the Federal Water Pollution Control Act [later referred to as the Clean Water Act (CWA)] was amended to require National Pollutant Discharge Elimination System (NPDES) permits for the discharge of pollutants to waters of the United States from any point source. In 1987, the CWA was amended to require the United States Environmental Protection Agency (USEPA) to establish regulations permitting

municipal and industrial stormwater discharges under the NPDES permit program. The USEPA published final regulations regarding stormwater discharges on November 16, 1990. The regulations require that MS4 discharges to surface waters be regulated by a NPDES permit.

The Ventura County Watershed Protection District, County of Ventura, and the cities of Camarillo, Fillmore, Moorpark, Ojai, Oxnard, Port Hueneme, San Buenaventura, Santa Paula, Simi Valley, and Thousand Oaks have joined together to form the Ventura Countywide Stormwater Quality Management Program (Program) and are named as co-permittees under a revised countywide municipal NPDES permit for stormwater discharges issued by the Regional Water Quality Control Board in 2010 ([Order R4-2010-0108](#)).

Prior to the issuance of [Order R4-2010-0108](#), stormwater discharges from the Ventura County MS4 were covered under the countywide waste discharge requirements contained in three previous MS4 NPDES Permits (Order 09-0057, Order 00-108, and Order No. 94-082).

Under [Order R4-2010-0108](#), the co-permittees are required to administer, implement, and enforce a Stormwater Quality Management Program (Program) to reduce pollutants in urban runoff to the MEP. The Program emphasizes all aspects of pollution control including, but not limited to, public awareness and participation, source control, regulatory restrictions, water quality monitoring, and treatment control.

For the Program to be successful, it is critical to control urban runoff pollution from new development and redevelopment projects during and after construction. Therefore, the co-permittees implemented the Planning and Land Development Program, one element within the Program, to specifically control post-construction urban runoff pollutants from new development and redevelopment projects. The goals of the Planning and Land Development Program is to minimize runoff pollution typically caused by land development and protect the beneficial uses of receiving waters by employing a sensible combination of Site Design Principles and Techniques, Source Control Measures, Retention Best Management Practices (BMPs), Biofiltration BMPs, and Treatment Control Measures to the level required in [Order R4-2010-0108](#).

“Site Design Principles and Techniques,” “Source Control Measures,” “Retention BMPs,” “Biofiltration BMPs,” and “Treatment Control Measures,” as used in the 2010 TGM refer to BMPs and features incorporated into the design of a new development or redevelopment project, which prevent and/or reduce pollutants in stormwater runoff from the project. These measures are described below:

- 1) ***Site Design Principles and Techniques*** are a stormwater management strategy that emphasizes conservation and use of existing site features to reduce the amount of runoff and pollutant loading that is generated from a project site.

- 2) **Source Control Measures** limit the exposure of materials and activities so that potential sources of pollutants are prevented from making contact with stormwater runoff.
- 3) **Retention BMPs** are stormwater BMPs that are designed to retain water onsite, and achieve a greater reduction in surface runoff from a project site than traditional stormwater Treatment Control Measures.
- 4) **Biofiltration BMPs** are vegetated stormwater BMPs that remove pollutants by filtering stormwater through vegetation and soils.
- 5) **Treatment Control Measures** are engineered BMPs that provide a reduction of pollutant loads and concentrations in stormwater runoff.

The 2010 TGM contains guidance for the design and implementation of all of these types of stormwater management control measures for new development and redevelopment projects.

In addition to the requirements of [Order R4-2010-0108](#), owners and developers of some of the sites in the County may also be subject to the State of California's general permit for stormwater discharge from industrial activities ([Industrial General Permit](#)) and general permit for stormwater discharge from construction activities ([Construction General Permit](#)). The stormwater management control measures provided in the 2010 TGM may also assist the owner or developer in meeting the requirements of the State's construction and industrial permits. The stormwater management staffs of the governing co-permittee agencies are available to provide assistance regarding all of the State stormwater permit requirements.

1.3 Impacts of Land Development

The Cities and County of Ventura have separate stormwater and sanitary sewer conveyance systems. Land development typically creates an increase in impervious surfaces, which increases the amount of runoff and pollutants entering stormwater conveyance systems. Everything that enters the stormwater conveyance system is transported directly to receiving waters (i.e. local channels, rivers, and the ocean), and is not treated in a wastewater treatment plant. Pollutants in untreated stormwater runoff from impervious surfaces that drains to streets and enters storm drains directly contribute to water pollution.

Typically, as stormwater runs over impervious surfaces (e.g., rooftops, roadways, and parking lots), it:

- Does not infiltrate or evapotranspire, which increases runoff volumes, velocities, and flow rates;
- Moves more quickly, which increases runoff velocities; and

- Entrain (i.e., accumulates) pollution and sediment, which increases nutrients, bacteria, and other pollutant concentrations in receiving waters (i.e., local channels, rivers, and the ocean).


The impacts of these alterations due to development may include:

- Increased concentrations of nutrients, toxic pollutants, and bacteria in surface receiving waters, including adjacent land and habitat (e.g., beaches) creeks, estuaries, and storm drain outlets.
- Increased flooding due to higher peak flow rates and runoff volumes produced by a storm.
- Decreased wet season groundwater recharge due to a decreased infiltration area.
- Increased dry season groundwater recharge due to outdoor irrigation with potable or reclaimed water.
- Introduction of baseflows in ephemeral streams due to surface discharge of dry weather urban runoff.
- Increased stream and channel bank instability and erosion due to increased runoff volumes, flow durations, and higher stream velocities (“hydromodification impacts”); and
- Increased stream temperature due to loss of riparian vegetation as well as runoff warmed by impervious surfaces, which decreases dissolved oxygen levels and makes streams inhospitable to some aquatic life requiring cooler temperatures for survival.

1.4 Stormwater Management Principles

Stormwater management principles such as Integrated Water Resource Management (IWRM) and Low Impact Development (LID) can be used to help mitigate the impacts of development. These principles are described below.

The emergence of LID falls under the umbrella of the over-arching concept of IWRM. IWRM is a process which promotes the coordinated development and management of water, land, and related resources. IWRM links traditional development topics such as water supply, wastewater treatment/reclamation, flood control/drainage, water quality, and hydromodification management into a cohesive hydrologic system that recognizes their interdependencies and minimizes their potentially negative effects on the environment. An example of IWRM includes recharging groundwater with reclaimed wastewater to support the water supply. Another example is combining stormwater treatment, hydromodification control, and flood control in a single regional infiltration basin that recharges groundwater, incorporates

recreation, and provides habitat. 

Generally, the 2010 TGM advises to first design for the largest hydrologic controls (such as matching post development 100-year flows with pre-project 100-year flows for flood mitigation requirements), according to the appropriate City or County drainage requirements (not included in the 2010 TGM). Secondly, the 2010 TGM advises to check if flood mitigation will reduce or satisfy the stormwater management requirements (as set forth in the 2010 TGM). If it does not, then add more controls as necessary. Flood mitigation may provide the necessary sediment and pollution control, thereby reducing maintenance requirements for the stormwater management BMPs. A sequence of hydrologic controls should be considered, such as site design, flood drainage mitigation, Retention BMPs, Biofiltration BMPs, and Treatment Control Measures. Each of these controls will have an influence on stormwater runoff from the new development or redevelopment project.

Similar to Source Control Measures, which prevent pollutant sources from contacting stormwater runoff, Retention BMPs and Biofiltration BMPs use techniques to infiltrate, store, use, evaporate, and detain runoff onsite to mimic pre-development hydrology, to the extent feasible. The goal of LID is to increase groundwater recharge, enhance water quality, and prevent degradation of downstream natural drainage channels. This goal may be accomplished with creative site planning and with incorporation of localized, naturally functioning BMPs into the project. Implementation of Retention BMPs and Biofiltration BMPs will reduce the size of additional Treatment Control Measures and Hydromodification Control Measures that may be required for a new development or redevelopment project, and, in many circumstances, may be used to satisfy all stormwater management requirements.

1.5 Applicability

The following projects and associated triggers, contained in subpart 4.E.II of [Order R4-2010-0108](#), are subject to the requirements and standards laid out in the 2010 TGM.

Note that some of the project triggers are based on *total altered surface area* and others on *impervious surface area*, which is an intentional requirement in the MS4 Permit.

New Development Projects

Development projects subject to conditioning and approval for the design and implementation of post-construction stormwater management control measures, prior to completion of the project(s), are:

- 1) All development projects equal to 1 acre or greater of disturbed area that adds more than 10,000 square feet of impervious surface area.
- 2) Industrial parks with 10,000 square feet or more of total altered surface area.

- 3) Commercial strip malls with 10,000 square feet or more of impervious surface area.
- 4) Retail gasoline outlets with 5,000 square feet or more of total altered surface area.
- 5) Restaurants (Standard Industrial Classification (SIC) of 5812) with 5,000 square feet or more of total altered surface area.
- 6) Parking lots with 5,000 square feet or more of impervious surface area, or with 25 or more parking spaces.
- 7) Streets, roads, highways, and freeway construction of 10,000 square feet or more of impervious surface area (see [Section 2](#) for specific requirements).
- 8) Automotive service facilities (Standard Industrial Classification (SIC) of 5013, 5014, 5511, 5541, 7532-7534 and 7536-7539) of 5,000 square feet or more of total altered surface area.
- 9) Projects located in or directly adjacent to, or discharging directly to an Environmentally Sensitive Area (ESA), where the development will:
 - a. Discharge stormwater runoff that is likely to impact a sensitive biological species or habitat; and
 - b. Create 2,500 square feet or more of impervious surface area.
- 10) Single-family hillside homes (see [Section 2](#) for specific requirements).

Redevelopment Projects

Redevelopment projects subject to conditioning and approval for the design and implementation of post-construction stormwater management control measures, prior to completion of the project(s), are redevelopment projects in categories 1 through 10 above that meet the threshold identified below:

- Land-disturbing activity that results in the creation or addition or replacement of 5,000 square feet or more of impervious surface area on an already developed site.

Additionally:

- 1) Projects where redevelopment results in an alteration to more than fifty percent of impervious surfaces of a previously existing development, and the existing development was not subject to the post development stormwater quality control requirements of Board Order 00-108, must mitigate the entire redevelopment project area.

- 2) Projects where redevelopment results in an alteration to more than fifty percent of impervious surfaces of a previously existing development, and the existing development was subject to the post development stormwater quality control requirements of Board Order 00-108, must mitigate only the altered portion of the redevelopment project area and not the entire project area.
- 3) Projects where redevelopment results in an alteration of less than fifty percent of impervious surfaces of a previously existing development must mitigate only the altered portion of the redevelopment project area and not the entire project area.

Land-disturbing activity that results in the creation or addition or replacement of less than 5,000 square feet of impervious surface area on an already developed site, or that results in a decrease in impervious area which was subject to the post-development stormwater quality control requirements of Board Order 00-108, is not subject to mitigation unless so directed by the local permitting agency.

Redevelopment does not include routine maintenance activities that are conducted to maintain the original line and grade, hydraulic capacity, or original purpose of the facility or emergency redevelopment activity required to protect public health and safety. Impervious surface replacement, such as the reconstruction of parking lots and roadways, that does not disturb additional area and maintains the original grade and alignment, is considered a routine maintenance activity. Agencies' flood control, drainage, and wet utilities projects that maintain original line and grade or hydraulic capacity are considered routine maintenance. Redevelopment also does not include the repaving of existing roads to maintain original line and grade.

Existing single-family dwelling and accessory structure projects are exempt from the redevelopment requirements unless the project creates, adds, or replaces 10,000 square feet of impervious surface area.

Effective Date

The new development and redevelopment requirements contained in Part 4, Section E of Board [Order R4-2010-0108](#) (the "Order") shall become effective 90 calendar days after the Regional Water Quality Control Board Executive Officer approves the 2010 TGM (the "Effective Date"). After the Effective Date, all applicable projects, except those identified below, must comply with the new development and redevelopment requirements contained in Part 4, Section E of the Order.

The new development and redevelopment requirements contained in Part 4, Section E of the Order shall not apply to the projects described in paragraphs 1 through 5 below. Projects meeting the criteria listed in paragraphs 1 through 5 below shall instead continue to comply with the performance criteria set forth in the 2002 Technical Guidance Manual for Stormwater Quality Control Measures under Board Order 00-108:

- 1) Projects or phases of projects where the project's applications have been "deemed complete for processing" (or words of equivalent meaning), by the applicable local permitting agency in accordance with the local permitting agency's applicable rules prior to the Effective Date; or
- 2) Projects that are the subject of an approved Development Agreement and/or an adopted Specific Plan; or an application for a Development Agreement and/or Specific Plan where the application for the Development Agreement and/or Specific Plan has been "deemed complete for processing" (or words of equivalent meaning), by the applicable local permitting agency in accordance with the local permitting agency's applicable rules, and thereafter during the term of such Development Agreement and/or Specific Plan unless earlier cancelled or terminated; or
- 3) All private projects in which, prior to the Effective Date, the private party has completed public improvements; commenced design, obtained financing, and/or participated in the financing of the public improvements; or which requires the private party to reimburse the local agency for public improvements upon the development of such private project; or
- 4) Local agency projects for which the governing body or their designee has approved initiation of the project design prior to the Effective Date; or
- 5) A Tentative Map or Vesting Tentative Map deemed complete or approved by the local permitting agency prior to the Effective Date, and subsequently a Revised Map is submitted, the project would be exempt from the 2010 TGM provisions if the change requested under the Revised Map was solely initiated by the local permitting agency or other public agency, and the local permitting agency has determined that the revisions substantially conform to original map design, consistent with Subdivision Map Act requirements. Changes must also comply with local and state law.

The intent of these guidelines is to ensure that projects for which the applications have been deemed "complete" or the applicants have worked with local permitting agency staff to develop a final, or substantially final, drainage concept and site layout that includes water quality treatment based upon the performance criteria set forth in the 2002 Technical Guidance Manual for Stormwater Quality Control Measures prior to the Effective Date, are not required to redesign their proposed projects for purposes of complying with the new development and redevelopment requirements contained in Part 4, Section E of Board [Order R4-2010-0108](#).

In addition, any project, phase of a project, or individual lot within a larger previously-approved project, where the application for such project has been "deemed complete for processing" (or words of equivalent meaning) that does not have a final or substantially final drainage concept as determined by the local permitting agency or a site layout that includes water quality treatment must comply with the performance standards set forth in the 2010 TGM.

1.6 Organization of the 2010 TGM

The 2010 TGM is divided into seven sections and nine appendices:

- [Section 1](#) Introduction
- [Section 2](#) Stormwater Management Standards
- [Section 3](#) Site Assessment and BMP Selection
- [Section 4](#) Site Design Principles & Techniques
- [Section 5](#) Source Control Measures
- [Section 6](#) Retention BMPs, Biofiltration BMPs, and Treatment Control Measure Design
- [Section 7](#) Operation and Maintenance Planning

- Appendix A Glossary of Terms
- Appendix B Maps: Watersheds Delineation, Existing Urban Areas, Environmentally Sensitive Areas, and 85th Percentile Rainfall Depth
- Appendix C Site Soil Type and Infiltration Testing
- Appendix D BMP Selection Guidance
- Appendix E BMP Sizing Worksheets
- Appendix F Flow Splitter Design
- Appendix G Design Criteria Checklists for Stormwater Runoff BMPs
- Appendix H Stormwater Control Measure Access and Maintenance Agreements
- Appendix I Stormwater Control Measure Maintenance Plan Guidelines and Checklists

2 STORMWATER MANAGEMENT STANDARDS

2.1 Introduction

This section outlines the design process to comply with stormwater control requirements. A flowchart is presented in Figure 2-1 to illustrate a step-by-step process for incorporating these stormwater management control measures.

The selection of appropriate stormwater management control measures should be a collaborative effort between the project proponent and the local permitting agency staff. It is recommended that discussions between project planners, engineers, and local permitting agency staff regarding selection of stormwater management control measures occur very early in the design process.

2.2 Step 1: Determine Project Applicability

New development and redevelopment projects meeting the applicability criteria contained in Section 4.E.II of [Order R4-2010-0108](#) [presented in [Section 1.5](#) of the 2010 TGM] must include control measures specified in the 2010 TGM. These projects should be designed to meet the performance criteria described in the steps below.

Separate requirements exist for three types of projects:

- Projects located within a Redevelopment Project Area Master Plan (RPAMP);
- Single Family Hillside Homes; and
- Roadway Projects.

The requirements for these three project types are described in further detail in the substeps below. Projects that are not applicable are still subject to stormwater agency review, especially for flood drainage requirements. Stormwater management control measures may be required by the governing agency for inapplicable projects, depending on the potential discharge of pollutants in stormwater runoff, impairments in receiving water, or other special conditions that would require increased protection.

Step 1a: Determine RPAMP Eligibility

If a project is located within the boundary of a Redevelopment Project Area Master Plan (RPAMP), the stormwater management requirements in the RPAMP take precedence over the control measures and performance criteria specified in this 2010 TGM. A stormwater agency may apply to the Regional Water Quality Control Board for approval of a RPAMP in consideration of exceptional site constraints that inhibit site-by-site or project-by-project implementation of post-construction requirements.

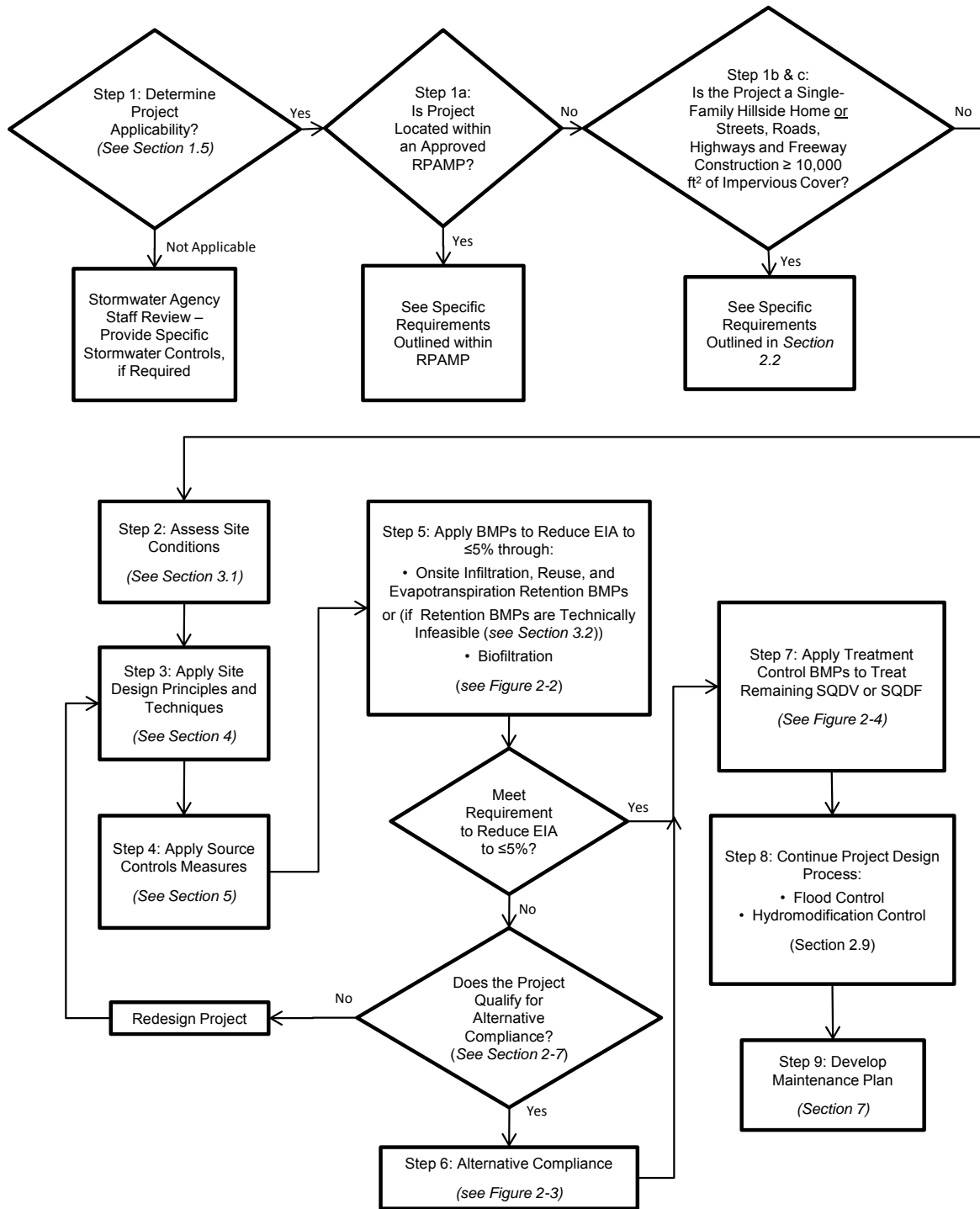


Figure 2-1: Stormwater Management Control Measures Design Decision Flowchart

Step 1b: Single Family Hillside Homes

Single-family hillside home projects have specific requirements separate from other new development and redevelopment project categories. According to [Order R4-2010-0108](#), a hillside is defined as:

“Property located in an area with known erosive soil conditions, where the development will result in grading on any slope that is 20% or greater or an area designated by the Municipality under a General Plan or ordinance as a ‘hillside area.’”

The measures presented in this substep comprise the performance standard for single-family hillside home new development and redevelopment projects (additional information on these measures may be found in [Section 4](#) and [Section 5](#)).

Conserve Natural Areas

Each project site possesses unique topographic, hydrologic and vegetative features, some of which are more suitable for development than others. Locating development on the least sensitive portion of a site and conserving naturally vegetated areas can minimize environmental impacts in general and stormwater runoff impacts in particular.

The following measures are required and should be included in the project site layout, consistent with applicable General Plan and Local Area Plan policies and if appropriate and feasible with the given site conditions:

- 1) Concentrate or cluster improvements on the least-sensitive portions of the site and leave the remaining land in a natural undisturbed state;
- 2) Limit clearing and grading of native vegetation at the site to the minimum area needed to build the home, allow access, and provide fire protection;
- 3) Maximize trees and other vegetation at the site by planting additional vegetation, clustering tree areas, and promoting the use of native and/or drought-tolerant plants; and
- 4) Preserve riparian areas and wetlands.

Protect Slopes and Channels

Erosion of slopes and channels can be a major source of sediment and associated pollutants such as nutrients, if not properly protected and stabilized.

Slope Protection

Slope protection practices must conform to local permitting agency erosion and sediment control standards and design requirements. The post-construction design

criteria described below are intended to enhance and be consistent with these local standards.

- 1) Slopes must be protected from erosion by safely conveying runoff from the tops of slopes.
- 2) Slopes must be vegetated by first considering the use of native or drought-tolerant species.

Channel Protection

The following measures should be implemented to provide erosion protection to unlined receiving streams on the project site. Activities and structures must conform to applicable permitting requirements, standards, and specifications of agencies with jurisdiction (i.e., U.S. Army Corps of Engineers, California Department of Fish and Game, or Regional Water Quality Control Board).

- 1) Use natural drainage systems to the maximum extent practicable, but minimize runoff discharge to the maximum extent practicable.
- 2) Stabilize permanent channel crossings.
- 3) Install energy dissipaters, such as rock riprap, at the outlets of storm drains, culverts, conduits or channels that discharge into unlined channels.

Provide Storm Drain System Stenciling and Signage

Storm drain message markers or placards are required at all storm drain inlets within the project boundary. The signs should be placed in clear sight facing anyone approaching the inlet from either side. All storm drain inlet locations must be identified on the development site map.

Some local agencies within the County have approved storm drain message placards for use. Consult local permitting agency stormwater staff to determine specific requirements for placard types and installation methods.

Divert Roof Runoff and Surface Flows to Vegetated Area(s) or Collection System(s), Unless the Diversion Would Result in Slope Instability



Diverted Roof Runoff
City of Santa Barbara

Disconnecting downspouts divert water from roof gutters to (1) vegetated pervious areas of the site in order to allow for infiltration, storage, evapotranspiration (i.e., evaporation and uptake of water by plants), and treatment, or (2) a rainwater collection system (e.g., a rain barrel or a cistern). Disconnected downspouts differ from conventional downspout systems that provide a direct connection of roof runoff to stormwater conveyance systems (storm drains), which quickly collect and convey stormwater away from the site. “Flow spreading” is a technique used to spread runoff from rooftops, sidewalks, patios, and driveways out over a vegetated pervious area, rather than concentrating and conveying the runoff directly to a stormwater conveyance system.

Dispersion methods include splash blocks, gravel-filled trenches, or other methods which serve to spread runoff over vegetated pervious areas. Sheet flow dispersion is the simplest method and can be used for any impervious or pervious surface that is graded so as to avoid concentrating flows. Because flows are already dispersed as they leave the surface, they only need to traverse through a narrow band of adjacent vegetation for the runoff to be effectively attenuated and treated.

The following requirements apply to runoff diversion:

- Vegetated flowpaths for the diverted flows should be at least 25 feet in length, measured from the diversion location to the downstream property line, structure, steep slope, stream, wetland, or impervious surface. The vegetated flowpath must be covered with well-established lawn or pasture, landscaping with well-established groundcover, or native vegetation with natural groundcover. The groundcover should be dense enough to help disperse and infiltrate flows and to prevent erosion.
- If the vegetated flowpath (measured as defined above) is less than 25 feet, a perforated stub-out connection may be used in lieu of downspout dispersion. A perforated stub-out may also be used where implementation of downspout dispersion might cause erosion or flooding problems, either onsite or on adjacent lots. This provision might be appropriate, for example, for lots constructed on steep hills where downspout discharge could be cumulative and might pose a potential hazard for lower lying lots. It could also be

appropriate where dispersed flows could create problems for adjacent offsite lots. The use of a perforated stub-out in lieu of downspout dispersion may be determined by the Local permitting agency.

- In general, if the ground is sloped away from the foundation and there is adequate vegetation and area for effective dispersion, splash blocks will adequately disperse stormwater runoff. If the ground is fairly level, if the structure includes a basement, or if foundation drains are proposed, splash blocks with downspout extensions may be a better choice because the discharge point is moved away from the foundation. Downspout extensions may include piping to a splash block/discharge point a considerable distance from the downspout, as long as the runoff can travel through a well-vegetated area as described above.
- No erosion or flooding of downstream properties may result.
- Runoff discharged towards steep slopes or landslide hazard areas must be evaluated by a geotechnical engineer or qualified geologist. The discharge point may not be placed on or above slopes greater than 20% or above erosion hazard areas without evaluation by a geotechnical engineer or qualified geologist and jurisdiction approval.
- For sites with septic systems, the discharge point must be down gradient of the drainfield primary and reserve areas. This requirement can be waived by the jurisdiction's permit review staff if site topography clearly prohibits flows from intersecting with the drainfield.

Step 1c: Roadway Projects

Roadway projects have specific requirements separate from other new development and redevelopment project categories. The measures presented in this substep comprise the performance standard for street, roadway, highway, and freeway projects. Section 4.E.II of [Order R4-2010-0108](#) requires street, roadway, highway, and freeway projects that construct 10,000 square feet or more of impervious surface area, to incorporate USEPA guidance regarding [Managing Wet Weather with Green Infrastructure: Green Streets](#) to the maximum extent practicable.

The following requirements apply to the impervious area within the right-of-way associated with streets, roads, highways, and freeways projects and the right-of-way areas that are part of a larger project. These requirements do not apply to routine maintenance activities that are conducted to maintain original line and grade, hydraulic capacity, original purpose of facility, or emergency redevelopment activity required to protect public health and safety. Impervious surface replacement, such as the reconstruction of parking lots and roadways, which does not disturb additional area and maintains the original grade and alignment, is considered a routine maintenance activity. Agencies' flood control, drainage, and wet utilities projects that

maintain original line and grade or hydraulic capacity are considered routine maintenance. Also, the requirements do not apply to the repaving of existing roads to maintain original line and grade.

Minimum requirements for the area within the right-of-way associated with streets, roads, highways, and freeways are as follows:

- 1) Provide Retention BMPs or Biofiltration BMPs sized to capture and treat the Stormwater Quality Design Volume (SQDV) or the Stormwater Quality design Flow (SQDF) (see [Step 7](#) for guidance on calculating the SQDV and SQDF).

Additional Treatment Control Measures may be integrated into roadway projects if they are used in a treatment train approach with Retention BMPs or Biofiltration BMPs to address the pollutants of concern (see Appendix D for information on the importance of fundamental treatment processes in BMP selection).

- 2) Projects should apply the following measures to the maximum extent practicable and as specified in the local permitting agency's codes:
 - Minimize street width to the appropriate minimum width for maintaining traffic flow and public safety;
 - Use porous pavement or pavers for low traffic roadways, on-street parking, shoulders or sidewalks; and
 - Add tree canopy by planting or preserving trees and shrubs.

2.3 Step 2: Assess Site Conditions

The next step is to collect site information that is critical for the selection and implementation of Retention BMPs, Biofiltration BMPs, and Treatment Control Measures. The following information should be documented: topography, soil type and geology, groundwater, geotechnical considerations, offsite drainage, existing utilities, and Environmentally Sensitive Areas. In addition, soil and infiltration testing should be conducted. Detailed guidance on assessing site conditions can be found in [Section 3.1](#).

2.4 Step 3: Apply Site Design Principles and Techniques

The third step is to apply Site Design Principles & Techniques (see [Section 4](#)). The implementation of LID requires an integrated approach to site design and stormwater management. Traditional approaches to stormwater management planning within the site planning process are not likely to achieve the LID performance standard of the MS4 Permit. The use of the site planning techniques presented in [Section 4](#) (Site Design Principles & Techniques) will help generate a

more hydrologically functional site, maximize the effectiveness of Retention BMPs, and integrate stormwater management throughout the site.

The following criteria should be considered during the early site planning stages:

- Retention BMPs should be considered as early as possible in the site planning process. Hydrology should be a key principle that is integrated into the initial site assessment planning phases. Where flexibility exists, conceptual drainage plans should attempt to route water to areas suitable for Retention BMPs.
- A multidisciplinary approach at the initial phases of the project is recommended and should include planners, engineers, landscape architects, and architects.
- Individual Retention BMPs should be distributed throughout the project site as feasible and may influence the configuration of roads, buildings and other infrastructure.
- Flood and hydromodification control should be considered early in the design stages. Even sites with Retention BMPs will still have runoff that occurs during large storm events, but Retention facilities can have flood and hydromodification control benefits. It may be possible to simultaneously address flood and hydromodification control requirements through an integrated water resources management approach.

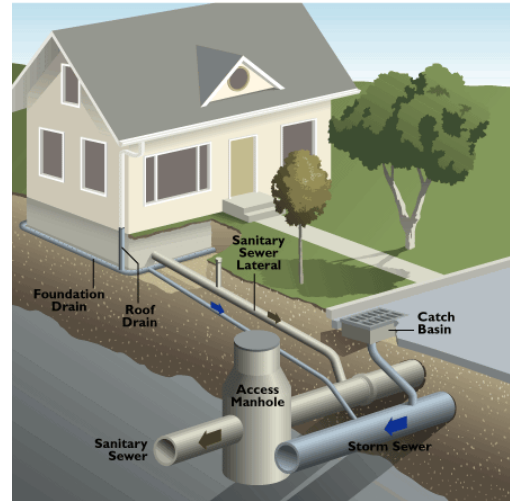
Perhaps the most important aspect of site planning is allowing sufficient space for Retention BMPs in areas that can physically accept runoff. A simple rule of thumb is to allow 3 to 10 percent of the tributary impervious area (depending on how well the soils drain and then allow for more area with less infiltrative soils) for infiltration BMPs and 3 to 5 percent for biofiltration in preliminary design to achieve the 5% Effective Impermeable Area (EIA) standard.

2.5 Step 4: Apply Source Control Measures

All applicable projects must implement applicable Source Control Measures. Source Control Measures are operational practices that reduce potential pollutants at the source. They typically do not require maintenance or significant construction. Guidance on Source Control Measures can be found in [Section 5](#).

2.6 Step 5: Apply BMPs to Reduce EIA to $\leq 5\%$

According to [Order R4-2010-0108](#), Applicable projects must reduce Effective Impervious Area (EIA) to less than or equal to five percent ($\leq 5\%$) of the total project area, unless infeasible. Impervious surfaces are rendered “ineffective” if the design storm volume is fully retained onsite using either infiltration, reuse, and/or evapotranspiration Retention BMPs. Biofiltration BMPs may be used to achieve the 5% EIA standard if Retention BMPs are technically infeasible (see [Section 3.2](#)). This section and [Figure 2-2](#) describe the process for reducing EIA to $\leq 5\%$.



Effective Impervious Area
Victoria, BC Capital Regional District

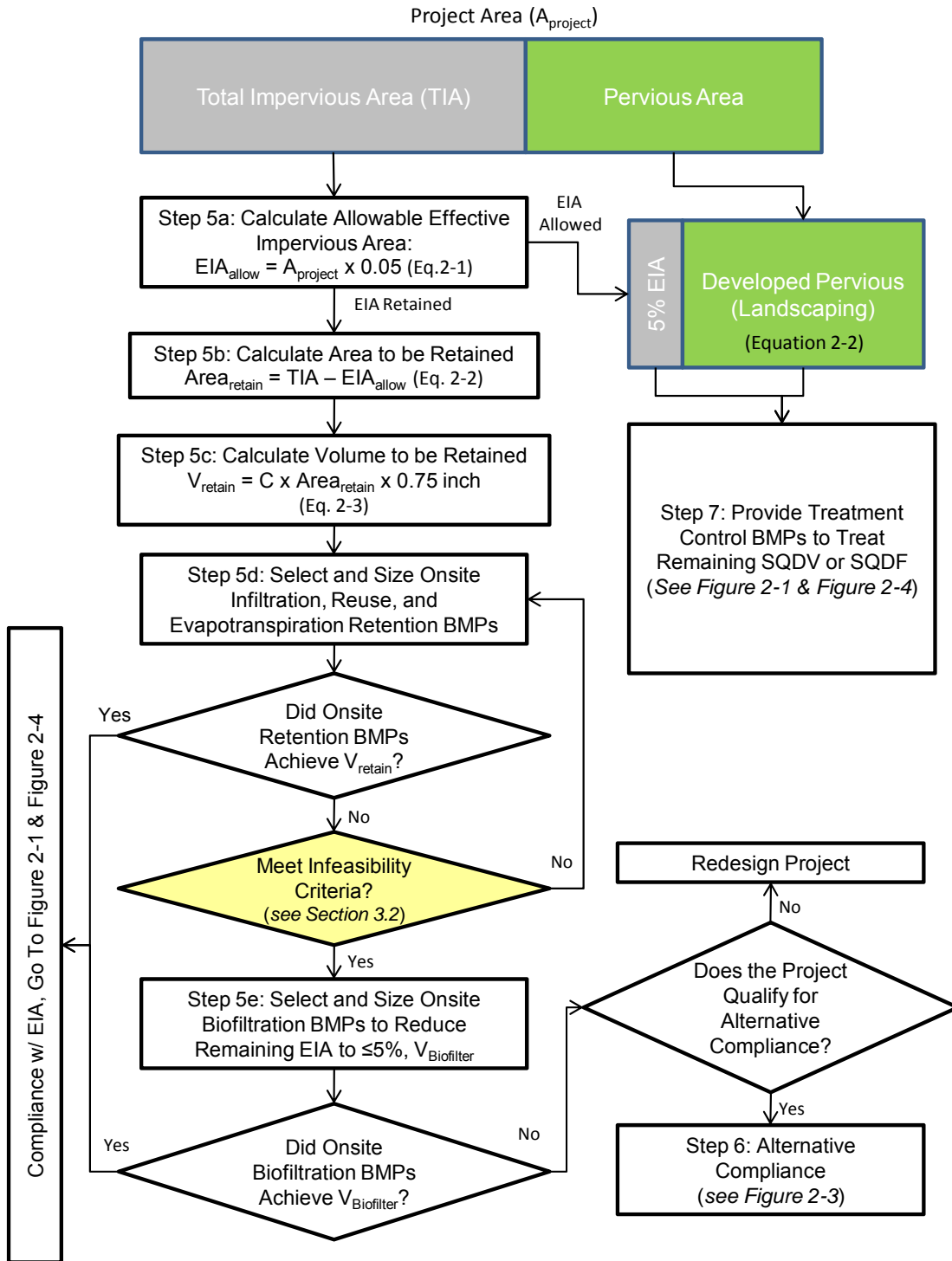


Figure 2-2: Apply BMPs to Reduce EIA to ≤5% Process Flow Chart

Step 5a: Calculate Allowable EIA



EIA is defined as impervious area that is hydrologically connected via sheet flow over a hardened conveyance or impervious surface without any intervening medium to mitigate flow volume. Connected impervious areas efficiently transport runoff without allowing infiltration. Often in urban areas, runoff from connected impervious surfaces is immediately directed into a stormwater conveyance system where it is further connected and efficiently transported to an outfall (stormwater conveyance system outlet). For example, in this illustration, the rooftop is directly connected via a roof drain and underground solid drain pipe to the storm drain in the street (Note that the sanitary sewer is separate from the storm sewer). The roadway drains to the storm drain through the catch basin. The roof area and roadway area would be considered EIA.

“Impervious surface” is a man-made hard surface area which causes water to run off the surface in greater quantities or at an increased rate of flow from the flow present under natural conditions prior to development. Common impervious surfaces include, but are not limited to, rooftops, walkways, patios, driveways, parking lots or storage areas, concrete or asphalt paving, compacted gravel roads, packed earthen materials, and oiled, macadam or other surfaces which similarly impede the natural infiltration of stormwater. Open, uncovered retention/detention facilities and exposed bedrock shall not be considered as impervious surfaces for purposes of determining EIA retention volume.

The allowable EIA for a project site can be calculated as follows:

$$EIA_{\text{allowable}} = (A_{\text{project}}) * (\%_{\text{allowable}}) \quad \text{(Equation 2-1)}$$

Where:

- $EIA_{\text{allowable}}$ = the maximum impervious area from which runoff can be treated and discharged offsite [and not retained onsite] (acres)
- A_{project} = the total project area (acres). “Total project area” for new development and redevelopment projects is defined as the disturbed, developed, and undisturbed portions within the project’s property (or properties) boundary, at the project scale submitted for first approval
- $\%_{\text{allowable}}$ = 5 percent

Step 5b: Calculate Impervious Area to be Retained

The impervious area from which runoff must be retained onsite is the total impervious area minus the $EIA_{allowable}$, which can be calculated as follows:

$$A_{Retain} = TIA - EIA_{allowable} = (IMP * A_{project}) - EIA_{allowable} \quad \text{(Equation 2-2)}$$

Where:

- A_{Retain} = the drainage area from which runoff must be retained (acres)
- TIA = total impervious area (acres)
- $EIA_{allowable}$ = the maximum impervious area from which runoff can be treated and discharged offsite [and not retained onsite] (acres).
- IMP = imperviousness of project area (%) / 100
- $A_{project}$ = the total project area (acres)

EXAMPLE 2-1: EIA CALCULATION

Given: 10 acre total project area, 55% impervious, 25% landscaped, 20% undisturbed, percent allowable EIA = 5%.

$$EIA_{allowable} = 10 * 0.05 = 0.5 \text{ acres}$$

$$A_{Retain} = (0.55 * 10) - 0.5 = 5.0 \text{ acres}$$

$$A_{treatment} = (0.25 * 10) + 0.5 = 3.0 \text{ acres}$$

The maximum EIA allowed for the site is 0.5 acres, from which the generated runoff must be treated prior to discharge, in addition to the runoff from the 2.5 acres landscaped area, up to the design storm volume or flow rate. The runoff volume generated from the remaining 5 acre impervious area (A_{Retain}) must be retained onsite via infiltration, reuse, and/or evapotranspiration Retention BMPs.

$A_{treatment}$ equals the EIA allowed for the site plus the landscaped area.

Step 5c: Calculate the Volume to be Retained (SQDV)

All Retention BMPs used to render impervious surfaces "ineffective" should be properly sized to retain the volume of water that results from the water quality design storm. The design storm volume, referred to in the TGM as the [Stormwater Quality Design Volume \(SQDV\)](#) can be calculated using the following four allowable methodologies:

- 1) The 85th percentile 24-hour runoff event determined as the maximized capture stormwater volume for the area using a 48 to 72-hour draw down time, from the formula recommended in Urban Runoff Quality Management, WEF Manual of Practice No. 23/ASCE Manual of Practice No. 87, (1998); or
- 2) The volume of annual runoff based on unit basin storage water quality volume to achieve 80 percent or more volume treatment; or
- 3) The volume of runoff produced from a 0.75 inch storm event; or
- 4) Eighty (80) percent of the average annual runoff volume using an appropriate public domain continuous flow model [such as Storm Water Management Model (SWMM) or Hydrologic Engineering Center – Hydrologic Simulation Program – Fortran (HEC-HSPF)], using the local rainfall record and relevant BMP sizing and design data.

Note: Examples used throughout the 2010 TGM use the 0.75 inch storm event (Methodology #3).

The runoff volume that is to be retained onsite can be calculated using Equation 2-3 below:

$$V_{\text{Retain}} = C * (0.75/12) * A_{\text{Retain}} \quad \text{(Equation 2-3)}$$

Where:

- V_{Retain} = the stormwater quality design volume (SQDV) that must be retained onsite (ac-ft)
- C = runoff coefficient (equals 0.95 for impervious surfaces)
- 0.75 = the design rainfall depth (in) [based on SQDV sizing method 3]
- A_{Retain} = the drainage area from which runoff is retained (acres), calculated using Equation 2-2

EXAMPLE 2-2: RETENTION VOLUME CALCULATION

Given: $A_{\text{Retain}} = 5.0$ acres (from Example 2-1); runoff coefficient (C) = 0.95

$$V_{\text{Retain}} = 0.95 * (0.75/12) * 5.0 \text{ acres} = 0.3 \text{ acre-feet}$$

The project must retain at least 0.3 acre-feet of runoff from impervious surfaces using Retention BMPs.

Step 5d: Select and Size Onsite Retention BMPs to Achieve 5% EIA

The next step is to select and size Retention BMPs, based on the site assessment design, and constraints. [Section 3-4](#) provides guidance on the selection of Retention BMPs.

Step 5e: Select and Size Biofiltration BMPs to Reduce EIA to ≤5%

Retention BMPs must be used onsite to the maximum extent practicable. Projects that demonstrate [technical infeasibility](#) for reducing EIA to ≤5% using Retention BMPs are eligible to use Biofiltration BMPs to achieve the EIA performance standard.

The project applicant must demonstrate [technical infeasibility](#) by submitting a site-specific analysis conducted and endorsed by a registered professional engineer, geologist, architect, and/or landscape architect. [Section 3.2](#) discusses technical feasibility screening criteria. Projects that cannot demonstrate technical infeasibility must meet the requirement to reduce EIA to ≤5% using Retention BMPs. Otherwise project applicants must examine other options for meeting the requirements, such as redesigning the site.

Biofiltration BMPs must be sized to treat 1.5 times the volume not retained using Retention BMPs.

The onsite biofiltered volume ($V_{\text{Biofilter}}$), can be calculated as follows:

$$V_{\text{Biofilter}} = (V_{\text{Retain}} - V_{\text{Achieved}}) * 1.5 \quad \text{(Equation 2-4)}$$

Where:

- $V_{\text{Biofilter}}$ = the volume that must be captured and treated in a Biofiltration BMP (ac-ft)
- V_{Retain} = the stormwater quality design volume (SQDV) that must be retained (ac-ft) (established in Step 5c)
- V_{Achieved} = the volume retained onsite using Retention BMPs (ac-ft)

EXAMPLE 2-3: BIOFILTRATION VOLUME CALCULATION

Given: $V_{\text{Retain}} = 0.3$ ac-ft (from Example 2-2); $V_{\text{Achieved}} = 0.25$ ac-ft

$$V_{\text{Biofilter}} = (0.3 - 0.25) * 1.5 = 0.075 \text{ ac-ft}$$

If the project applicant has demonstrated technical infeasibility, the remaining EIA requirement may be met by biofiltering 1.5 times the remaining V_{Retain} . In this case, the Biofiltration BMP must be sized to treat 0.075 ac-ft.

2.7 Step 6: Alternative Compliance

Certain new development and redevelopment project types are eligible for alternative compliance measures if onsite Retention BMPs and Biofiltration BMPs cannot feasibly be used to meet the 5% EIA standard. Such projects include:

- 1) Redevelopment projects (as defined in [Section 1.5](#)).
- 2) Infill projects. Infill projects meet the following conditions:
 - a. The project is consistent with applicable general plan designation, and all applicable general plan policies, and applicable zoning designation and regulations;
 - b. The proposed development occurs on a project site of no more than five acres substantially surrounded by urban uses;
 - c. The project site has no value as habitat for endangered, rare, or threatened species;
 - d. Approval of the project would not result in any significant effects relating to traffic, noise, air quality, or water quality; and
 - e. The site can be adequately served by all required utilities and public services (modified from State Guidelines § 15332).
- 3) Smart Growth projects. Smart Growth projects are defined as new development and redevelopment projects that occur within existing urban areas (see maps in Appendix B) designed to achieve the majority of the following principles¹).

¹ Adapted from the Smart Growth Network's Smart Growth Principles in cooperation with the United State Environmental Protection Agency.

- a. Create a range of housing opportunities and choices;
- b. Create walkable neighborhoods;
- c. Mix land uses;
- d. Preserve open space, natural beauty, and critical areas;
 - i. Farmland preservation may also be considered for projects occurring outside the City Urban Restriction Boundary (CURB) but within existing urban centers (as defined by the Appendix B maps)
- e. Provide a variety of transportation choices;
- f. Strengthen and direct development towards existing communities (as defined by Appendix B maps); and
- g. Take advantage of compact building design.

The City or County Planning Division in which a project is proposed will ultimately determine whether a project meets these Smart Growth criteria.

- 4) Pedestrian/bike trail projects.
- 5) Agency' flood control, drainage, and wet utilities projects.
- 6) Historical preservation projects.
- 7) Transit oriented development (within 1/2 mile of transit center).
- 8) Low income housing projects.

Projects in these categories must demonstrate that full compliance with the 5% EIA standard using Retention BMPs and Biofiltration BMPs is infeasible prior to moving to the alternative compliance flowchart (Figure 2-3) and selecting an offsite mitigation alternative. [Section 3.2](#) provides infeasibility criteria.

Stormwater runoff from impervious surfaces and developed pervious surfaces that is not fully retained onsite (up to the SQDV) shall be mitigated using Treatment Control Measures [[Chapter 6](#)] selected per the BMP selection process outlined in [Section 3.4](#).

Alternative compliance may be met through two options:

- Offsite mitigation project; or
- Offsite mitigation fee.

In either case, the Project applicant must contact the local approval agency before proceeding with Alternative Compliance.

Mitigation Volume

Projects requesting alternative compliance must demonstrate that EIA has been reduced to the maximum extent practicable. Additionally, the SQDV or SQDF from all directly connected impervious area and the developed pervious project area must be captured and treated within the project site.

Alternative compliance options will be based on the “mitigation volume.” The mitigation volume is the difference between the volume of runoff associated with 5% EIA and the volume of runoff associated with the actual EIA achieved onsite less than or equal to 30% ($\leq 30\%$) EIA. The offsite mitigation requirement for EIA in excess of 30% ($>30\%$) is 1.5 times the amount of stormwater not managed onsite.

Projects Feasible to Reduce EIA to $\leq 30\%$

- 1) Determine the volume of runoff that is retained and biofiltered onsite ($V_{Ret/Bio}$), using Equation 2-5 below:

$$V_{Ret/Bio} = (V_{Achieved} + (V_{Biofiltered}/1.5)) \quad \text{(Equation 2-5)}$$

Where:

- $V_{Ret/Bio}$ = the total volume of runoff retained and/or biofiltered onsite using Retention and Biofiltration BMPs
- $V_{Achieved}$ = the runoff volume retained onsite using Retention BMPs as calculated in [Equation 2-4](#)
- $V_{Biofiltered}$ = the runoff volume biofiltered onsite

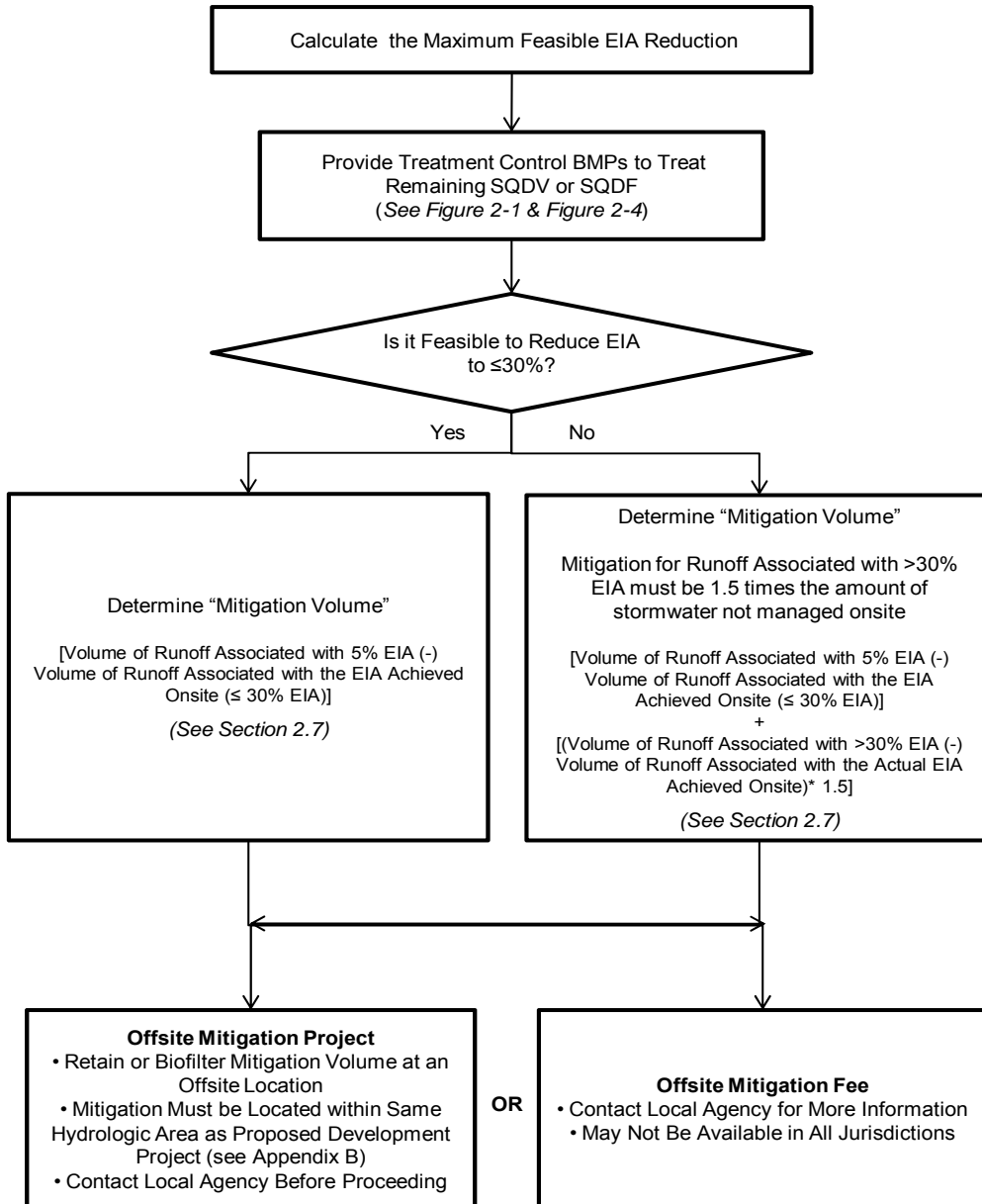


Figure 2-3: Alternative Stormwater Management Control Measures Compliance Decision Flow Chart

2) Determine the Mitigation Volume ($V_{\text{Mitigation}}$), using Equation 2-6 below:

$$V_{\text{Mitigation}} = V_{\text{Retain}} - V_{\text{Ret/Bio}} \quad \text{(Equation 2-6)}$$

Where:

- $V_{\text{Mitigation}}$ = the volume of runoff that must be mitigated offsite
- V_{Retain} = the SQDV that must be retained onsite per the 5% EIA requirement calculated in [Equation 2-3](#)
- $V_{\text{Ret/Bio}}$ = the total volume of runoff retained and/or biofiltered onsite using Retention and Biofiltration BMPs calculated in [Equation 2-5](#)

EXAMPLE 2-4: ≤30% EIA OFFSITE MITIGATION VOLUME CALCULATION

Given: $V_{\text{Retain}} = 0.3$ ac-ft (from Example 2-2); $V_{\text{Retained}} = 0.25$ ac-ft; $V_{\text{Biofiltered}} = 0.06$ ac-ft

1) Calculate volume of runoff retained and biofiltered onsite ($V_{\text{Ret/Bio}}$).

$$V_{\text{Ret/Bio}} = 0.25 + (0.06/1.5) = 0.29 \text{ ac-ft} \quad \text{[See [Equation 2-5](#)]}$$

2) Calculate Mitigation Volume: ($V_{\text{Mitigation}}$):

$$V_{\text{Mitigation}} = 0.3 - 0.29 = 0.01 \text{ acre-feet} \quad \text{[See Equation 2-6]}$$

The required offsite mitigation volume is 0.01 ac-ft.

In addition, the SQDV or SQDF from the EIA (0.5 acres) and the pervious area (10 acres * 25% = 2.5 acres) must be captured and treated in an approved Treatment Control Measure.

$$\text{SQDV (acre-feet)} = C * (0.75/12) * 3 \text{ acres}$$

OR

$$\text{SQDF (cfs)} = C * 0.20 \text{ in/hr} * 3 \text{ acres}$$

Note: Per [Order R4-2010-0108](#), several options exist to determine the SQDV and SQDF. Examples used throughout the 2010 TGM use the 0.75 inch storm event ([SQDV Methodology #3](#)) for the SQDV and 0.2 inches per hour intensity for the SQDF ([SQDF Methodology #1](#)).

Projects with EIA > 30%

For the scenario where the effective impervious area of the project is greater than 30% due to infeasibility, the runoff volume associated with the effective impervious area up to 30% must be mitigated offsite at a one-to-one ratio and the runoff volume associated with the effective impervious area greater than 30% must be mitigated off-site at 1.5 times the volume.

- 1) Determine the area of the impervious portion of the drainage area from which runoff is retained or biofiltered at 30% EIA ($A_{30\%EIA}$), using Equation 2-7 below:

$$A_{30\%EIA} = (IMP * A_{project}) - (30\% * A_{project}) \quad \text{(Equation 2-7)}$$

Where:

$A_{30\%EIA}$ = the impervious portion of the drainage area from which runoff would have been retained or biofiltered at 30% EIA (acres)

IMP = total imperviousness of project area (%) / 100

$A_{project}$ = the total project area (acres)

- 2) Determine the total volume that would have been retained or biofiltered onsite at 30% EIA ($V_{30\%EIA}$), using Equation 2-8 below:

$$V_{30\%EIA} = C * (0.75 / 12) * A_{30\%EIA} \quad \text{(Equation 2-8)}$$

Where:

$V_{30\%EIA}$ = the stormwater quality design volume (SQDV) retained or biofiltered at 30% EIA (note: for the purposes of this calculation, the biofiltered volume does not include the 1.5 multiplier)

C = runoff coefficient [equals 0.95 for impervious surfaces]

0.75 = the design rainfall depth (in) [based on SQDV sizing method 3]

$A_{30\%EIA}$ = the impervious area from which runoff would have been retained or biofiltered at 30% EIA (acres) [See [Equation 2-7](#)]

- 3) Determine the impervious area from which runoff is actually retained ($A_{ActualEIA}$). This is the total amount of impervious area that drains to properly sized Retention or Biofiltration BMPs.

$$A_{ActualEIA} = (IMP * A_{project}) - (EIA\% * A_{project}) \quad \text{(Equation 2-9)}$$

Where:

- $A_{\text{ActualEIA}}$ = the impervious portion of the drainage area from which runoff is retained or biofiltered using the actual EIA achieved on-site (acres)
- IMP = total imperviousness of project area (%) / 100
- A_{project} = the total project area (acres)
- EIA% = percent EIA actually achieved on-site

4) Determine the volume that is actually retained onsite ($V_{\text{ActualEIA}}$), using Equation 2-9 below:

$$V_{\text{ActualEIA}} = C * (0.75 / 12) * A_{\text{ActualEIA}} \quad \text{(Equation 2-10)}$$

Where:

- $V_{\text{ActualEIA}}$ = the stormwater quality design volume (SQDV) that is retained and/or biofiltered onsite C = runoff coefficient [equals 0.95 for impervious surfaces]
- 0.75 = the design rainfall depth (in) [based on SQDV sizing method 3]
- $A_{\text{ActualEIA}}$ = the area associated with the Actual EIA achieved onsite, (i.e., the area from which runoff is retained or biofiltered (acres) [See # 3 above]

Determine the Mitigation Volume for 30% EIA using Equation 2-10 below:

$$V_{\text{Mitigation30\%}} = V_{\text{Retain}} - V_{30\%EIA} \quad \text{(Equation 2-11)}$$

Where:

- $V_{\text{Mitigation30\%}}$ = the mitigation volume for Project site with 30% EIA
- V_{Retain} = the SQDV that must be retained onsite per the 5% EIA requirement, calculated using Equation 2-3
- $V_{30\%EIA}$ = the runoff that would have been retained and/or biofiltered at 30% EIA (note: for the purposes of this calculation, the biofiltered volume does not include the 1.5 multiplier), calculated using Equation 2-8

Determine the Mitigation Volume for >30% (EIA $V_{\text{Mitigation>30\%}}$), using Equation 2-11 below:

$$V_{\text{Mitigation>30\%}} = (V_{30\%EIA} - V_{\text{ActualEIA}}) * 1.5 \quad \text{(Equation 2-12)}$$

Where:

- $V_{\text{Mitigation}>30\%}$ = the mitigation volume for >30% EIA
- $V_{30\%EIA}$ = the stormwater quality design volume (SQDV) retained or biofiltered at 30% EIA (note: for the purposes of this calculation, the biofiltered volume does not include the 1.5 multiplier)
- $V_{\text{ActualEIA}}$ = the stormwater quality design volume (SQDV) that is actually retained and/or biofiltered onsite, calculated using [Equation 2-9](#)

Determine the Total Mitigation Volume ($V_{\text{MitigationTotal}}$), using [Equation 2-13](#) below:

$$V_{\text{MitigationTotal}} = V_{\text{Mitigation}>30\%} + V_{\text{Mitigation}30\%} \quad \text{(Equation 2-13)}$$

Where:

- $V_{\text{MitigationTotal}}$ = the total mitigation volume for 30% EIA
- $V_{\text{Mitigation}>30\%}$ = the mitigation volume for >30% EIA, calculated using [Equation 2-11](#)
- $V_{\text{Mitigation}30\%}$ = the mitigation volume for 30% EIA calculated using [Equation 2-10](#).

EXAMPLE 2-5: >30% EIA OFFSITE MITIGATION CALCULATION

Given: 10 acre total project area, 55% impervious, 25% landscaped, 20% undisturbed; runoff coefficient (C) = 0.95; 40% EIA; $V_{\text{Retain}} = 0.3$ ac-ft

- 1) Determine impervious area retained or biofiltered onsite at 30% EIA
 $A_{30\%EIA} = ((55/100)*10) - ((30/100)*10) = 2.5$ acres [See [Equation 2-7](#)]
- 2) Determine the volume that is retained or biofiltered onsite at 30% EIA
 $V_{30\%EIA} = 0.95*(0.75/12)*2.5 = 0.15$ ac-ft [See [Equation 2-8](#)]
- 3) Determine the impervious area from which runoff is actually retained
 $A_{\text{ActualEIA}} = ((55/100)*10) - ((40/100)*10) = 1.5$ acres [See [Equation 2-9](#)]
- 4) Determine the volume that is actually retained or biofiltered onsite
 $V_{\text{ActualEIA}} = 0.95*(0.75/12)*1.5 = 0.09$ ac-ft [See [Equation 2-10](#)]
- 5) Determine Mitigation Volume for 30% EIA
 $V_{\text{Mitigation}30\%} = 0.3 - 0.15 = 0.15$ ac-ft [See [Equation 2-11](#)]
- 6) Determine Mitigation Volume for >30%
 $V_{\text{Mitigation}>30\%} = (0.15-0.09) *1.5 = 0.09$ ac-ft [See [Equation 2-12](#)]
- 7) Determine the Total Mitigation Volume
 $V_{\text{MitigationTotal}} = 0.15 + 0.09 = 0.24$ ac-ft [See [Equation 2-13](#)]

The required offsite mitigation volume is 0.24 ac-ft

Selecting Offsite Mitigation Projects


Project applicants may identify offsite mitigation projects. Project applicants are responsible for completing offsite mitigation projects that will retain the mitigation volume. Offsite mitigation projects must adhere to the following criteria:

- Offsite mitigation projects must be located within the same hydrologic area (see map in Appendix B)
- Offsite mitigation projects should mitigate similar (or higher) pollutant-loading land uses, if possible.
- Offsite mitigation projects must be completed as soon as possible and at the latest, within 4 years of the certificate of occupancy for the original project.

Examples of Offsite Mitigation Projects

Mitigation projects should target urbanized areas that were developed without stormwater mitigation. All projects must be approved by the local permitting agency


and must adhere to the BMP Selection Criteria presented in [Section 3.4](#) of the 2010 TGM. Potential project types may include:

- Convert a convex parking lot landscaped island into a depressed bioretention area designed to retain parking lot runoff.
- Convert a traditionally-paved parking lot into porous pavement.
- Modify an existing detention pond into a retention pond.
- Install bioretention in bump outs, in parkways, or in roadway medians.
- Install bioretention in sidewalk areas to infiltrate roof, sidewalk, and/or roadway runoff. Sidewalks must be wide enough to permit foot traffic around bioretention area.
- Incorporate infiltration BMPs into landscaped areas that collect runoff from impervious surfaces. 

Offsite Mitigation Fee

In some cases, Alternative Compliance may be achieved through an Offsite Mitigation Fee. A list of offsite mitigation projects available for funding will be identified by the Approval Agencies. Applicants should contact their local Approval Agency for more information. The Offsite Mitigation Fee may not be available in all jurisdictions.

2.8 Step 7: Apply Treatment Control Measures

Stormwater runoff from EIA and developed pervious surfaces shall be mitigated using Retention BMPs, Biofiltration BMPs, or Treatment Control Measures  [Chapter 6] selected per the BMP selection process outlined in [Section 3.4](#) and Figure 2-4. Biofiltration BMPs and Treatment Control Measures may be sized to meet the Stormwater Quality Design Volume (SQDV) or the Stormwater Quality Design Flow (SQDF). See Appendix D for guidance on sizing BMPs to meet both the retention and treatment control sizing standards.

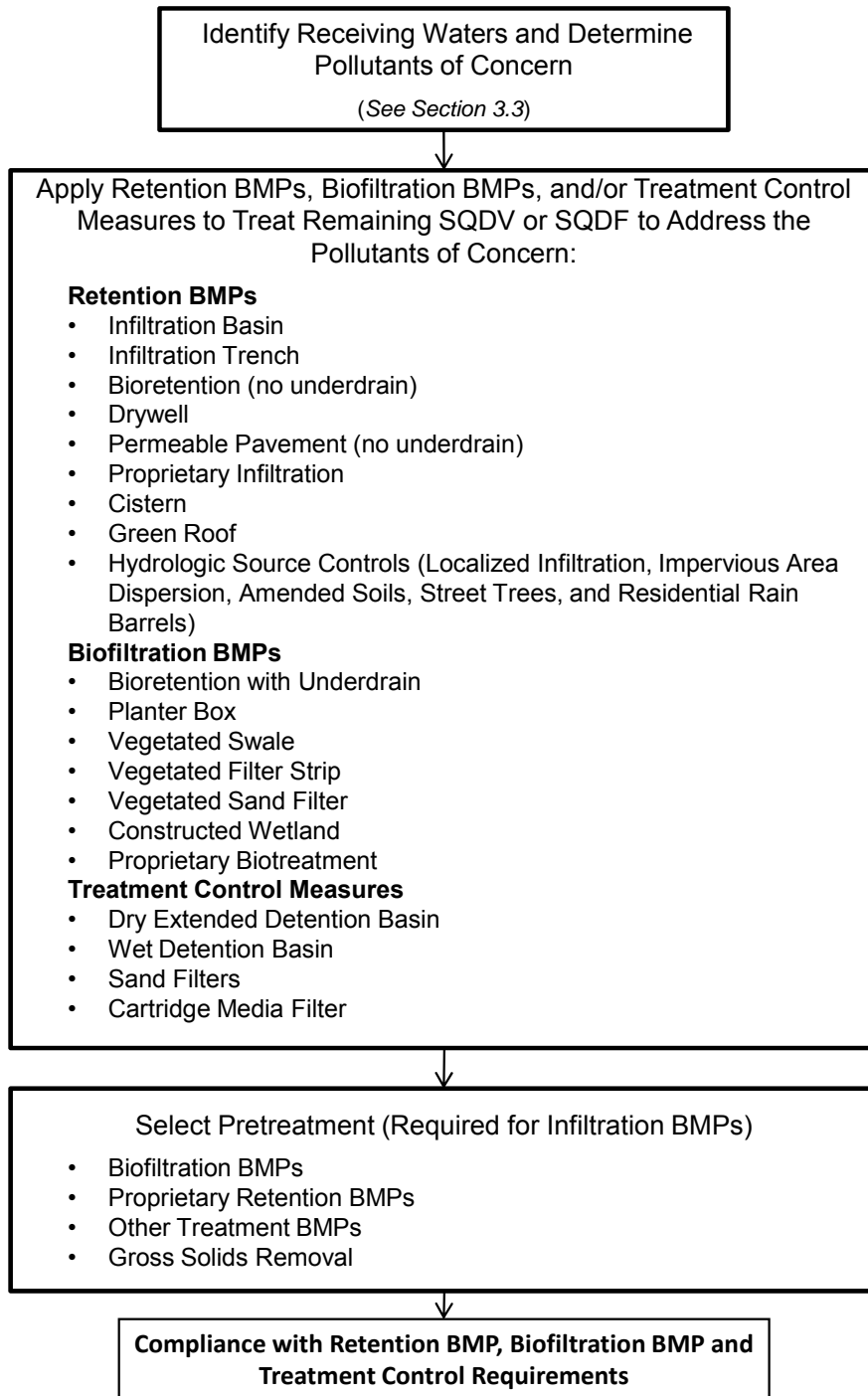


Figure 2-4: Apply Retention BMPs, Biofiltration, or Treatment Control BMPs to Treat Remaining SQDV or SQDF

Stormwater Quality Design Volume (SQDV)

Volume-based Treatment Control Measures must be sized to capture and treat the runoff volume from the water quality design storm. The SQDV can be calculated using the following four allowable methodologies:

- 1) The 85th percentile 24-hour runoff event determined as the maximized capture stormwater volume for the area using a 48 to 72-hour draw down time, from the formula recommended in Urban Runoff Quality Management, WEF Manual of Practice No. 23/ASCE Manual of Practice No. 87, (1998); or
- 2) The volume of annual runoff based on unit basin storage water quality volume to achieve 80 percent or more volume treatment; or
- 3) The volume of runoff produced from a 0.75 inch storm event; or
- 4) Eighty (80) percent of the average annual runoff volume using an appropriate public domain continuous flow model [such as Storm Water Management Model (SWMM) or Hydrologic Engineering Center – Hydrologic Simulation Program – Fortran (HEC-HSPF)], using the local rainfall record and relevant BMP sizing and design data.

The allowable design storm calculation methodology is determined by the project size, as summarized in Table 2-1 below:

Table 2-1: Allowed Design Storm Methodology Based on Project Size

Project Size (Disturbed Land Area¹)	Allowed Design Storm Methodology
Less than 5 acres	(1), (2), (3), or (4)
5 acres - 50 acres	(1), (2), or (4)
More than 50 acres	(4)

¹ “Disturbed Area” means any area that is altered as a result of land disturbance, such as clearing, grading, grubbing, stockpiling or excavation.

Instructions for calculating the SQDV based on method (3), the volume of runoff produced from a 0.75 inch storm event, are provided below. Instructions for calculating the SQDV for methods (1), (2), and (4) are provided in Appendix E.

Calculation Procedure

- 1) Determine the area from which runoff must be retained or captured and treated ($A_{project}$).
- 2) Determine the runoff coefficient (C), using Equation 2-13 below:

$$C = 0.95 \cdot imp + C_p (1 - imp) \tag{Equation 2-13}$$

Where:

- C = runoff coefficient (equals 0.95 for impervious surfaces)
- imp = impervious fraction of watershed
- C_p = pervious runoff coefficient, determined based on soil type using table below:

Ventura Soil Type (Soil Number)	C _p value
1	0.15
2	0.10
3	0.10
4	0.05
5	0.05
6	0
7	0

- 3) Determine the stormwater runoff design volume (SQDV), using Equation 2-14 below:

$$SQDV = C \cdot (0.75/12)^* A_{\text{project}} \quad \text{(Equation 2-14)}$$

Where:

- SQDV = the stormwater quality design volume (acre-feet)
- C = runoff coefficient, calculated by Equation 2-13
- 0.75 = the design rainfall depth (in) [based on sizing method (3)]Atrib
- A_{project} = drainage area of the tributary catchment (acres)

Stormwater Quality Design Flow (SQDF)

For the purposes of the 2010 TGM, instructions for calculating the SQDF based on method (1), the flow of runoff produced from a rainfall event equal to at least 0.2 inches per hour intensity, are provided below. Instructions for calculating the SQDF for methods (2), and (3) are provided in Appendix E.

Calculation Procedure

- 1) Determine the drainage area from which the flow-based BMP will be receiving runoff (A_{project}).

- 2) Calculate the runoff coefficient (C), using [Equation 2-13](#).
- 3) Calculate the SQDF using Equation 2-15 below:

$$SQDF = C * I * A_{project} \quad \text{(Equation 2-15)}$$

Where:

- SQDF = flow in cubic feet per second (cfs)
- C = runoff coefficient, calculated by [Equation 2-13](#) above
- I = average rainfall intensity (inches/hour) for a duration equal to the time of concentration of the watershed [equal to 0.2 in/hr for method (1)]
- $A_{project}$ = drainage area of the tributary catchment (acres)

2.9 Step 8: Continue Project Design Process: Flood Control and Hydromodification Requirements

The project applicant should continue with the design process to address additional requirements including flood control and hydromodification control criteria.

Step 8a: Flood Control Requirements

Applicants shall comply with Ventura County and local approval agency regulations on floodplain and floodway management.


Step 8b: Hydromodification (Flow/Volume/Duration) Control Criteria

Projects meeting the applicability criteria contained in Section 4.E.II of [Order R4-2010-0108](#) (presented in [Section 1.5](#) of the 2010 TGM) are required to implement hydrologic control measures to prevent accelerated erosion and to protect stream habitat in downstream natural drainage systems. Natural drainage systems are defined as unlined or unimproved (not engineered) creeks, streams, rivers and their tributaries.

Exemptions

The following new development and redevelopment projects are exempt from the hydromodification control criteria:

- 1) Single-family structures, unless such projects disturb one acre or more of land or create, add, or replace 10,000 square feet or more of impervious surface area.
- 2) All projects that disturb less than one acre.

- 3) Projects that are replacement, maintenance, or repair of an Agency's existing flood control facility, storm drain, or transportation network.
- 4) Redevelopment projects in existing urban centers [see maps in Appendix B] that do not increase the effective impervious area or decrease the infiltration capacity of pervious areas compared to **the pre-project condition.** 
- 5) Projects that have any increased discharge directly or via a storm drain to a sump, lake, area under tidal influence, into a waterway that has a 100-year peak flow (Q100) of 25,000 cubic feet per second (cfs) or more, or other receiving water that is not susceptible to hydromodification impacts.
- 6) Projects that discharge directly or via a storm drain into concrete or improved (not natural) channels (e.g., rip rap, sackcrete, etc.), which, in turn, discharge into receiving water that is not susceptible to hydromodification impacts (as in #5 above).

Hydromodification Control Measures

The purpose of Hydromodification Control Measures is to minimize changes in post-development stormwater runoff discharge rates, velocities, and durations by maintaining within a certain tolerance, the project's pre-project stormwater runoff flow rates and durations.

Hydromodification Control Measures may include onsite, subregional, or regional Hydromodification Control Measures, Retention BMPs, or stream restoration measures. Preference must be given to onsite Retention BMPs and Hydromodification Control Measures. In-stream restoration measures may not adversely affect the beneficial uses of natural drainage systems.

The Southern California Stormwater Monitoring Coalition (SMC) is developing a regional methodology to eliminate or mitigate the adverse impacts of hydromodification as a result of urbanization, including hydromodification assessment and management tools. The Program will develop and implement watershed-specific Hydromodification Control Plans (HCPs) after the completion of the SMC study. Until the completion of the HCPs, the Interim Hydromodification Control Criteria, described below, apply to applicable, non-exempt new development and redevelopment projects.

Interim Hydromodification Control Criteria

- 1) Projects disturbing less than 50 acres shall comply with the Stormwater Management Standards contained in the 2010 TGM (i.e., a combination of retention, biofiltration, and treatment control measures).
- 2) Projects disturbing 50 acres or greater must develop and implement a Hydromodification Analysis Study (HAS) that demonstrates that post development conditions are expected to approximate the pre-project erosive

effect of sediment transporting flows in receiving waters. The HAS must lead to the incorporation of project design features intended to approximate, to the extent feasible, an Erosion Potential value of 1, or any alternative value that can be shown to be protective of the natural drainage systems from erosion, incision, and sedimentation that can occur as a result of flow increases from impervious surfaces and damage stream habitat in natural drainage systems.

2.10 Step 9: Develop Maintenance Plan

The Ventura Countywide Stormwater Quality Management Program (Program) requires the submittal of a Maintenance Plan and execution of a Maintenance Agreement with the owner/operator of any stormwater control that requires maintenance including Site Design Principles and Techniques (Section 4), Source Control Measures (Section 5), Retention BMPs and Treatment Control Measures (Section 6). Maintenance Plans must include guidelines for how and when inspection and maintenance should occur for each control. [Section 7](#) and Appendices H and I provide additional information and guidance on compliance with maintenance requirements.

3 SITE ASSESSMENT AND BMP SELECTION

3.1 Assessing Site Conditions and Other Constraints

Assessing a site's potential for implementation of Retention BMPs, Biofiltration BMPs, and Treatment Control Measures requires both the review of existing information and the collection of site-specific measurements. Available information regarding site layout and slope, soil type, geotechnical conditions, and local groundwater conditions should be reviewed as discussed below. In addition, soil and infiltration testing should be conducted to determine if stormwater infiltration is feasible and to determine the appropriate design infiltration rates for infiltration-based treatment BMPs.

Site Conditions

Topography

The site's topography should be assessed to evaluate surface drainage and topographic high and low points, as well as to identify the presence of steep slopes that qualify as Hillside Locations. All of these conditions have an impact on what type of Retention BMPs, Biofiltration BMPs, and Treatment Control Measures will be most beneficial for a given project site. Stormwater infiltration is more effective on level or gently sloping sites. Flows on slopes steeper than 15% may runoff as surface flows, rather than infiltrate into the ground. On hillsides, infiltrated runoff may daylight or resurface a short distance downslope, which could cause slope instability depending on the soil or geologic conditions. See the [Geotechnical Considerations](#) section below.

Soil Type and Geology

The site's soil types and geologic conditions should be determined to evaluate the site's ability to infiltrate stormwater and to identify suitable, as well as unsuitable, locations for infiltration-based BMPs (e.g., infiltration basins and trenches, bioretention without an underdrain, permeable pavement, and drywells). Using the Soil Survey completed by the Soil Conservation Service (SCS) (now identified as the Natural Resource Conservation Service [NRCS]) of the U. S. Department of Agriculture in April 1970, soils in Ventura County were grouped into seven hydrologically homogeneous families [see [Ventura County Hydrology Manual](#) (2006); also see Appendix B]. Two families were assigned to each of the NRCS Hydrologic Soil Groups A, B, and C; while only one family was considered appropriate for NRCS Hydrologic Soil Group D [for further information, see <http://soils.usda.gov/>]:

- Group A soils are typically sands, loamy sands, or sandy loams. Group A soils have low runoff potential and high infiltration rates even when thoroughly wetted. They consist chiefly of deep and well to excessively drained sands or gravels and have a high rate of water transmission. Ventura County soil numbers 6 and 7 are Group A soils.
- Group B soils are typically silty loams or loams. They have a moderate infiltration rate when thoroughly wetted and consist chiefly of moderately deep to deep and moderately well to well drained soils with moderately fine to moderately coarse texture. Ventura County soil numbers 4 and 5 are Group B soils.
- Group C soils are typically sandy clay loams. They have low infiltration rates when thoroughly wetted, consist chiefly of soils with a layer that impedes downward movement of water, and/or have moderately fine to fine soil structure. Ventura County soil numbers 2 and 3 are Group C soils.
- Group D soils are typically clay loams, silty clay loams, sandy clays, silty clays, or clays. They have very low infiltration rates when thoroughly wetted and consist chiefly of clay soils with high swelling potential, permanent high water table, claypan or clay layer at or near the surface, and/or shallow soils over nearly impervious material. Ventura County soil number 1 is a Group D soil.

Infiltration-based BMPs should be feasible in areas mapped with Ventura County Soil Numbers 4 through 7. If site-specific data is available, then soils with infiltration rates of 0.5 in/hr or greater are considered feasible for infiltration. Infiltration-based BMPs should not be designed for sites mapped with Ventura County Soil Numbers 1 through 3, or with infiltration rates less than 0.5 in/hr. Flow-through Treatment Control Measures may be designed that incorporate underground storage layers that promote slow infiltration over long periods, in areas with lower infiltration rates.

Early identification of soil types throughout the project footprint can reduce the number of test pit investigations and infiltration tests needed. Early identification reduces the number of potential test sites to locations with those that are most likely to be amenable to infiltration. Guidance for conducting test pit investigations and infiltration tests is provided in Appendix C.

Project applicants should review available geologic or geotechnical reports on local geology to identify relevant features such as depth to bedrock, rock type, lithology, faults, and hydrostratigraphic or confining units. These geologic investigations may also identify shallow water tables and past groundwater issues that are important for BMP design (see below).

Groundwater Considerations

Site groundwater conditions should be considered prior to Retention BMP, Biofiltration BMP, and Treatment Control Measure siting, selection, sizing, and design. The depth to groundwater beneath the project during the wet season may preclude infiltration, since five feet of separation to the seasonal high ground water level and mounded groundwater level is required. Depth to seasonal high groundwater level shall be estimated as the average of the annual minima (i.e., the shallowest recorded measurements in each water year, defined as October 1 through September 30) for all years on record. If groundwater level data are not available or not considered to be representative, seasonal high groundwater depth can be determined by redoximorphic analytical methods combined with temporary groundwater monitoring for November 1 through April 1 at the proposed project site.

In areas with known groundwater pollution, infiltration may need to be avoided, as it could contribute to the movement or dispersion of groundwater contamination. Areas with known groundwater impacts include sites listed by the Los Angeles Regional Water Quality Control Board's Leaking Underground Storage Tanks (LUST) program and Site Cleanup Program (SCP). The California State Water Resources Control Board maintains a database of registered contaminated sites through their ['Geotracker'](#) Program. Registered contaminated sites can be identified in the project vicinity when the site address is typed into the "map cleanup sites" field.

Mobilization of groundwater contaminants may also be of concern where contamination from natural sources is prevalent (e.g., marine sediments, selenium rich groundwater, to the extent that data is available). Infiltration on sites with contaminated soils or groundwater that could be mobilized or exacerbated by infiltration is not allowed, unless a site-specific analysis determines the infiltration would be beneficial. A site-specific analysis may be conducted where groundwater pollutant mobilization is a concern to allow for infiltration-based BMPs.

Research conducted on the effects of stormwater infiltration on groundwater by Pitt et al. (1994) indicate that the potential for contamination due to infiltration is dependent on a number of factors, including the local hydrogeology and the chemical characteristics of the pollutants of concern. Chemical characteristics that influence the potential for groundwater impacts include high mobility (low absorption

potential), high solubility fractions, and abundance of pollutants in urban runoff. As a class of constituents, trace metals tend to adsorb onto soil particles and are filtered out by the soils. This has been confirmed by extensive data collected beneath stormwater detention/retention ponds in Fresno (conducted as part of the Nationwide Urban Runoff Program (Brown & Caldwell, 1984)) that showed that trace metals tended to be adsorbed in the upper few feet in the bottom sediments. Bacteria are also filtered out by soils. More mobile and soluble pollutants, such as chloride and nitrate, have a greater potential for impacting groundwater.

Where soils have very high infiltration rates, groundwater quality may be impacted by infiltration BMPs. Prior to the use of infiltration basins and subsurface infiltration BMPs in areas with high infiltration rates, consult with the local regulatory agencies to identify if unconfined aquifers are located beneath the project to determine the appropriateness of infiltration-based BMPs. In areas underlain by unconfined aquifers with designated beneficial groundwater uses (e.g. drinking water supply), the application of infiltration BMPs should be limited to those that provide significant pretreatment to ensure groundwater is protected from pollutants of concern.

Geotechnical Considerations

Water infiltration can cause geotechnical issues, including: (1) settlement through collapsible soil, (2) expansive soil movement, (3) slope instability, and (4) increased liquefaction hazard. Stormwater infiltration temporarily raises the groundwater level near the infiltration facility, such that the potential geotechnical conditions are likely to be of greatest significance near the infiltration area and decrease with distance. A geotechnical investigation should be performed for the infiltration facility to identify potential geotechnical issues and geological hazards that may result from infiltration.

In general, infiltration-based BMPs must be set back from building foundations or steep slopes. Increased water pressure in soil pores reduces soil strength. Decreased soil strength can make foundations more susceptible to settlement and slopes more susceptible to failure. Recommendations for each site should be determined by a licensed geotechnical engineer based on soils boring data, drainage patterns, and the current requirements for stormwater treatment. Implementing the geotechnical engineer's requirements is essential to prevent damage from increased subsurface water pressure on surrounding properties, public infrastructure, sloped banks, and even mudslides.

Collapsible Soil

Typically, collapsible soil is observed in sediments that are loosely deposited, separated by coatings or particles of clay or carbonate, and subject to saturation. Stormwater infiltration will result in a temporary rise in the groundwater elevation. This rise in groundwater could change the soil structure by dissolving or deteriorating the intergranular contacts between the sand particles, resulting in a sudden collapse, referred to as hydrocollapse. This collapse phenomenon generally

occurs during the first saturation episode after deposition of the soil, and repeated cycles of saturation are not likely to result in additional collapse. It is important to evaluate the potential for hydrocollapse during the geotechnical investigation.

The magnitude of hydrocollapse is proportional to the thickness of the soil column where infiltration is occurring. In most instances, the magnitude of hydrocollapse will be small. Regardless, the geotechnical engineer should evaluate the potential effects of hydrocollapse from large infiltration facilities on nearby structures and roadways. Typically, a network of surface settlement monuments is installed around the infiltration site, along adjacent roadways, and in neighboring developments to evaluate if hydrocollapse has occurred. These monuments are typically monitored prior to infiltrating stormwater, monthly during the first year of operation of the facility, then yearly thereafter for a period of approximately five years.

Expansive Soil

Expansive soil is generally defined as soil or rock material that has a potential for shrinking or swelling under changing moisture conditions. Expansive soils contain clay minerals that expand in volume when water is introduced and shrink when the water is removed or the material is dried. When expansive soil is present near the ground surface, a rise in groundwater from infiltration activities can introduce moisture and cause these soils to swell. Conversely, as the groundwater surface falls after infiltration, these soils will shrink in response to the loss of moisture in the soil structure. The effects of expansive soil movement (swelling and shrinking) will be greatest on near surface structures such as shallow foundations, roadways, and concrete walks. Basements or below-grade parking structures can also be affected as additional loads are applied to the basement walls from the large swelling pressures generated by soil expansion. A geotechnical investigation should identify if expandable materials are present near the proposed infiltration facility, and if they are, evaluate if the infiltration will result in wetting of these materials. See Appendix B, Map B-14 (expansive soil potential map).

Slopes

Slopes near the infiltration facility can be affected by the temporary rise in groundwater. The presence of a water surface near a slope can substantially reduce the stability of the slope from a dry condition. A groundwater mounding analysis should be performed to evaluate the rise in groundwater around the facility. If the computed rise in groundwater approaches nearby slopes, then a separate slope stability evaluation should be performed to evaluate the implications of the temporary groundwater surface. The geotechnical and groundwater mounding evaluations should identify the duration of the elevated groundwater and assign factors of safety consistent with the duration (e.g., temporary or long-term conditions).

Liquefaction

Seismically-induced soil liquefaction is a phenomenon in which saturated granular materials, typically possessing low to medium density, undergo matrix rearrangement, develop high pore water pressure, and lose shear strength due to cyclic ground motions induced by earthquakes. This rearrangement and strength loss is followed by a reduction in bulk volume. Manifestation of soil liquefaction can include loss of bearing capacity for foundations, surface settlements, and tilting in level ground. Soil liquefaction can also result in instabilities and lateral spreading in embankments and areas of sloping ground.

Saturation of the subsurface soils above the existing groundwater table may occur as a result of stormwater infiltration. A groundwater mounding analysis should also evaluate the duration of mounding, as a lengthy duration or long-term rise in groundwater will need to be considered in the evaluation of liquefaction. If the granular soils are sufficiently dense, it is unlikely that liquefaction will be of concern, regardless of the groundwater mounding. If analyses indicate that the potential for liquefaction may be increased from stormwater infiltration, then the analyses will need to evaluate the liquefaction-induced settlement of structures, lateral spreading, and other surface manifestations. See Appendix B, Map B-14 (liquefaction potential map).

Managing Offsite Drainage

Locations and sources of offsite run-on onto the site should be identified early in the design process. Offsite drainage should be considered when determining appropriate BMPs so that drainage can be managed. Concentrated flows from offsite drainage may cause extensive erosion, if not properly conveyed through or around the project site or otherwise managed. By identifying the locations and sources of offsite drainage, the volume of water running onto the site may be estimated and factored into the siting and sizing of onsite BMPs. Vegetated swales or storm drains may be used to intercept, divert, and convey offsite drainage through or around a site to prevent flooding or erosion that might otherwise occur.

Existing Utilities

Existing utility lines that are onsite will limit the possible locations of certain BMPs. For example, infiltration BMPs should not be located near utility lines where the increased amount of water could damage the utilities. Stormwater should be directed away from existing underground utilities. Project designs that require the relocation of existing utilities should be avoided, if possible.

Environmentally Sensitive Areas



The presence of Environmentally Sensitive Areas (ESAs) may limit the siting of certain BMPs. ESA's are typically delineated by, and fall under the regulatory oversight of state or federal agencies such as the U.S. Army Corp of Engineers (USACE), California Department of Fish and Game, U.S. Fish and Wildlife Service, or the California Environmental Protection Agency. BMP's should be selected and sited

to avoid adversely affecting ESA's. The Ventura County ESA map is provided in Appendix B.

3.2 Technical Feasibility Screening

To use biofiltration BMPs and alternative compliance measures, the project applicant should demonstrate that compliance with the requirement to reduce EIA to $\leq 5\%$ using Retention BMPs are technically infeasible by submitting a site-specific hydrologic and/or design analysis conducted and endorsed by a registered professional engineer, geologist, architect, and/or landscape architect. Projects seeking to use alternative compliance measures must demonstrate EIA has been reduced to the maximum extent practicable. Technical infeasibility may result from conditions including the following:

- 1) Locations where seasonal high groundwater or mounded groundwater beneath an infiltration BMP is within 5 feet of the bottom of the infiltration BMP.
- 2) Locations on the project site where soils are mapped with Ventura Hydrology Manual Soil Numbers 1-3 or site-specific analyses show that the soils have an infiltration rate less than 0.5 inches per hour.
- 3) Locations on the project site within 100 feet of a groundwater well used for drinking water, non-potable wells, drain fields, and springs; locations less than 50 feet away from slopes steeper than 15 percent; and locations less than eight feet from building foundations or an alternative setback established by the geotechnical expert for the project.
- 4) Brownfield development sites or other locations where pollutant mobilization is a documented concern, unless a site-specific analysis determines that infiltration would not be detrimental.
- 5) Locations with potential geotechnical hazards established by the geotechnical professional for the project.
- 6) Projects with high-risk areas such as service/gas stations, truck stops, and heavy industrial sites, unless a site-specific evaluation demonstrates that:
 - Treatment is provided to address pollutants of concern, and/or
 - High risks areas are isolated from stormwater runoff or infiltration areas with little chance of spill migration.
- 7) Locations where reduction of surface runoff may potentially impair beneficial uses of the receiving water as documented in a site-specific study (e.g., California Environmental Quality Act (CEQA) analysis) or watershed plan.

- 8) Location where an increase in infiltration over natural conditions could potentially cause impairments to downstream beneficial uses, such as change of seasonality of ephemeral washes, as confirmed through a site-specific study. 
- 9) Green roofs are not required to be considered for all project locations and types; this evapotranspiration BMP is considered optional subject to the approval of the permitting authority.
- 10) Projects that do not provide sufficient demand for harvested stormwater. Demand estimation shall include consideration of requirements for Title 22 treatment of stormwater for indoor uses, requirements to use reclaimed water for indoor and outdoor uses, and low water use landscaping requirements (see Technical Effectiveness Screening, below)
- 11) BMPs that are not allowable per current federal, state or local codes are considered infeasible.
- 12) The following project types where the density and/or nature of the project would create significant difficulty for compliance with the requirement to reduce EIA to $\leq 5\%$:
 - a. Redevelopment, infill, and Smart Growth projects.
 - b. Pedestrian/bike trail projects.
 - c. Permittee's flood control, drainage, and wet utilities projects.
 - d. Historical preservation projects.
 - e. Transit oriented development (within $\frac{1}{2}$ mile of a transit center). 
 - f. Low income housing.

Determining Maximum Volume Feasibly Retained and Biofiltered

Conditions may exist under which it is technically feasible to retain stormwater to achieve the $\leq 5\%$ EIA performance standard, but a combination of site conditions and constraints make it infeasible to fully retain stormwater to achieve $\leq 5\%$ EIA using Retention BMPs. In such cases, stormwater runoff must be retained to the maximum extent practicable and then the remaining volume must be multiplied by 1.5 and biofiltered to the maximum extent practicable. If SQDV still remains, it may be addressed in an alternative compliance program. This section provides narrative and numeric criteria for determining the "maximized" retention volume for each class of Retention BMPs and the "maximized" volume for biotreatment BMPs. The term "maximized" refers to the volume that is determined, on a case-by-case basis, to be consistent with the maximum extent practicable standard.

Criteria for Maximizing Infiltration Volume

Volume can be considered to be maximized in infiltration BMPs when all of the following conditions are met, or when adjustments to the site/BMP plan to meet any one of these criteria results in achievement of the $\leq 5\%$ EIA performance standard:

- 1) BMPs are designed to the maximum depth allowed by design standards, but are not required to exceed the depth that infiltrates within 48 hours at the design percolation rate. *Explanation: Deeper BMPs provide more volume per footprint area, therefore it is more feasible to retain stormwater in deeper BMPs than shallower BMPs. However, because of the nature of sequential storms in Southern California, the volume provided in excess of that which drains within 48 hours provides significantly diminishing value and may result in long term BMP performance issues.*
- 2) All practicable methods are employed to enhance the design percolation rate, including:
 - Use of soil amendments below BMPs, and
 - Provision of pretreatment to reduce the allowable factor of safety, and
 - Additional site investigation to reduce uncertainty in infiltration rate and allow the use of a lower factor of safety.
- 3) Good site practices have been integrated to provide the maximum pervious area feasible for infiltration BMPs, and infiltration BMPs have been configured to make use of this area. Table 3-1 provides recommended percentages of a site, by project type, that should be feasible to dedicate to infiltration BMPs (where technically feasible) within pervious areas. If the project has not provided this portion of the project site for infiltration BMPs (where technically feasible), an attempt should be made to improve site design to provide more pervious area until it is either infeasible to provide more pervious area or EIA is reduced to $\leq 5\%$. The minimum percent of parking lot pavement area considered feasible to dedicate to permeable pavement (where technically feasible) is 20%; this does not apply to parking lots that anticipate heavy truck traffic such as truck stops and heavy industrial areas.

Table 3-1: Recommended Criteria for Percent of Site Feasible to Dedicate to BMPs

Project Type ¹		Percent of Site
New Development	SF/MF Residential < 7 du/ac	10
	SF/MF Residential 7 – 18 du/ac	7
	SF/MF Residential > 18 du/ac	5
	Mixed Use, Commercial, Institutional/Industrial w/ FAR < 1.0	10
	Mixed Use, Commercial, Institutional/Industrial w/ FAR 1.0 – 2.0	7
	Mixed Use, Commercial, Institutional/Industrial w/ FAR > 2.0	5
	Podium (parking under > 75% of project)	3
	Projects with zoning allowing development to lot lines	2
	Transit Oriented Development	5
	Parking	5
	Redevelopment	SF/MF Residential < 7 du/ac
SF/MF Residential 7 – 18 du/ac		4
SF/MF Residential > 18 du/ac		3
Mixed Use, Commercial, Institutional/Industrial w/ FAR < 1.0		5
Mixed Use, Commercial, Institutional/Industrial w/ FAR 1.0 – 2.0		4
Mixed Use, Commercial, Institutional/Industrial w/ FAR > 2.0		3
Podium (parking under > 75% of project)		2
Projects with zoning allowing development to lot lines		1
Transit Oriented Development		3
Projects in Historic Districts		3

Key: SF = Single Family, MF = Multi Family, du/ac = dwelling units per acre, FAR = Floor Area Ratio = ratio of gross floor area of building to gross lot area,

Criteria for Maximizing Rainwater Harvesting (RWH) Volume

Volume can be considered to be maximized in RWH BMPs when all of the following conditions are met, or when adjustments to the site design or BMP plan to meet any one of these criteria results in achievement of the ≤5% EIA performance standard:

- 1) The provided storage volume is equal to the volume that can be used within 48 hours considering all “allowable and reliable demand.” *Intent: Due to the nature of sequential storms in Southern California, the volume provided in excess of the*

volume that drains within 48 hours provides significantly diminishing value and may result in long term BMP performance issues.

- 2) Allowable and reliable demand is defined as the rate of use of harvested water under average wet season conditions (November through March), from sources meeting the following criteria:
 - The use is permitted by building codes and health codes without requiring disinfection and fine filtration.
 - The use is reliable on a seasonal basis, such that the lowest weekly demand on an average annual basis is no less than 2/7th of the wet season average. *Intent: Under worst-case conditions, the demand should still be sufficient to use the entire tank volume within a week.*
 - Where a reliable use is present on the site that is not permitted by building codes and/or health codes, a variance has been sought to allow use without disinfection and fine filtration.
 - The use does not conflict with mandatory use of reclaimed water. It is assumed that uses do not conflict unless water balance calculations are provided to demonstrate the contrary.
 - The estimated use rates are consistent with requirements for low water use landscaping requirements under local and statewide ordinance.

Criteria for Maximizing Biofiltration Volume

Biofiltration BMPs can be used downstream of a retention BMP that has been “maximized” (e.g., a planter box treating overflow from a cistern) or can be designed to provide both “maximized” retention and “maximized” biotreatment in the same BMP (e.g., a bioretention area with underdrains, where retention volume is provided in a gravel layer below the underdrains).

Volume can be considered to be maximized in biofiltration BMPs when all of the following conditions are met, or when adjustments to the site design and BMP plan to meet any one of these criteria results in achievement of the $\leq 5\%$ EIA performance standard:

- 1) Drain time and/or treatment rate of biofiltration BMPs is consistent with design guidance contained in [Section 6](#) of the 2010 TGM.
- 2) Good site practices have been integrated to provide the maximum area feasible for biofiltration BMPs, and BMPs have been configured to make use of this area. Table 3-1 provides recommended percentages of a site that are feasible to be dedicated to biofiltration BMPs by project type. If the project has not provided these portions of the project site for siting biofiltration BMPs, an attempt should

be made to improve site design to provide more area until it is either infeasible to provide more area or EIA is reduced to $\leq 5\%$.

If a biofiltration BMP also includes a retention component (i.e., storage volume in a swale in amended soil below the surface discharge elevation or storage in a gravel layer below the underdrain of a bioretention area), the maximized retention volume is determined as the volume of water that can be infiltrated or evapotranspired within 48 hours after the biofiltration BMP has emptied. This criterion should be used to establish the depth of the retention layer (i.e., the depth of amended soil below the swale or the thickness of the gravel layer below underdrains in the bioretention area).

3.3 Identification of Pollutants of Concern

The CWA requires that states adopt water quality standards for receiving water bodies and to have those standards approved by the USEPA. Water quality standards consist of designated beneficial uses for a particular receiving water body (e.g. wildlife habitat, agricultural supply, fishing etc.), along with water quality criteria necessary to support those uses. Water quality criteria are prescribed concentrations or levels of constituents, such as lead, suspended sediment, and fecal coliform bacteria limits, or narrative statements which represent the quality of water that support a particular use. Because California had not established a complete list of acceptable water quality criteria, USEPA established numeric water quality criteria for certain toxic constituents in receiving waters with human health or aquatic life designated uses in the form of the California Toxics Rule (“CTR”) (40 CFR 131.38).

Pollutants of concern are defined in [Order R4-2010-0108](#) as constituents that have exceeded the water quality objectives and criteria contained in the Los Angeles Basin Plan or the California Toxics Rule in receiving water monitoring conducted by the permittees. When designated beneficial uses of a particular receiving water body are being compromised by water quality, CWA Section 303(d) requires identifying and listing a water body as “impaired”. Once a water body has been deemed impaired, a Total Maximum Daily Load (TMDL) must be developed for the impairing pollutant(s). A TMDL is an estimate of the total load of pollutants from point, non-point, and natural sources that a water body can assimilate without exceeding applicable water quality standards (with a “factor of safety” included). Once established, the TMDL allocates the loads among current and future pollutant sources to the water body.

The pollutants of concern for a given project site depend on: 1) the project location, 2) the land use and activities that have occurred on the project site in the past or are likely to occur in the future, and 3) the receiving water impairments.

Based on the above, three groups of pollutants of concern can be identified for a project:

- 1) Legacy: Many receiving water impairments are due to legacy pollutants from past land use activities (e.g., DDT from historical farming or PCBs from historical industrial activities), where the primary sources are contaminated soils and sediment. For these pollutants, site clean-up, erosion and sediment controls during construction, slope stabilization measures, and placement of pervious or impervious soil stabilizing surfaces may address the legacy pollutants.
- 2) Moderate Priority: Planned land uses are expected sources of a pollutant, but the receiving water bodies are not impaired by that pollutant.
- 3) High Priority: Planned land uses are expected sources of a pollutant and the receiving water bodies are impaired by that pollutant.

Identifying the pollutant priority group will assist in selecting and designing appropriate BMPs for the pollutants of concern for the project.

Land Use Types/Sources

Pollutants are typically related to land use activities, which means that the proposed site uses provide some indication of the pollutants that will be generated in the site runoff. Table 3-2 identifies pollutants of concern based on typical land use activities that may be present on a project site.

Table 3-2: Common Post-Development Sources of Stormwater Pollutants

Pollutant	Potential Land Use and Activities Sources
Sediment (TSS and Turbidity), Trash and Debris (Gross Solids and Floatables)	Streets, landscaped areas, driveways, roads, construction activities, atmospheric deposition, soil erosion (channels and slopes)
Pesticides and Herbicides	Residential lawns and gardens, roadsides, utility right-of-ways, commercial and industrial landscaped areas, soil wash-off
Organic Materials/Oxygen Demanding Substances	Residential lawns and gardens, commercial landscaping, animal wastes
Metals	Automobiles, bridges, atmospheric deposition, industrial areas, soil erosion, metal surfaces, combustion processes
Oil and Grease/Organics Associated with Petroleum	Roads, driveways, parking lots, vehicle maintenance areas, gas stations, illicit dumping to storm drains, automobile emissions, and fats, oils and grease from restaurants
Bacteria and Viruses	Lawns, roads, leaky sanitary sewer lines, sanitary sewer cross-connections, animal waste (domestic and wild), septic systems, homeless encampments, sediments/biofilms in stormwater conveyance system
Nitrogen and Phosphorus	Landscape fertilizers, atmospheric deposition, automobile exhaust, soil erosion, animal waste, detergents

Adapted from US EPA, 1999 (Preliminary Data Summary of Urban Stormwater BMPs)

Receiving Water Impairments and TMDLs

The most recent 303(d) list for Ventura County watersheds is located on the [State Water Resources Control Board](#) website (click on water issues/programs/water quality assessment).

Uncertainty Associated with Identification of Pollutants of Concern

There is some inherent uncertainty in the identification of pollutants of concern for a project. Pollutants expected in runoff from various land uses and activities are generally based on small, highly variable land use-based monitoring data sets and/or an evaluation of the products and materials used a given activity. Furthermore, in many cases, runoff concentrations in land use-based monitoring data have not been shown to be statistically different from each other. Also, as land use activities and site design practices evolve, particularly with increased incorporation of Retention BMPs, characteristic runoff concentrations and pollutants of concern from various land use types are also likely to change. Finally, the determination of impaired water bodies and the impairment causes also have a degree of uncertainty due to limited data sets used for assessment of impairments. Despite the uncertainties associated with the identification of pollutants of concern, it is a fundamental and necessary step in the BMP selection process.

3.4 Treatment Control Measure Selection Guidance

Treatment Control Measure Selection Criteria

Treatment Control Measure selection criteria contained in [Order R4-2010-0108](#) include the following:

- Treatment Control Measures shall be selected based on the primary class of pollutants likely to be discharged from the project (e.g. metals from an auto repair shop).
- For projects that discharge to an impaired waterbody and whose discharges contain the pollutant causing impairment, the project shall select Treatment Control Measures from the top three performing BMP categories, or alternative BMPs that are designed to meet or exceed the performance of the highest performing BMP, for the pollutant causing impairment.

When considering influent concentrations and statistical significance between data sets, the data contained in the [ASCE International BMP Database](#) indicate that wet detention basins, constructed wetlands, sand filters, and biofilters are among the best performing BMPs for the listed pollutants. This conclusion is consistent with the treatment processes typically provided by these BMP types (e.g., filtration, sedimentation, adsorption, and biological processes).

Wet detention basins and constructed wetlands are attractive solutions both from a treatment process and observed performance perspective. However, these systems require significant base flow to maintain their permanent pools and to avoid creating stagnant conditions and vector concerns. Therefore, these BMPs are often infeasible in locations where water conservation during dry weather is a significant concern. If a regional Treatment Control Measure is desired, infiltration basins and dry extended detention basins may be more feasible in Ventura County. However, these may need additional treatment system components in a treatment train (e.g., pre- or post-treatment) to adequately address the entire list of pollutants of concern and provide reliable and consistent performance, in addition to significant space requirements. BMP designs for each category that incorporate dense vegetation and promote extended contact with or filtration through soils are encouraged, consistent with the BMP selection prioritization requirements in [Order R4-2010-0108](#).

After the appropriate and necessary BMP components are selected for a site, candidate BMP treatment systems can be conceptualized using a treatment train-based approach:

- 1) Minimize runoff flow rates and/or volume from the project site (hydrologic source control);
- 2) Remove bulk solids (pretreatment: > 5mm);
- 3) Remove settleable solids and liquid floatables (coarse primary conventional treatment: >75 μm ; fine primary conventional treatment: >10 μm);
- 4) Remove suspended and colloidal solids (secondary conventional treatment: > 0.1-25 μm); and
- 5) Remove colloidal, dissolved, volatile, and pathogenic pollutants (enhanced treatment).

Additional Treatment Control Measure selection guidance is provided in Appendix D.

Consideration of Site-Specific Conditions

Ultimately, Retention BMPs, Biofiltration BMPs, and Treatment Control Measures have to be constructed at a physical location and site-specific conditions should be considered during the BMP selection process. Site constraints such as steep slopes, poor draining soils, high ground water tables, unstable or contaminated soils and several other factors can preclude the implementation of certain kinds of Retention BMPs, Biofiltration BMPs, and Treatment Control Measures or design options. Therefore, site-specific conditions must be considered when selecting specific BMPs or Treatment Control Measures to implement. Once candidate BMPs or Treatment Control Measures have been chosen, the selection process should consider the site assessment results for soil characteristics, slopes, groundwater proximity, etc. Table

3-3 below provides general guidance for designers regarding site limitations for the different Retention BMPs, Biofiltration BMPs, and Treatment Control Measures.

Table 3-4 below provides general guidance for designers regarding capital and operation costs for the different Retention BMPs, Biofiltration BMPs, and Treatment Control Measures.

Table 3-3: BMP Site Suitability Considerations

Important Note to Users: This table should be used to provide general BMP comparisons only and should not replace an evaluation performed by a qualified water quality professional.

BMP	Site Suitability Considerations			
	Tributary Area (Acres) ¹	Site Slope (%)	Depth to Seasonally High or Mounded Groundwater (ft)	Soil Number
Infiltration BMPs: INF-1: Infiltration Basin INF-2: Infiltration Trench INF-3: Bioretention INF-4: Drywell INF-6: Proprietary Infiltration	< 5	< 7 ²	> 5	Not suitable in Soil Numbers 1, 2, and 3.
INF-5: Permeable Pavement	< 5	< 5 ^{2,5}	> 2 with underdrains; > 5 without underdrains	Underdrains should be provided for Soil Numbers 1, 2, and 3
ET-1: Green Roof	Equal to roof tributary area	N/A	N/A	N/A
BIO-1: Bioretention with Underdrain	< 5	< 15; planter boxes are generally more suitable for steep slopes ^{2,3}	> 2 with underdrains; > 5 without underdrains	Underdrains should be provided for Soil Numbers 1, 2, and 3
BIO-2: Planter Box	< 1	< 15 ⁴	> 2	Any
BIO-3: Vegetated Swale	< 5	< 10 site slope; 0.5 to 6 longitudinal slope of swale ^{2,3}	> 2 with underdrains; > 5 without underdrains	Any ³

BMP	Site Suitability Considerations			
	Tributary Area (Acres) ¹	Site Slope (%)	Depth to Seasonally High or Mounded Groundwater (ft)	Soil Number
BIO-4: Vegetated Filter Strip	< 2	< 4 site slope; 2 to 6 longitudinal slope of strip ²	> 2	Any
BIO-5: Proprietary Biotreatment Devices	The site suitability requirements for specific proprietary devices must be provided by the manufacturer and should be verified by independent sources or assessed by a qualified water quality professional.			
TCM-4: Sand Filter	< 10	< 15 ⁴	> 2	Any
TCM-5: Cartridge Media Filters	The site suitability requirements for specific proprietary devices must be provided by the manufacturer and should be verified by independent sources or assessed by a qualified water quality professional.			
PT-1: Hydrodynamic Devices	The site suitability requirements for specific proprietary devices must be provided by the manufacturer and should be verified by independent sources or assessed by a qualified water quality professional.			
PT-2: Catch Basin Inserts				

¹ Tributary area is the area of the site draining to the BMP. Tributary areas provided here should be used as a general guideline only. Tributary areas can be larger or smaller as appropriate.

² If site slope exceeds that specified or if the system is within 200 ft from the top of a hazardous slope or landslide area (on the uphill side), a geotechnical investigation analysis and report addressing slope stability shall be prepared by a licensed civil engineer. In addition, for swales, if the longitudinal slope exceeds 6%, check dams should be provided.

³ If system is located within 50 feet of a sensitive steep slope (on the uphill side), within 10 feet from a structure, has a longitudinal slope less than 1.5% (swales), or has poorly drained soils (e.g., silts and clays), underdrains should be incorporated.

⁴ If system is fully contained, includes an underdrain system, and overflows to a stormwater conveyance system, then slopes can exceed 15%.

⁵ If a gravel base is used for storage of runoff: (1) slopes should be restricted to 0.5% (steeper grades reduce storage capacity) and (2) underdrains should be used if within 50 feet of a sensitive steep slope.

⁶ Setbacks apply to systems without underdrains.

Table 3-4: BMP Cost Considerations

BMP Type	Relative Expense ⁴ (cost/ac-ft ¹ or cost/cfs ²)	Construction Costs (per cubic feet) ^{3,4}	Typical Cost ³		Annual Maintenance Cost (% of Construction) ^{3,4}	Notes
			(\$/BMP)	Application		
Infiltration Trench	Not included	\$4- \$50	\$45,000	5-ac Commercial Site (65% Impervious)	5%-20%	
Infiltration Basin	\$	\$1.30 - \$18	\$15,000	5-ac Commercial Site (65% Impervious)	1% -10%	
Bioretention	Not included	\$3- \$5.30	\$60,000	5-ac Commercial Site (65% Impervious)	5%- 7%	Cost of plants varies. Maintenance costs comparable to cost of typical landscaping.
Swale	\$\$	\$0.25-\$0.50	\$3,500	5-ac Residential Site (35% Impervious)	5%- 7%	
Filter Strip	\$\$	\$0.00- \$1.30	\$0- \$9,000	5-ac Residential Site (35% Impervious)	\$350/ acre/ year (about \$0.01/square foot/ year)	
Extended Detention Basin	\$\$\$	\$0.50- \$1.00	Not included		3 to 6%	Costs vary widely. One 0.3 ac-ft basin was recorded to have cost \$160,000 ⁵ \$3,132 Annual maintenance costs for per Caltrans ⁵
Wet Ponds	\$\$\$	\$0.50- \$1.00	Not included		3 to 6%	\$17,000 Annual maintenance costs for one Caltrans pond ⁵
Constructed Wetland	\$\$\$\$	\$0.60 – \$1.25	\$125,000	50-Acre Residential Site (35% Impervious)	2%	
Sand Filter	\$\$\$\$	\$3 - \$6	\$35,000- \$70,000	5-Acre Commercial Site (65% Impervious)		

¹ Volume based BMPs

² Flow based BMPs

³ EPA, 1999. Preliminary Data Summary of Urban Storm Water Best Management Practices. Part D, Cost and Benefits Analysis. <http://water.epa.gov/scitech/wastetech/guide/stormwater/index.cfm#report>

⁴ CASQA, 2005. New Development and Redevelopment Handbook

⁵ Figures from Caltrans studies cited in CASQA BMP Handbook.


4 SITE DESIGN PRINCIPLES AND TECHNIQUES

4.1 Introduction

The primary objective of the Site Design Principles and Techniques is to reduce the hydrologic and water quality impacts associated with land development. The benefits derived from this approach include:

- Reduced size of downstream Treatment Control Measures and conveyance systems;
- Reduced pollutant loading to onsite Treatment Control Measures and receiving streams; and
- Reduced hydraulic impact on receiving streams.

Site Design Principles and Techniques include the following design features and considerations:

- Site planning ;
- Protect and restore natural areas;
- Minimize land disturbance;
- Minimize impervious cover;
- Apply Low Impact Development best management practices (LID BMPs) at various scales: and
- Implement Integrated Water Resource Management Practices. 

The Site Design Principles and Techniques described in this section **are required** for all new development and redevelopment projects subject to conditioning and approval for the design and implementation of post-construction stormwater management control measures (as defined in Section 1.5). They are not required if the project proponent demonstrates to the satisfaction of the City or County that the particular measures are not applicable to the proposed project, or the project site conditions make it infeasible to implement the site design control measure in question. The applicability of specific controls outlined within this section should be confirmed with the local government.

Detailed descriptions and design criteria for each of the Site Design Principles and Techniques are presented in the following section.

4.2 Site Planning

Purpose

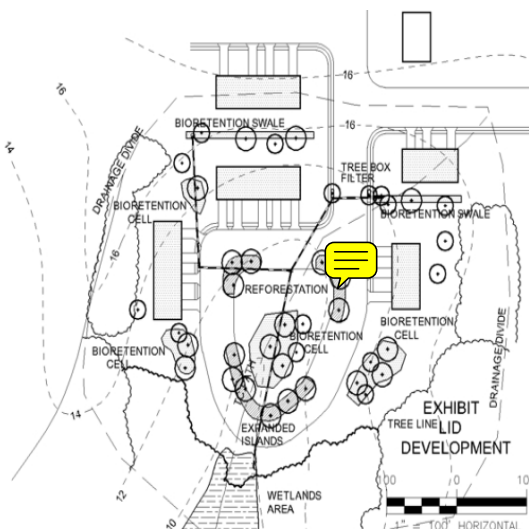
LID requires a holistic approach to site design and stormwater management. As such, planners, developers, architects, and engineers should reconsider conventional approaches to stormwater management. The use of site planning techniques presented here will generate a more hydrologically functional site, help to maximize the effectiveness of Retention BMPs, and integrate stormwater management

throughout the site.

Design Criteria

The following criteria should be considered during the early site planning stages:

- 1) Retention BMPs should be considered as early as possible in the site planning process. Hydrology should be an organizing principle that is integrated into the initial site assessment planning phases.
- 2) Project applicants should anticipate and plan for the space requirements of Retention and Biofiltration BMPs. Table 4-1 provides general rules of thumb for BMP space requirements.
- 3) Site planning should use a multidisciplinary approach that includes planners, engineers, landscape architects, and architects at the initial phases of the project.
- 4) Individual Retention BMPs should be distributed throughout the project site and may influence the configuration of roads, buildings, and other infrastructure.
- 5) Consider flood control early in the design stages. Even sites with Retention BMPs will still have runoff that occurs during large storm events. Look for opportunities to simultaneously address flood control requirements and the requirement to reduce EIA to $\leq 5\%$ presented in Section 2.
- 6) Consider the use of alternative building materials instead of conventional materials for new construction and renovation. Several studies have indicated that metal used as roofing material, flashing, or gutters can leach metals into the environment. Avoid the use of roofing, gutters, and trim made of copper and galvanized (zinc) roofs, gutters, chain link fences and siding.



LID BMPs Integrated within Site Planning Process

Low Impact Development Center, Inc.

Table 4-1: Rule of Thumb Space Requirements for BMPs²

BMP Type	% of Contributing Drainage Area
Infiltration	3 to 10
Rainwater Harvesting (Cistern)	0 to 10
Evapotranspiration (Green Roof)	1 to 1 ratio of impervious cover treated
Biofiltration	3 to 5
Dry Extended Detention Basin	1 to 3
Wet Detention Basin	1 to 3
Sand Filters	0 to 5
Cartridge Media Filter	0 to 5

² Modified from Schueler, T., D. Hirschman, M. Novotney, and J. Zielinski. 2007. Urban Stormwater Retrofit Practices. Manual 3 in the Urban Subwatershed Restoration Manual Series. Center for Watershed Protection, Ellicott City, MD.

4.3 Protect and Restore Natural Areas

Purpose

Each project site possesses unique topographic, hydrologic and vegetative features, some of which are more suitable for development than others. Sensitive areas that should be protected and/or restored include streams and their buffers, floodplains, wetlands, steep slopes, and high permeability soils. Additionally, slopes can be a major source of sediment and should be properly protected and stabilized.

Locating development on the least sensitive portion of a site and conserving naturally vegetated areas can minimize environmental impacts in general and stormwater runoff impacts in particular.





Stream Buffer

Larry Walker Associates

Design Criteria

If applicable and feasible for the given site conditions, the following site design features or elements are required and should be included in the project site layout, consistent with applicable General Plan and Local Area Plan policies:

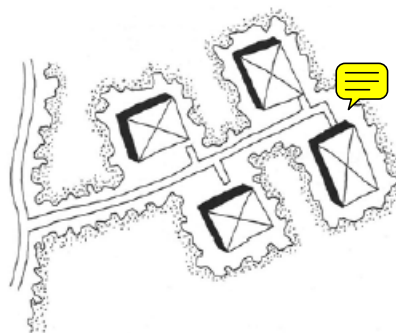
- 1) Identify and cordon off streams and their buffers, floodplains, wetlands, and steep slopes.
- 2) Reserve areas with high permeability soils for either open space or Infiltration BMPs.
- 3) Incorporate existing trees into site layout.
- 4) Identify areas that may be restored or revegetated either during or post-construction.
- 5) Identify and avoid and/or stabilize areas susceptible to erosion and sediment loss.
- 6) Concentrate or cluster development on the least-sensitive portions of a site, while leaving the remaining land in a natural undisturbed state.
- 7) Slopes must be protected from erosion by safely conveying runoff from the tops of slopes.
 - Slopes should be vegetated by first considering use of native or drought-tolerant species.

- Slope protection practices must conform to local permitting agency erosion and sediment control standards and design standards. The design criteria described in this section are intended to enhance and be consistent with these local standards.
- 8)  Limit clearing and grading of native vegetation at the project site to the minimum amount needed to build lots, allow access, and provide fire protection.
 - 9)  Maintain existing topography and existing drainage divides to encourage dispersed flow.
 - 10) Maximize trees and other vegetation at each site by planting additional vegetation, clustering tree areas, and promoting the use of native and/or drought-tolerant plants.
 - 11) Promote natural vegetation by using parking lot islands and other landscaped areas. Integrate vegetated BMPs within parking lot islands and landscaped areas.

4.4 Minimize Land Disturbance

Purpose

This control works to protect water quality by preserving some of the natural hydrologic function of the site. By designing a site layout to preserve the natural hydrology and drainageways on the site, it reduces the need for grading the disturbance of vegetation and soils (GSMM, 2001). By siting buildings and impervious surfaces away from steep slopes, drainageways, and floodplains, it limits the amount of grading, clearing and distance and reduces the hydrologic impact.



Minimized Clearing and Grading

Greenfield et al., 1991

Existing soils may contain organic material and soil biota that are ideal for storing and infiltrating stormwater. Clearing, grading, and heavy equipment can remove and compact existing soils and, therefore, limit their infiltrative capacity. The design criteria presented below are not intended to supersede compaction requirements associated with building codes.

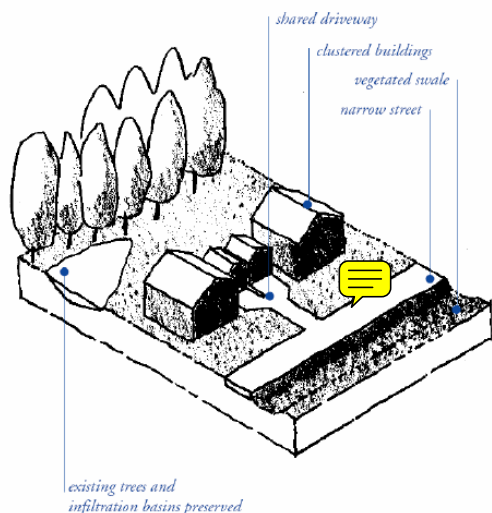
Design Criteria

- 1) Delineate and flag the development envelope for the site. This can be accomplished by identifying the minimum area needed to build lots; allow access and provide fire protection; and protect and buffer sensitive features such as streams, floodplains, steep slopes and wetlands. Concentrate buildings and paved areas on the least permeable soils, with the least intact habitats.
- 2) Plan clearing and grading to minimize the compaction of infiltrative soils.
- 3) Restrict equipment access and storage of construction equipment to the development envelope.
- 4) Restrict storage of construction equipment within the development envelope.
- 5) Avoid the removal of existing trees and valuable vegetation, as feasible.
- 6) Consider soil amendments to restore permeability and organic content especially for infill and redevelopment projects to avoid soil disturbance.

4.5 Minimize Impervious Cover

Purpose

The potential for the discharge of pollutants in stormwater runoff from a project site increases as the percentage of impervious area within the project site increases because impervious areas increase the volume and rate of runoff flow. Pollutants deposited on impervious areas tend to be easily mobilized and transported by surface water runoff. Minimizing impervious area through site design is an important means of minimizing stormwater pollutants of concern. In addition to the environmental and aesthetic benefits, a highly pervious site may allow reduction in the size of downstream conveyance and treatment systems, yielding savings in development costs. Reducing impervious area is the most cost effective way of minimizing the effective impervious area (EIA) requirement.




Impervious Cover Minimization

BASMAA, Start at the Source

Design Criteria

Local permitting agency building and fire codes and ordinances determine some aspects of site design. These design strategies are intended to enhance and be consistent with these local codes and ordinances. Minimizing impervious surfaces at every possible opportunity requires integration of many small strategies. Suggested strategies for minimizing impervious surfaces through site design include the following:

- 1) Use minimum allowable roadway and sidewalk cross sections, driveway lengths, and parking stall widths and lengths.
- 2) Minimize or eliminate the use of curbs and gutters, and maximize the use of Retention BMPs, where slope and density permit.
- 3) Use two-track/ribbon driveways or shared driveways.
- 4) Include landscape islands and cul-de-sac streets.
- 5) Reduce the footprints of building and parking lots.
- 6) Use permeable pavement to accommodate overflow parking (if overflow parking is needed).
- 7) Cluster buildings and paved areas to maximize pervious area.

- 8) Maximize tree preservation or tree planting.
- 9) Avoid compacting or paving over soils with high infiltration rates (see [Minimize Land Disturbance](#)).
- 10) Use [pervious pavement](#) materials where appropriate, such as modular paving blocks, turf blocks, porous concrete and asphalt, brick, and gravel or cobbles.
- 11) Use grass-lined channels or surface swales to convey runoff instead of paved gutters (see [Vegetated Swale in Section 6](#)). 

4.6 Apply LID at Various Scales




Purpose

LID is a decentralized approach to stormwater management that works to mimic the natural hydrology of the site by retaining rainfall onsite. In order to realize the full benefits of water quality protection and runoff volume reduction, LID should be integrated and considered at the regional and watershed scale and the site scale.

Design Criteria


Regional/Watershed



- 1) Consider Density: **Low density development is not always the most protective of water resources.** Higher density development uses less land and produces less impervious cover per capita than low density development (USEPA, 2006). Developments should consider higher densities, but  should still adhere to density levels as specified within local zoning requirements.
- 2) Identify and Preserve Contiguous Open Space: Large contiguous areas of open space can act as a flood control, have an ecological benefit, serve as a buffer for streams and rivers, and provide recreational opportunities (EPA, 2004). Applicants should look for opportunities to link open space preservation with regional open space preservation efforts (such as [Save Open Space and Agricultural Resources](#)).
- 3) Make use of Previously Developed Sites: Redevelopment of existing sites replace impervious cover with impervious cover, reduces  need for greenfield development, and makes use of existing infrastructure.
- 4) Locate Development within Close Proximity to Mass Transit: This maximizes transportation choices, reduces the number of auto  mile trips, and lessens the water quality impacts associated with transportation.

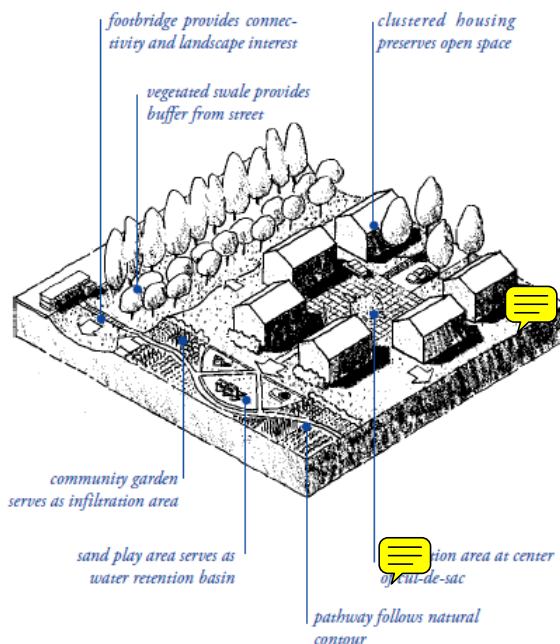
Site

The following design criteria should be considered at the site level in addition to the principles and techniques discussed earlier in this section (e.g., [Minimize Impervious Cover](#)).

- 1) Maintain and Restore Natural Flowpaths for Runoff:  Site buildings and impervious surfaces away from steep slopes, drainageways, and floodplains to reduce the amount of necessary clearing and grading and maintain the pre-development hydrology's time of concentration.

2) Maximize Use of Existing Impervious Cover: Assess and take advantage of opportunities to use existing impervious surfaces at the site level to reduce runoff at a watershed scale.

3) Design Public Spaces and Common Areas to Minimize Stormwater Runoff: Public spaces and common areas can serve as community gathering places but are often composed of impervious cover (e.g., courtyards primarily made up of concrete) (EPA, 2004). Design public spaces and common areas to accommodate both people and stormwater management.



LID BMPs Considered at Various Scales

BASMAA, Start at the Source

4) Compact Project Design: Compact project design reduces the amount of impervious cover per capita, increases walkability, and decreases water quality impacts associated with transportation. Concentrating development on one portion of the site reduces the amount of lawn, provides more opportunities to preserve open space, and maintains and restores natural flow paths. Additionally, compact design can reduce street and driveway length and as a result, can help to reduce the imperviousness associated with development.

5) Encourage Use of Multiple Modes of Transportation: In addition to density and compact design, additional aspects of site design may encourage the use of multiple modes of transportation:

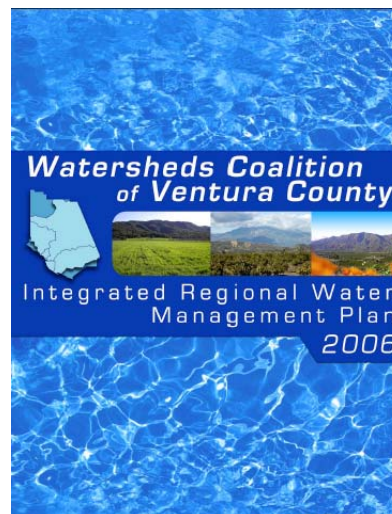
- Bike lanes;
- Well connected sidewalks and streets; and
- Mixed uses

4.7 Implement Integrated Water Resource Management Practices

Purpose

Integrated Water Resource Management (IWRM) is a process which promotes the coordinated development and management of water, land, and related resources. [Order R4-2010-0108](#) promotes the use of IWRM to help guide the selection of BMPs that conserve water, recharge groundwater, provide recreational opportunities and serve as multiple purpose parks and preserve open space.

Many of the concepts of IWRM are documented in the County's Integrated Regional Water Management Plan (IRWMP). The IRWMP is the product of an intensive stakeholder process and addresses multiple water resource management goals including improved water supply reliability, water recycling, water conservation, recreation and access, flood control, wetlands enhancement and creation, and environmental and habitat protection (Watershed Coalition of Ventura County, 2006).



**Integrated Regional Water
Management Plan**
Ventura County

Design Criteria

The [goals of the 2010 TGM](#) and the new development and redevelopment requirements contained within [Order R4-2010-0108](#), complement the goals of the IRWMP. Development projects should strive to select BMPs that meet the following multiple objectives (Watershed Coalition of Ventura County, 2006):

- 1) Conserve and Augment Water Supplies: Identify and evaluate the opportunities to recharge groundwater and increase water use efficiency. This can be accomplished through infiltration of stormwater runoff and selection of drought-tolerant landscaping.
- 2) Protect People, Property and the Environment from Adverse Flooding Impacts: Identify opportunities to utilize BMPs that provide both water quality and water quantity benefits. Provide and maintain setbacks from streams and rivers.
- 3) Protect and Restore Habitat and Ecosystems in Watersheds: Implement the practices identified in [Protect and Restore Natural Areas](#) to integrate habitat and stormwater goals. Landscaping selection for stormwater management practices may also further encourage and attract wildlife.
- 4) Provide Water-related Recreational, Public Access and Educational Opportunities: Integrate recreation and stormwater management by creating multi-functional



BMPs and designing courtyards and open spaces that accommodate both people and stormwater runoff. Consider providing educational signs for BMPs located in public spaces, where appropriate.

5 SOURCE CONTROL MEASURES

5.1 Introduction

Source Control Measures are low-technology practices designed to prevent pollutants from contacting stormwater runoff and prevent discharge of contaminated runoff to the storm drainage system. This section addresses site-specific, structural-type Source Control Measures consisting of specific design features or elements. Non-structural type Source Control Measures; such as good housekeeping and employee training, are not included in the 2010 TGM. The project applicant can consult the California Industrial Best Management Practice Manual for this type of practice (SWQTF, 1993). The governing stormwater agency may require additional Source Control Measures not included in the 2010 TGM for specific pollutants, activities, or land uses.

This section describes control measures for specific types of sites or activities that have been identified as potential significant sources of pollutants in stormwater. Each of the measures specified in this section should be implemented in conjunction with appropriate non-structural Source Control Measures to optimize pollution prevention.

The measures addressed in this section apply to both stormwater and non-stormwater discharges. Non-stormwater discharges are the discharge of any substance, such as process wastewater, to the storm drainage system or water body that is not composed entirely of stormwater. Stormwater that is mixed or commingled with other non-stormwater flows is considered non-stormwater. Discharges of stormwater and non-stormwater to the storm drainage system or a water body may be subject to local, state, or federal permitting prior to discharge. The appropriate agency should be contacted prior to any discharge. Discuss the matter with the stormwater staff if you are uncertain as to which agency should be contacted.

Some of the measures presented in this section require connection to the sanitary sewer system. It is prohibited to connect and discharge to the sanitary sewer system without prior approval or obtaining the required permits. Contact the stormwater staff of the governing agency about obtaining sanitary sewer permits within Ventura County. Discharges of certain types of flows to the sanitary sewer system may be cost prohibitive. The designer is urged to contact the appropriate agency prior to completing site and equipment design of the facility.

5.2 Description

Table 5-1 summarizes site-specific Source Control Measures and associated design features specified for various sites and activities. Fact Sheets are presented in this section for each source control measure. These sheets include design criteria

established by the Approval Agencies to ensure effective implementation of the required Source Control Measures:

Table 5-1: Summary of Site-Specific Source Control Measure Design Features

Site-Specific Source Control Measure ¹	DESIGN FEATURE OR ELEMENT						
	Signs, placards, stencils	Surfacing (compatible, impervious)	Covers, screens	Grading/berming to prevent run-on	Grading/berming to provide secondary containment	Sanitary sewer connection	Emergency Storm Drain Seal
Storm Drain Message and Signage (S-1)	X						
Outdoor Material Storage Area Design (S-2)		X	X	X	X		X
Outdoor Trash Storage and Waste Handling Area Design (S-3)		X	X	X		X	
Outdoor Loading/Unloading Dock Area Design (S-4)		X	X	X	X		
Outdoor Repair/Maintenance Bay Design (S-5)		X	X	X	X		X
Outdoor Vehicle/Equipment/Accessory Washing Area Design (S-6)		X	X	X	X	X	X
Fueling Area Design (S-7)		X	X	X	X		X
Parking Lot Design ²							

1 Refer to Fact Sheets in Section 6 for detailed information and design criteria and Appendix E for BMP sizing worksheets

2 Requirements for proper design of parking lots are covered by requirements for General Site Design Principles and Techniques (see Section 4) and Treatment Control Measures (see Section 6).

5.3 Site-Specific Source Control Measures

S-1: Storm Drain Message and Signage

Purpose

Waste materials dumped into storm drain inlets can have severe impacts on receiving and ground waters. Posting notices regarding discharge prohibitions at storm drain inlets can prevent waste dumping. This Fact Sheet contains details on the installation of storm drain messages at storm drain inlets located in new or redeveloped commercial, industrial, and residential sites.

Design Criteria

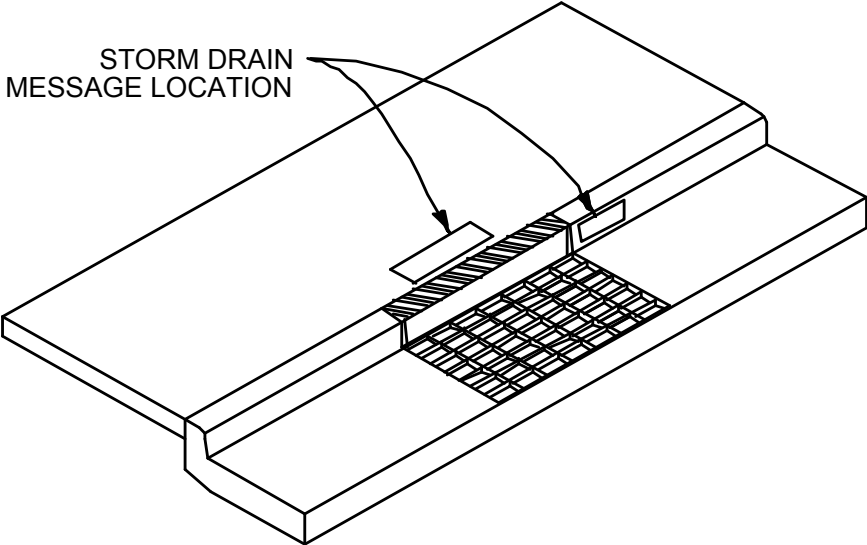
Storm drain messages have become a popular method of alerting the public to the effects of and the prohibitions against waste disposal into the storm drain system. The signs are typically stenciled or affixed near the storm drain inlet. The message simply informs the public that dumping of wastes into storm drain inlets is prohibited and/or the drain discharges to a receiving water.

Storm drain message markers or placards are required at all storm drain inlets within the boundary of the development project. The marker should be placed in clear sight facing anyone approaching the inlet from either side (see Figure 5-1). All storm drain inlet locations must be identified on the development site map.

Some local agencies within the County have approved storm drain message placards for use. Signs with language and/or graphical icons, which prohibit illegal dumping, shall be posted at designated public access points along channels and streams within a project area. Consult local permitting agency stormwater staff to determine specific requirements for placard types and installation methods.

Maintenance Requirements

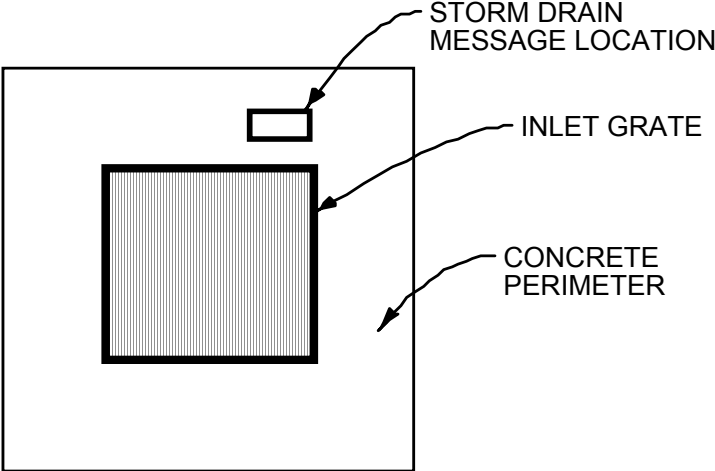
Legibility of markers and signs shall be maintained. If required by the agency with jurisdiction over the project, the owner/operator or homeowner's association shall enter into a Maintenance Agreement with the agency or record a deed restriction upon the property title to maintain the legibility of placards and signs.



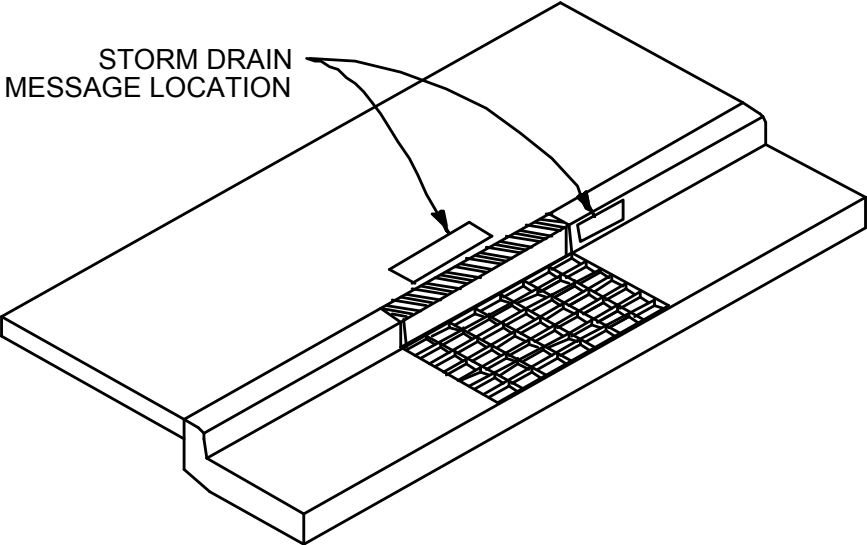
CURB TYPE INLET

NOTES:

- 1. STORM DRAIN MESSAGE SHALL BE APPLIED IN SUCH A WAY AS TO PROVIDE A CLEAR, LEGIBLE IMAGE.
- 2. STORM DRAIN MESSAGE SHALL BE PERMANENTLY APPLIED DURING THE CONSTRUCTION OF THE CURB AND GUTTER USING A METHOD APPROVED BY THE LOCAL AGENCY.



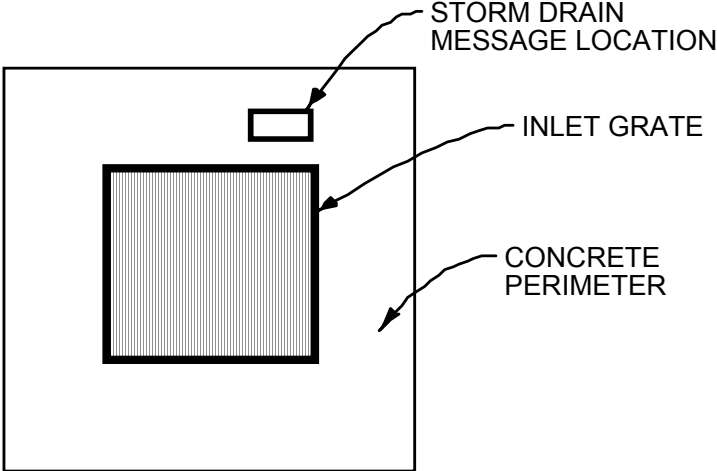
AREA TYPE INLET



CURB TYPE INLET

NOTES:

- 1. STORM DRAIN MESSAGE SHALL BE APPLIED IN SUCH A WAY AS TO PROVIDE A CLEAR, LEGIBLE IMAGE.
- 2. STORM DRAIN MESSAGE SHALL BE PERMANENTLY APPLIED DURING THE CONSTRUCTION OF THE CURB AND GUTTER USING A METHOD APPROVED BY THE LOCAL AGENCY.



AREA TYPE INLET

Figure 5-1: Storm Drain Message Location

S-2: Outdoor Material Storage Area Design

Purpose

Materials that are stored outdoors could become sources of pollutants in stormwater runoff if not handled or stored properly. Materials could be in the form of raw products, by-products, finished products, and waste products. The type of pollutants associated with the materials will vary depending on the type of commercial or industrial activity.

Some materials are more of a concern than others. Toxic and hazardous materials must be prevented from coming in contact with stormwater. Non-toxic or non-hazardous materials do not have to be prevented from stormwater contact, but cannot be allowed to runoff with the stormwater. These materials may have toxic effects on receiving waters. Accumulated material on an impervious surface could result in significant debris and sediment being discharged with stormwater runoff causing a significant impact on the rivers or streams that receive the runoff.

Materials may be stored in a variety of ways, including bulk piles, containers, shelving, stacking, and tanks. Stormwater contamination may be prevented by eliminating the possibility of stormwater contact with the material storage areas either through diversion, cover, or capture of the stormwater. Control measures may also include minimizing the storage area. Control measures are site-specific and must meet local permitting agency requirements.

Design Criteria

Design requirements for material storage areas are governed by Building and Fire Codes and by current City or County ordinances and zoning requirements. Source Control Measures described in the Fact Sheet are intended to enhance and be consistent with these code and ordinance requirements. The following design features should be incorporated into the design of a material storage area when storing materials outside could contribute significant pollutants to the storm drain.

Table 5-2: Design Criteria for Outdoor Material Storage Area Design

Source Control Design Feature	Design Criteria
Surfacing	<ul style="list-style-type: none"> • Construct the storage area base with a material impervious to leaks and spills.
Covers	<ul style="list-style-type: none"> • Install a cover that extends beyond the storage area, or use a manufactured storage shed for small containers.
Grading/Containment	<ul style="list-style-type: none"> • Minimize the storage area. • Slope the storage area towards a dead-end sump to contain spills. • Grade or berm storage areas to prevent run-on from surrounding areas. • Direct runoff from downspouts/roofs away from storage areas.

Accumulated Stormwater and Non-stormwater

Stormwater and non-stormwater will accumulate in containment areas and sumps with impervious surfaces. Contaminated accumulated water must be disposed of in accordance with applicable laws and cannot be discharged directly to the storm drain or sanitary sewer system without the appropriate permit.

S-3: Outdoor Trash Storage Area Design

Purpose

Stormwater runoff from areas where trash is stored or disposed of can be polluted. In addition, loose trash and debris can be easily transported by water or wind into nearby storm drain inlets, channels, and/or creeks. Waste handling operations may be sources of stormwater pollution and include dumpsters, litter control, and waste piles. This fact sheet contains details on the specific measures required to prevent or reduce pollutants in stormwater runoff associated with trash storage and handling.

Design Criteria

Design requirements for waste handling areas are governed by Building and Fire Codes, and by current local permitting agency ordinances and zoning requirements. The design criteria described in the Fact Sheet are meant to enhance and be consistent with these code and ordinance requirements. Hazardous waste should be handled in accordance with legal requirements established in Title 22, California Code of Regulations.

Wastes from commercial and industrial sites are typically hauled by either public or commercial carriers that may have design or access requirements for waste storage areas. The design criteria listed below are recommendations and are not intended to be in conflict with requirements established by the waste hauler. The waste hauler

should be contacted prior to the design of your site trash collection area to obtain established and accepted guidelines for designing trash collection areas. Conflicts or issues should be discussed with the local permitting agency.

The following trash storage area design controls were developed to enhance the local permitting agency codes and ordinances and should be implemented depending on the type of waste and the type of containment.

Table 5-3: Design Criteria for Outdoor Trash Storage Areas

Source Control Design Feature	Design Criteria
Surfacing	<ul style="list-style-type: none"> • Construct the storage area base with a material impervious to leaks and spills.
Screens/Covers	<ul style="list-style-type: none"> • Install a screen or wall around trash storage area to prevent offsite transport of loose trash. • Use lined bins or dumpsters to reduce leaking of liquid wastes. • Use water-proof lids on bins/dumpsters or provide a roof to cover enclosure (local permitting agency discretion) to prevent rainfall from entering containers.
Grading/Contouring	<ul style="list-style-type: none"> • Berm or grade the waste handling area to prevent run-on of stormwater. • Do not locate storm drains in immediate vicinity of the trash storage area.
Signs	<ul style="list-style-type: none"> • Post signs on all dumpsters informing users that hazardous materials are not to be disposed of therein.

Maintenance Requirements

The owner/operator must maintain the integrity of structural elements that are subject to damage (e.g. screens, covers and signs). Maintenance Agreements between the local permitting agency and the owner/operator may be required. Some agencies will require maintenance deed restrictions to be recorded of the property title. If required by the local permitting agency, Maintenance Agreements or deed restrictions must be executed by the owner/operator before improvement plans are approved. Refer to Appendix G and H for further guidance regarding Maintenance Plan Agreements.

S-4: Outdoor Loading/Unloading Dock Area Design

Purpose

Materials spilled, leaked, or lost during loading or unloading may collect on impervious surfaces or in the soil and be carried away by runoff or when the area is cleaned. Rainfall may also wash pollutants from machinery used to load or unload materials. Depressed loading docks (truck wells) are contained areas that can accumulate stormwater runoff. Discharge of spills or contaminated stormwater to

the storm drain system is prohibited. This Fact Sheet contains details on specific measures recommended to prevent or reduce pollutants in stormwater runoff from outdoor loading or unloading areas.

Design Criteria

Design requirements for outdoor loading and unloading of materials are governed by Building and Fire Codes, and by current local permitting agency ordinances and zoning requirements. Source Control Measures described in this Fact Sheet are meant to enhance and be consistent with these code and ordinance requirements. Companies may have their own design or access requirements for loading docks. The design criteria listed below are not intended to be in conflict with requirements established by individual companies. Conflicts or issues should be discussed with the local permitting agency.

The following design criteria should be followed when developing construction plans for material loading and unloading areas:

Table 5-4: Design Criteria for Outdoor Loading/ Unloading Areas

Source Control Design Feature	Design Criteria
Surfacing	<ul style="list-style-type: none"> Construct floor surfaces with materials that are compatible with materials being handled in the loading/unloading area.
Covers	<ul style="list-style-type: none"> Cover loading/unloading areas to a distance of at least 3 feet beyond the loading dock or install a seal or door skirt to be used for all material transfers between the trailer and the building.
Grading/Contouring	<ul style="list-style-type: none"> Grade or berm storage the areas to prevent run-on from surrounding areas. Direct runoff from downspouts/roofs away from loading areas.
Emergency Storm Drain Seal	<ul style="list-style-type: none"> Do not locate storm drains in the loading dock area. Direct connections to storm drains from depressed loading docks are prohibited. Provide means, such as isolation valves, drain plugs, or drain covers, to prevent spills or contaminated stormwater from entering the storm drainage system.

Accumulated Stormwater and Non-stormwater

Stormwater and non-stormwater will accumulate in containment areas and sumps with impervious surfaces, such as depressed loading docks. Contaminated accumulated water must be disposed of in accordance with applicable laws and cannot be discharged directly to the storm drain or sanitary sewer system without the appropriate permit.

S-5: Outdoor Repair/Maintenance Bay Design

Purpose

Activities that can contaminate stormwater include engine repair, service, and parking (i.e. leaking engines or parts). Oil and grease, solvents, car battery acid, coolant and gasoline from the repair/maintenance bays can severely impact stormwater if allowed to come into contact with stormwater runoff. This Fact Sheet contains details on the specific measures required to prevent or reduce pollutants in stormwater runoff from vehicle and equipment maintenance and repair areas.

Design Criteria

Design requirements for vehicle maintenance and repair areas are governed by Building and Fire Codes, and by current local permitting agency ordinances, and zoning requirements. The design criteria described in this Fact Sheet are meant to enhance and be consistent with these code requirements.

The following design criteria are required for vehicle and equipment maintenance, and repair. All wash water, hazardous and toxic wastes must be prevented from entering the storm drainage system.

Source Control Design Feature	Design Criteria
Surfacing	<ul style="list-style-type: none"> Construct the vehicle maintenance/repair floor area with Portland cement concrete.
Covers	<ul style="list-style-type: none"> Cover or berm areas where vehicle parts with fluids are stored. Cover or enclose all vehicle maintenance/repair areas.
Grading/ Contouring	<ul style="list-style-type: none"> Berm or grade the maintenance/repair area to prevent run-on and runoff of stormwater or runoff of spills. Direct runoff from downspouts/roofs away from maintenance/repair areas. Grade the maintenance/repair area to drain to a dead-end sump for collection of all wash water, leaks and spills. Direct connection of maintenance/repair area to storm drain system is prohibited. Do not locate storm drains in the immediate vicinity of the maintenance/repair area.
Emergency Storm Drain Seal	<ul style="list-style-type: none"> Provide means, such as isolation valves, drain plugs, or drain covers, to prevent spills or contaminated stormwater from entering the storm drainage system.

Accumulated Stormwater and Non-stormwater

Stormwater and non-stormwater will accumulate in containment areas and sumps with impervious surfaces. Contaminated accumulated water must be disposed of in accordance with applicable laws and cannot be discharged directly to the storm drain or sanitary sewer system without the appropriate permit.

S-6: Outdoor Vehicle/Equipment/Accessory Washing Area Design

Purpose

Washing vehicles and equipment in areas where wash water flows onto the ground can pollute stormwater. Wash waters are not allowed in the storm drain system. They can contain high concentrations of oil and grease, solvents, phosphates and high suspended solids loads. Sources of washing contamination include outside vehicle/equipment cleaning or wash water discharge to the ground. This Fact Sheet contains details on the specific measures required to prevent or reduce pollutants in stormwater runoff from vehicle and equipment washing areas.

Design Criteria

Design requirements for vehicle maintenance and repair areas are governed by Building and Fire Codes, and by current local permitting agency ordinances, and zoning requirements. The design criteria described in this Fact Sheet are meant to enhance and be consistent with these code requirements.

The following design criteria are required for vehicle and equipment washing areas. All hazardous and toxic wastes must be prevented from entering the storm drain system.

Source Control Design Feature	Design Criteria
Surfacing	<ul style="list-style-type: none"> • Construct the vehicle/equipment wash area floors with Portland cement concrete.
Covers	<ul style="list-style-type: none"> • Provide a cover that extends over the entire wash area.
Grading/ Contouring	<ul style="list-style-type: none"> • Berm or grade the maintenance/repair area to prevent run-on and runoff of stormwater or runoff of spills. • Grade or berm the wash area to contain the wash water within the covered area and direct the wash water to treatment and recycle or pretreatment and proper connection to the sanitary sewer system. Obtain approval from the governing agency before discharging to the sanitary sewer. • Direct runoff from downspouts/roofs away from wash areas. • Do not locate storm drains in the immediate vicinity of the wash area.
Emergency Storm Drain Seal	<ul style="list-style-type: none"> • Provide means, such as isolation valves, drain plugs, or drain covers, to prevent spills or contaminated stormwater from entering the storm drainage system.

Accumulated Stormwater and Non-stormwater

Stormwater and non-stormwater will accumulate in containment areas and sumps with impervious surfaces. Contaminated accumulated water must be disposed of in accordance with applicable laws and cannot be discharged directly to the storm drain or sanitary sewer system without the appropriate permit.

S-7: Fueling Area Design

Purpose

Spills at vehicle and equipment fueling areas can be a significant source of pollution because fuels contain toxic materials and heavy metals that are not easily removed by stormwater treatment devices. When stormwater mixes with fuel spilled or leaked onto the ground, it becomes polluted by petroleum-based materials that are harmful to humans, fish, and wildlife. This could occur at large industrial sites or at small commercial sites such as gas stations and convenience stores. This Fact Sheet contains details on specific measures required to prevent or reduce pollutants in stormwater runoff from vehicle and equipment fueling areas, including retail gas stations.

Design Criteria

Design requirements for fueling areas are governed by Building and Fire Codes and by current local permitting agency ordinances and zoning requirements. The design requirements described in this Fact Sheet are meant to enhance and be consistent with these code and ordinance requirements.

Source Control Design Feature	Design Criteria
Surfacing	<ul style="list-style-type: none"> • Fuel dispensing areas must be paved with Portland cement concrete. The fuel dispensing area is defined as extending 6.5 feet from the corner of each fuel dispenser or the length at which the hose and nozzle assemble may be operated plus 1 foot, whichever is less. The paving around the fuel dispensing area may exceed the minimum dimensions of the “fuel dispensing area” stated above. • Use asphalt sealant to protect asphalt paved areas surrounding the fueling area.
Covers	<ul style="list-style-type: none"> • The fuel dispensing area must be covered ¹, and the cover’s minimum dimensions must be equal to or greater than the area within the grade break or the fuel dispensing area, as defined above. The cover must not drain onto the fuel dispensing area.
Grading/ Contouring	<ul style="list-style-type: none"> • The fuel dispensing area shall have a 2% to 4% slope to prevent ponding and must be separated from the rest of the site by a grade break that prevents run-on of stormwater to the extent practicable. • Grade the fueling area to drain toward a dead-end sump. • Direct runoff from downspouts/roofs away from fueling areas. • Do not locate storm drains in the immediate vicinity of the fueling area.

Source Control Design Feature	Design Criteria
Emergency Storm Drain Seal	<ul style="list-style-type: none"> • Provide means, such as isolation valves, drain plugs, or drain covers, to prevent spills or contaminated stormwater from entering the storm drainage system.

1. If fueling large equipment or vehicles that would prohibit the use of covers or roofs, the fueling island should be designed to sufficiently accommodate the larger vehicles and equipment and to prevent run-on and runoff of stormwater. Grade to direct stormwater to a dead-end sump.

Accumulated Stormwater and Non-stormwater

Stormwater and non-stormwater will accumulate in containment areas and sumps with impervious surfaces. Contaminated accumulated water must be disposed of in accordance with applicable laws and cannot be discharged directly to the storm drain or sanitary sewer system without the appropriate permit.

S-8: Proof of Control Measure Maintenance

Purpose

Continued effectiveness of control measures specified in the 2010 TGM depends on diligent ongoing inspection and maintenance. To ensure that such maintenance is provided, the local permitting agency will require both a Maintenance Agreement and a Maintenance Plan from the owner/operator of stormwater control measures.

Maintenance Agreement

Onsite Treatment Control Measures are to be maintained by the owner/operator. Maintenance Agreements between the governing agency and the owner/operator may be required. A Maintenance Agreement with the governing agency must be executed by the owner/operator before occupancy of the project is approved. A sample Maintenance Agreement form is provided in Appendix H.

Maintenance Plan

A post-construction Maintenance Plan shall be prepared and made available at the governing agency’s request. The Maintenance Plan should address items such as:

- Operation plan and schedule, including a site map;
- Maintenance and cleaning activities and schedule;
- Equipment and resource requirements necessary to operate and maintain facility; and
- Responsible party for operation and maintenance.

Additional guidelines for Maintenance Plans are provided in Appendix I.

6 STORMWATER BMP DESIGN

6.1 Introduction

Retention BMPs, Biofiltration BMPs, and Treatment Control Measures are required to augment Site Design Principles and Techniques and Source Control Measures to reduce pollution from stormwater discharges to the maximum extent practicable. Retention BMPs are engineered facilities that are designed to retain surface runoff on the project site. Biofiltration BMPs are vegetated stormwater BMPs that remove pollutants by filtering stormwater through vegetation and soils. Treatment Control Measures are engineered BMPs that provide a reduction of pollutant loads and concentrations in stormwater runoff. The type(s) of Retention BMPs and Biofiltration BMPs to be implemented depends on site suitability factors discussed in this chapter. The type of Treatment Control Measure(s) to be implemented at a site depends on a number of factors including: type of pollutants in the stormwater runoff, quantity of stormwater runoff to be treated, project site conditions, receiving water conditions, and state industrial permit requirements, where applicable. Land requirements and costs to design, construct, and maintain Treatment Control Measures vary by type.

Unlike flood control measures that are designed to handle peak flows, stormwater Retention BMPs, Biofiltration BMPs, and Treatment Control Measures are designed to retain or treat the more frequent, lower-flow storm events, or the first flush runoff from larger storm events (typically referred to as the first flush events). Small, frequent storm events represent most of the total average annual rainfall for the area. It's the volume from such small events, referred to as the Stormwater Quality Design Volume (SQDV), that is targeted for retention onsite in Retention BMPs. Biofiltration BMPs and Treatment Control Measures can be sized to capture either the SQDV or the Stormwater Quality Design Flow (SQDF). Calculation methods for the SQDV and the SQDF are presented in [Section 2](#) and Appendix E.

6.2 General Considerations

Retention BMPs, Biofiltration BMPs, and Treatment Control Measures are designed to remove pollutants contained in stormwater runoff. The pollutants of concern, depending on the watershed, may include trash, debris, and sediment; metals such as copper, lead, and zinc; nutrients such as nitrogen and phosphorous; certain bacteria and viruses; mineral salts such as chloride; and organic chemicals such as petroleum hydrocarbons and pesticides. Pollutant removal methods include sedimentation/settling, filtration, plant uptake, ion exchange, adsorption, and microbially-mediated decomposition. Floatable pollutants such as oil, debris, and scum can be removed with separator structures. Retention BMPs, Biofiltration BMPs, and some Treatment Control Measures are also designed to reduce runoff volume, thereby reducing pollutant loading to receiving waters. Retention BMP,

Biofiltration BMPs, and Treatment Control Measure types and common terms used in stormwater treatment are discussed below.

Maintenance Responsibility

Unless otherwise agreed to by the governing stormwater agency, the landowner, site operator, or homeowner's association is responsible for the operation and maintenance of the Retention BMPs, Biofiltration BMPs, and Treatment Control Measures. Failure to properly operate and maintain the measures could result in reduced treatment of stormwater runoff or a concentrated loading of pollutants to the storm drain system. To protect against failure, a Maintenance Plan must be developed and implemented for all Retention BMPs, Biofiltration BMPs, and Treatment Control Measures. Guidelines for maintenance plans are provided in Appendix I of the 2010 TGM. The Plan must be made available at the agency's request. In addition, a maintenance agreement with the governing agency may be required. The example maintenance agreements are included in Appendix H.

In addition to maintenance, the governing agency may require water quality monitoring agreements for any of the Retention BMPs, Biofiltration BMPs, or Treatment Control Measures recommended in the 2010 TGM. Monitoring may be conducted by the site operator, the agency, or both. Monitoring may be required for a period of time to help the agency evaluate the effectiveness of Retention BMPs, Biofiltration BMPs, and Treatment Control Measures in reducing pollutants in stormwater runoff.

The primary purpose of Biofiltration BMPs and Treatment Control Measures is water quality treatment. However, an ancillary benefit of certain BMPs may be the provision to preserve and/or enhance habitat for aquatic and terrestrial wildlife. The quality and extent of such habitat may be affected by maintenance activities required to ensure the continued water quality performance of the BMP. In situations where there is potential for habitat to attract threatened or endangered species, the project proponent must coordinate with and develop written agreements with the California Department of Fish and Game or the US Fish and Wildlife service. These agreements must ensure that the Biofiltration BMPs and Treatment Control Measures are considered treatment facilities and not Waters of the United States, and that long-term operation and maintenance requirements are acceptable to these agencies.

Pretreatment

Pretreatment must be provided for filtration and infiltration facilities and other facilities whose function could be adversely affected by sediment or other pollutants. Pretreatment may also be provided for water quality detention basins and other Treatment Control Measures to facilitate the routine removal of sediment, trash, and debris, and to increase the longevity of the downstream BMPs.

Pretreatment may be provided by presettling basins or forebays (small detention basins), vegetated swales, filter strips, hydrodynamic separators, and catch basin

inserts. Source control activities, described in Chapter 5, minimize the introduction of pollutants into stormwater runoff and also help to protect filtration and infiltration facilities. Effort should be made early in the site planning stages to minimize runoff from impervious areas by grading toward landscaped areas, disconnecting downspouts, and using pervious conveyances prior to discharging to the storm drain system. These site design practices can reduce the size and maintenance burden of downstream, end-of-pipe BMPs.

Oil/Water Separation

Oil/water separators remove floating oil from the water surface. There are two general types of separators: American Petroleum Institute (API) separators and coalescing plate (CP) separators. Both types use physical mechanisms to remove high concentrations of floating and dispersed oil. Oil/water separators are not suitable for the relatively low concentrations of petroleum hydrocarbons present in typical urban runoff, and should only be used in locations where higher concentrations of oil are expected to occur, such as retail fuel facilities, high volume roads, and petroleum-related industrial facilities. Oil/water separators must be located off-line from the primary conveyance system, as they function at low flow conditions and will wash out in high flow conditions. Other oil control devices/facilities that may be used for pretreatment of slightly elevated concentrations of oil (i.e., typical of high use commercial parking lots) include catch basin inserts, hydrodynamic devices, and linear sand filters. Oil control devices/facilities should always be placed upstream of other treatment facilities and as close to the oil source as possible.

Infiltration

Infiltration refers to the use of the filtration, adsorption, and biological decomposition properties of soils to remove pollutants prior to the intentional routing of runoff to the subsurface for groundwater recharge. Infiltration BMPs are a type of Retention BMP and include [infiltration basins](#), [infiltration trenches](#), [bioretention](#) without an underdrain, [dry wells](#), and [permeable pavement](#). Infiltration can provide multiple benefits including pollutant removal, hydromodification control, groundwater recharge, and flood control. However, conditions that can limit the use of infiltration include soil properties and potential adverse impacts on groundwater quality. A geotechnical investigation must be conducted when evaluating infiltration to determine the suitability of the site soil in adequately addressing groundwater protection. This may include an in-situ percolation test, per the guidance provided in Appendix C, and the determination of minimum depth to groundwater. The minimum separation to seasonal high groundwater or estimated mounded groundwater is five feet. Depth to seasonal high groundwater level shall be estimated as the average of the annual minima (i.e., the shallowest recorded measurements in each water year, defined as October 1 through September 30) for all years on record. If groundwater level data are not available or not considered to be representative, seasonal high groundwater depth can be determined by

redoximorphic analytical methods combined with temporary groundwater monitoring for November 1 through April 1 at the proposed project site.

Soils should have sufficient organic content and sorption capacity to remove certain pollutants, but must be coarse enough to infiltrate runoff in a reasonable amount of time (e.g., < 72 hours for above-ground ponded water to prevent vector breeding). Examples of suitable soils are silty and sandy loams. Coarser soils, such as gravelly sands, have limited organic content and high permeability and therefore present a potential risk to groundwater from certain pollutants, especially in areas of shallow groundwater. Prior to the use of infiltration BMPs, consult with the local permitting agency to identify if vulnerable unconfined aquifers are located beneath the project to determine the appropriateness of these BMPs. In an area identified as an unconfined aquifer, the application of infiltration BMPs should include significant pretreatment to ensure groundwater is protected from pollutants of concern.

Infiltration BMPs should not be placed in high-risk areas such as at or near service/gas stations, truck stops, and heavy industrial sites due to the groundwater contamination risk. Infiltration BMPs may be placed in high-risk areas if a site-specific evaluation demonstrates that sufficient pretreatment is provided to address pollutants of concern, high risks areas are isolated from stormwater runoff, or infiltration areas have little chance of spill migration.

In addition, infiltration BMPs must be sited at least 50 feet away from slopes steeper than 15 percent. Adequate spacing (100 feet or more) must be provided between infiltration BMPs and potable wells, non-potable wells, drain fields, and springs. Infiltration BMPs must be setback from building foundations at least eight feet or have an alternative setback established by the geotechnical expert for the project.

Infiltration is not allowed at locations with contaminated soils or groundwater where the pollutants could be mobilized or exacerbated by infiltration, unless a site-specific analysis determines the infiltration would not be detrimental. A site-specific analysis shall be prepared where pollutant mobilization (e.g., Brownfield development or naturally-derived groundwater pollutants) is a concern. Projects must consider the potential for mobilization of groundwater contamination from natural sources as a result of stormwater infiltration (e.g., marine sediments, selenium-rich groundwater) to the extent that data is available.

Incidental infiltration that occurs in other types of Biofiltration BMPs and Treatment Control Measures, such as dry extended detention basins, vegetation swales, filter strips, and bioretention areas with underdrains, pose little risk to groundwater quality as treatment is provided in the BMP prior to infiltration.

Biofiltration BMPs

Biofiltration BMPs use vegetation and soils or other filtration media for runoff treatment. As runoff passes through the vegetation and filtration media, the combined effects of filtration, adsorption, and biological uptake remove pollutants.

In biofiltration BMPs, pore spaces and organic material in the soils help to retain water in the form of soil moisture and to promote the pollutant adsorption (e.g., dissolved metals and petroleum hydrocarbons) into the soil matrix. Plants use soil moisture, promote the drying of the soil through transpiration, and uptake pollutants in their roots and leaves. Plants with extensive root systems also help to maintain filtration rates. Vegetation also decreases the velocity of flow and allows for particulates to settle.

Treatment Control Measures

Filtration

Various media, such as sand, perlite, zeolite, compost, and activated carbon, can be used in filtration BMPs to effectively remove total suspended solids (TSS) and associated pollutants such as organics (hydrocarbons and pesticides) and particulate metals. Filtration systems can be configured in the form of horizontal beds, trenches, or lastly, cartridge systems in underground vaults or catch basins.

Wetpools

A wetpool is a permanent pool of water incorporated into a wetpond or stormwater wetland BMP. Wetpools provide runoff treatment by allowing settling of particulates (sedimentation) by biological uptake and by vegetative filtration (if vegetation is present). Wetpool BMPs may be single-purpose facilities, providing only runoff treatment, or they may also provide flow control by providing additional detention storage with the use of a multi-stage outlet structure. If combined with detention, the wetpool volume can often be stacked under the detention volume with little further loss of development area.

“On-line” and “Off-line” Facilities

The location and configuration of control facilities can vary depending on the desired function. For example, drop structures or grade control may be located in a drainage channel so as to stabilize a channel for hydromodification control purposes. Such facilities are referred to as “in-stream” controls. Retention BMPs, Biofiltration BMPs, and Treatment Control Measures may not be located in-stream. Retention BMPs, Biofiltration BMPs, and Treatment Control Measures cannot be located in Waters of the US, but rather must be located upland to retain or treat runoff prior to discharge into Waters of the US.

If a Retention BMP, Biofiltration BMP, or Treatment Control Measure facility is designed such that all the runoff passes through the facility, the facility is called an “on-line” system. If, on the other hand, the facility only receives flows less than or equal to the stormwater quality design flow (SQDF), the facility is called an “off-line” system. Off-line systems therefore require a flow splitter or equivalent device. Generally treatment performance is better for off-line facilities because a larger

percentage of the runoff is treated. Figure 6-1 illustrates the difference between on-line, off-line, and in-stream controls.

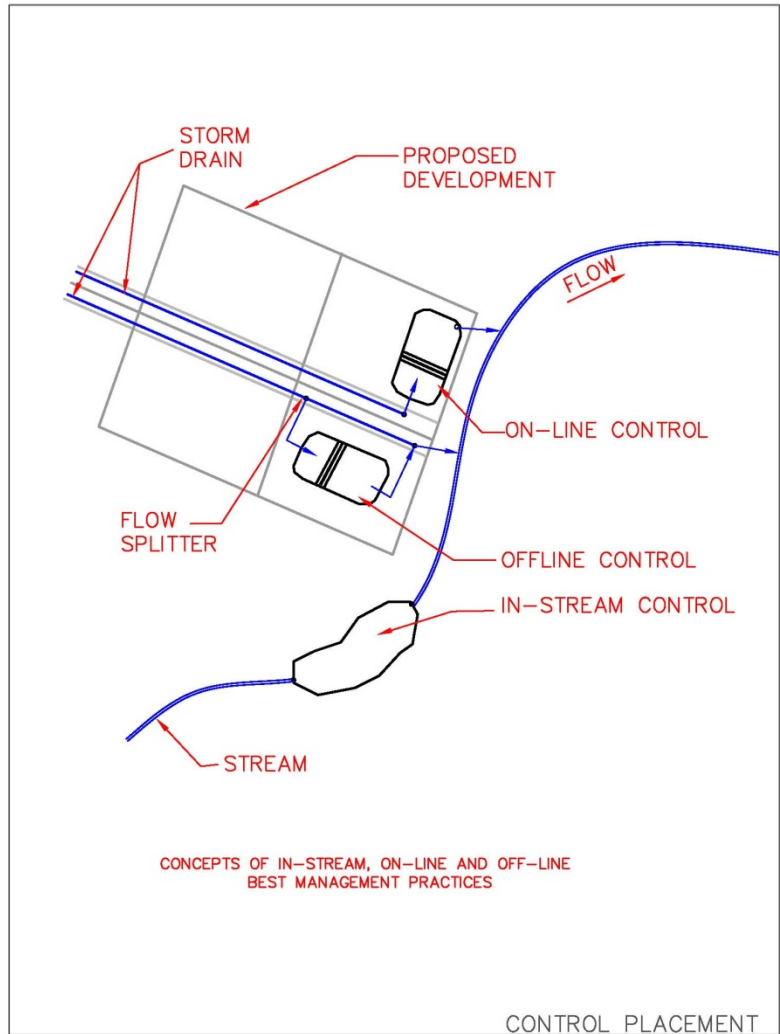


Figure 6-1: Differences between On-line, Off-line, and In-stream Control Measures

6.3 Retention BMP, Biofiltration BMP, and Treatment Control Measure Fact Sheets

This section provides fact sheets for design and implementation of recommended Retention BMPs, Biofiltration BMPs, and Treatment Control Measures. The fact sheets include siting, design, and maintenance requirements to ensure optimal performance of the measures. The 2010 TGM also contains calculation worksheets to aid in the design of these BMPs in Appendix E. New BMPs that are equivalent to

those included in the 2010 TGM are acceptable based on approval of the local permitting agency.

Fact sheets are provided for the Retention BMPs, Biofiltration BMPs, and Treatment Control Measures listed below:

Retention BMPs

Infiltration BMPs

[INF-1: Infiltration Basin](#)

[INF-2: Infiltration Trench](#)

[INF-3: Bioretention](#)

[INF-4: Drywell](#)

[INF-5: Permeable Pavement](#)

[INF-6: Proprietary Infiltration](#)

Rainwater Harvesting BMPs

[RWH-1: Cistern](#)

Evapotranspiration BMPs

[ET-1: Green Roof](#)

[ET-2: Hydrologic Source Controls](#)

Biofiltration BMPs

[BIO-1: Bioretention with Underdrain](#)

[BIO-2: Planter Box](#)

[BIO-3: Vegetated Swale](#)

[BIO-4: Vegetated Filter Strip](#)

[BIO-5: Proprietary Biotreatment](#)

Treatment Control Measures

[TCM-1: Dry Extended Detention Basin](#)

[TCM-2: Wet Detention Basin](#)

[TCM-3: Constructed Wetland](#)

[TCM-4: Sand Filter](#) (if vegetated, this is considered a Biofiltration BMP)

[TCM-5: Cartridge Media Filter](#)

Pretreatment/Gross Solids Removal BMPs

[PT-1: Hydrodynamic Device](#)

[PT-2: Catch Basin Insert](#)

INF-1: Infiltration Basin

An infiltration basin consists of an earthen basin constructed in naturally pervious soils (Type A or B soils) with a flat bottom and provided with an inlet structure to dissipate energy of incoming flow and an emergency spillway to control excess flows. An optional relief underdrain may be provided to drain the basin if standing water conditions occur. A forebay settling basin or separate Treatment Control Measure must be provided as pretreatment. An infiltration basin functions by retaining the SQDV in the basin and allowing the retained runoff to percolate into the underlying native soils over a specified period of time. The bottoms of infiltration basins are typically vegetated with dry-land grasses or irrigated turf grass. A typical layout of an infiltration basin system is shown in Figure 6-2.



Infiltration Basin in a Fresno, CA Park, Before and After a Rain Event

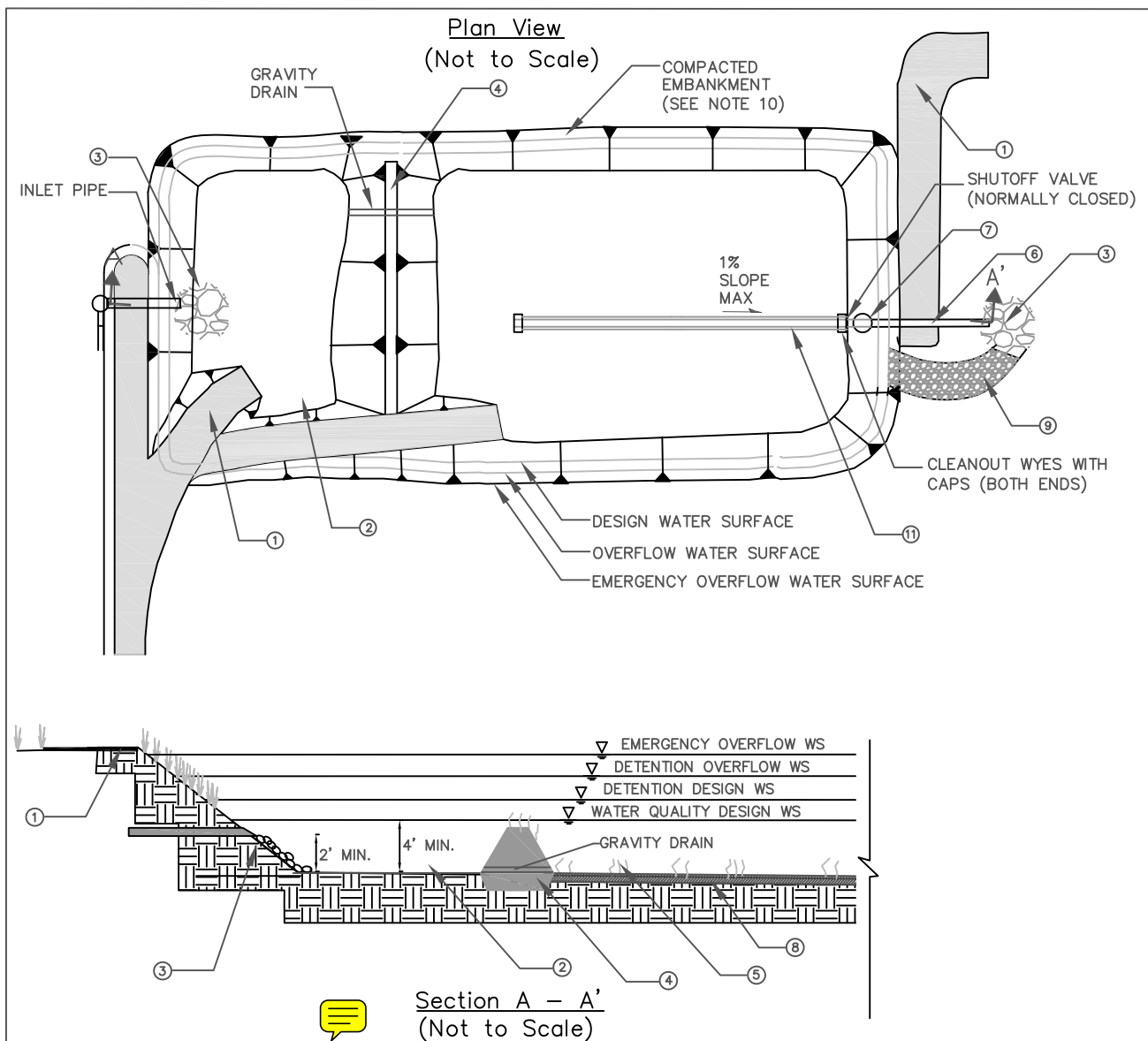
Photo Credit:

Application

- Mixed-use and commercial
- Roads and parking lots
- Parks and open spaces
- Single and multi-family residential
- Can integrate with parks


Routine Maintenance

- Removal trash, debris, and sediment at inlet and outlets
- Wet weather inspection to ensure drain time
- Remove weeds
- Inspect for mosquito breeding



NOTES:

- ① MAINTENANCE RAMP SHOULD BE PAVED. SLOPE SHOULD NOT EXCEED 10:1 H:V. MAINTENANCE RAMP SHOULD PROVIDE ACCESS TO BOTH THE FIRST CELL AND MAIN BASIN.
- ② UPSTREAM PRETREATMENT SHALL BE PROVIDED. SEDIMENT FOREBAY WITH VOLUME EQUAL TO 25% OF TOTAL INFILTRATION BASIN VOLUME MAY BE USED IN LIEU OF UPSTREAM PRETREATMENT. DEPTH SHALL BE 4' MIN TO 8' MAX PLUS AN ADDITIONAL 1 FOOT MIN SEDIMENT STORAGE DEPTH.
- ③ RIP RAP APRON OR OTHER ENERGY DISSIPATION.
- ④ EXTEND EARTHEN BERM ACROSS ENTIRE WIDTH OF THE INFILTRATION BASIN.
- ⑤ INFILTRATION BASIN BOTTOM AND SIDE SLOPES SHALL BE PLANTED WITH DROUGHT TOLERANT VEGETATION. DEEP ROOTED VEGETATION PREFERRED FOR BASIN BOTTOM. NO TOPSOIL SHALL BE ADDED TO INFILTRATION BASIN BED.
- ⑥ SIZE OUTLET PIPE TO PASS CAPITAL DESIGN PEAK FLOW FOR ON-LINE INFILTRATION BASINS AND WATER QUALITY PEAK FLOW FOR OFF-LINE INFILTRATION BASINS.
- ⑦ WATER QUALITY OUTLET STRUCTURE. SEE FIGURE 7-2 AND FIGURE 7-3 FOR DETAILS.
- ⑧ OVER EXCAVATE BASIN BOTTOM 1 FOOT. RE-PLACE EXCAVATED MATERIAL UNIFORMLY WITHOUT COMPACTION. AMENDING EXCAVATED MATERIAL WITH 2" - 4" OF COARSE SAND IS RECOMMENDED FOR SOILS WITH BORDER LINE INFILTRATION CAPACITY.
- ⑨ INSTALL EMERGENCY OVERFLOW SPILLWAY AS NEEDED. SEE FIGURE 2-4 FOR DETAILS.
- ⑩ EMBANKMENT SIDE SLOPES SHALL BE NO STEEPER THAN 3H:1V BOTH OUTSIDE AND INSIDE.
- ⑪ INSTALL OPTIONAL 6" MINIMUM DIAMETER PERFORATED PIPE UNDERDRAIN. INSTALL AT 0.5% MINIMUM SLOPE.

	
<p>Figure 6-2: Infiltration Basin</p>	

Limitations

The following limitations should be considered before choosing to use an infiltration basin:

- Native soil infiltration rate - permeability of soils at the infiltration basin location must be at least 0.5 inches per hour.
- Depth to groundwater, bedrock, or low permeability soil layer – 5 feet vertical separation is required between the bottom of the infiltration basin and the seasonal high groundwater level or mounded groundwater level, bedrock, or other barrier to infiltration to ensure that the facility will completely drain between storms and that infiltrating water will receive adequate treatment through the soils before it reaches the groundwater.
- Slope stability - infiltration BMPs must be sited at least 50 feet away from slopes steeper than 15 percent.
- Setbacks - a minimum setback (100 feet or more) must be provided between infiltration BMPs and potable wells, non-potable wells, drain fields, and springs. Infiltration BMPs must be setback at least eight feet from building foundations or have an alternative setback established by the geotechnical expert for the project.
- Groundwater contamination - the application of infiltration BMPs should include significant pretreatment in an area identified as an unconfined aquifer to ensure groundwater is protected for pollutants of concern.
- Contaminated soils or groundwater plumes - infiltration BMPs are not allowed at locations with contaminated soils or groundwater, where the pollutants could be mobilized or exacerbated by infiltration, unless a site-specific analysis determines the infiltration would be beneficial.
- High pollutant land uses - infiltration BMPs should not be placed in high-risk areas such as at or near service/gas stations, truck stops, and heavy industrial sites due to the groundwater contamination risk unless a site-specific evaluation demonstrates that sufficient pretreatment is provided to address pollutants of concern, high risks areas are isolated from stormwater runoff, or infiltration areas have little chance of spill migration.
- High sediment loading rates – infiltration BMPs may clog quickly if sediment loads are high (e.g., unstabilized site) or if flows are not adequately pretreated.

Additional Control Functions

Infiltration basins can be designed for flow control by providing storage capacity in excess of that provided by infiltration and incorporating outlet controls. The additional storage and outlet structure shall be provided per the requirements outlined in the [Dry Extended Detention Basins](#) section of the 2010 TGM. Note that the selected outlet structure shall not be designed to drain the design volume intended for infiltration and shall be similar to outlet structures that maintain a permanent pool (see Section 6.10.2 – Wet Retention Basins).

Multi-Use Opportunities

Infiltration basins may be integrated into the design of a park or playfield. Recreational multi-use facilities must be inspected after every storm and may require a greater maintenance frequency than dedicated infiltration basins to ensure aesthetics and public safety are not compromised. Any planned multi-use facility must obtain approval by the affected City and County departments.

Design Criteria

The main challenge associated with infiltration basins is preventing system clogging and subsequent infiltration inhibition. Infiltration basins should be designed according to the requirements listed in Table 6-1 and outlined in the section below. Detailed design procedures and an example are included in Appendix E.

Table 6-1: Infiltration Basin Design Criteria

Design Parameter	Unit	Design Criteria
Stormwater quality design volume (SQDV)	acre-feet	See Section 2.3 and Appendix E for calculating SQDV
Design drawdown time	hr	12 - 72 (See Appendix D, Section D.2)
Bottom basin Elevation	feet	5 feet above seasonally high groundwater table or mounded groundwater
Setbacks	feet	100 feet from wells, fields, and springs; 20 feet downslope of 100 feet upslope of foundations; Geotechnical expert should establish the setback requirement from building foundations that must be ≥ 8 ft.
Pretreatment	-	Sedimentation forebay or any Treatment Control Measure shall be provided as pretreatment for all tributary surfaces other than roofs.

Design Parameter	Unit	Design Criteria
Design percolation rate (P_{design})	in/hr	Measured percolation rate must be corrected based onsite suitability assessment and design related considerations described in this fact sheet.
Embankment side slope (H:V)	-	$\geq 4:1$ inside $\geq 3:1$ outside (without retaining walls)
Facility geometry	-	Forebay (if applicable): 25% of facility volume; flat bottom slope
Freeboard (minimum)	ft	1.0
Inlet/ Outlet erosion control	-	Energy dissipater to reduce velocity
Overflow device	-	Required if system is on-line
Maintenance access ramp width	feet	16, paved with asphalt concrete
Maintenance access ramp slope	H:V	10:1 or flatter

Geotechnical Considerations

An extensive geotechnical site investigation must be undertaken early in the site planning process to verify site suitability for the installation of infiltration facilities, due to the potential to contaminate groundwater, cause slope instability, impact surrounding structures, and have insufficient infiltration capacity.. Soil infiltration rates and the water table depth should be evaluated to ensure that conditions are satisfactory for proper operation of an infiltration facility. See Appendix C for guidance on infiltration testing.

The project designer must demonstrate through infiltration testing, soil logs, and the written opinion of a licensed civil engineer that sufficiently permeable soils exist onsite to allow the construction of a properly functioning infiltration facility.

- 1) Infiltration facilities require a minimum soil infiltration rate of 0.5 inches/hour. Pretreatment is required in all instances.
- 2) Groundwater separation must be at least 5 feet from the basin bottom to the measured [Seasonal High Groundwater Elevation](#) or estimated high groundwater mounding elevation. Groundwater levels measurements must be made during the time when water level is expected to be at a maximum (i.e., toward the end of the wet season).

- 3) Potential BMP sites with a slope greater than 25% (4:1) shall be excluded. A geotechnical analysis and report addressing slope stability are required if located within 50 feet of slopes greater than 15%.

Soil Assessment and Site Geotechnical Investigation Reports

The soil assessment report should:

- State whether the site is suitable for the proposed infiltration basin;
- Recommend a design percolation rate (see “*Step 2: Determine The Design Percolation Rate*” below);
- Identify the seasonally high depth to groundwater table surface elevation;
- Provide a good understanding of how the stormwater runoff will move in the soil (horizontally or vertically) and if there are any geological conditions that could inhibit the movement of water; and
- If a geotechnical investigation and report are required, the report should:
 - Provide a written opinion by a professional civil engineer describing whether the infiltration basin will compromise slope stability; and
 - Identify potential impacts to nearby structural foundations.

Setbacks

- 1) Infiltration facilities shall be setback a minimum of 100 feet from proposed or existing potable wells, non-potable wells, septic drain fields, and springs.
- 2) Infiltration BMPs must be sited at least 50 feet away from slopes steeper than 15 percent.
- 3) The geotechnical expert shall establish the setback requirement from building foundations that must be ≥ 8 ft.

Pretreatment

Pretreatment is required for infiltration basins in order to reduce the sediment load entering the facility and maintain the infiltration rate of the facility. Pretreatment refers to design features that provide settling of large particles before runoff reaches a management practice; easing the long-term maintenance burden. Pretreatment is important for most all structural stormwater BMPs, but it is particularly important for infiltration BMPs. To ensure that pretreatment mechanisms are effective, designers should incorporate sediment reduction practices. Sediment reduction BMPs may include vegetated swales, vegetated filter strips, sedimentation basins or forebays, sedimentation manholes and hydrodynamic separation devices. The use of at least two pretreatment devices is highly recommended for infiltration basins.

For design specification of selected pre-treatment devices, refer to:

- [BIO-3: Vegetated swales](#)
- [BIO-4: Vegetated filter strips](#)
- [TCM-4: Sand filters](#)
- [TCM-5: Cartridge media filters](#)
- [PT-1: Hydrodynamic separation device](#)

Sizing Criteria

As with sand filters, infiltration facilities can be sized using one of two methods: a simple sizing method or a routing modeling method. With either method the SQDV volume must be completely infiltrated within 12 to 72 hours (see Appendix D, Section D.2 for a discussion on drawdown time and BMP performance). The simple sizing procedures provided below can be used for either infiltration basins or infiltration trenches (see [INF-2: Infiltration Trench](#)). For the routing modeling method, refer to [TCM-4 Sand Filters](#).

Step 1: Calculate the Design Volume

Infiltration facilities shall be sized to capture and infiltrate the SQDV volume (see [Section 2](#) and Appendix E) with a 12 to 72 hour drawdown time (see Appendix D, Section D.2).

Step 2: Determine the Design Percolation Rate

The percolation rate will decline between maintenance cycles as the surface becomes occluded and particulates accumulate in the infiltrative layer. Monitoring of actual facility performance has shown that the full-scale infiltration rate is far lower than the rate measured by small-scale testing. It is important that adequate conservatism is incorporated in the selection of design percolation rates. For infiltration trenches, the design percolation rate discussed here is the percolation rate of the underlying soils and not the percolation rate of the filter media bed (refer to the “[Geometry and Sizing](#)” section of INF-2 for the recommended composition of the filter media bed for infiltration trenches).

Considerations for Design Percolation Rate Corrections

Suitability assessment related considerations include (Table 6-2):

- Soil assessment methods – the site assessment extent (e.g., number of borings, test pits, etc.) and the measurement method used to estimate the short-term infiltration rate.

- Predominant soil texture/percent fines – soil texture and the percent fines can greatly influence the potential for clogging.
- Site soil variability – site with spatially heterogeneous soils (vertically or horizontally), as determined from site investigations, are more difficult to estimate average properties resulting in a higher level of uncertainty associated with initial estimates.
- Depth to seasonal high groundwater/impervious layer – groundwater mounding may become an issue during excessively wet conditions where shallow aquifers or shallow clay lenses are present.

Table 6-2: Suitability Assessment Related Considerations for Infiltration Facility Safety Factors

Consideration	High Concern	Medium Concern	Low Concern
Assessment methods	Use of soil survey maps or simple texture analysis to estimate short-term infiltration rates	Direct measurement of ≥ 20 percent of infiltration area with localized infiltration measurement methods (e.g., infiltrometer)	Direct measurement of ≥ 50 percent of infiltration area with localized infiltration measurement methods or Use of extensive test pit infiltration measurement methods
Ventura Hydrology Manual soil number (measured infiltration rate)	3 ($f = 0.5 - 0.64$)	4 or 5 ($f = 0.65 - 0.91$)	6 or 7 ($f = 0.92$ or higher)
Site soil variability	Highly variable soils indicated from site assessment or limited soil borings collected during site assessment	Soil borings/test pits indicate moderately homogeneous soils	Multiple soil borings/test pits indicate relatively homogeneous soils
Depth to groundwater/impervious layer	<10 ft below facility bottom	10-30 ft below facility bottom	>30 below facility bottom

Localized infiltration testing refers to methods such as the double ring infiltrometer test (ASTM D3385-88), which measure infiltration rates over an area less than 10 sq-

ft and do not attempt to account for soil heterogeneity. Extensive infiltration testing refers to methods that include excavating a significant portion of the proposed infiltration area, filling the excavation with water, and monitoring drawdown. In all cases, testing should be conducted in the area of the proposed BMP where, based on geotechnical data, soils appear least likely to support infiltration.

Design related considerations include (Table 6-3):

- Size of area tributary to facility – all things being equal, both physical and economic risk factors related to infiltration facilities increase with an increase in the tributary area served. Therefore facilities serving larger tributary areas should use more restrictive adjustment factors.
- Level of pretreatment/expected influent sediment loads – credit should be given for good pretreatment by allowing less restrictive factors to account for the reduced probability of clogging from high sediment loading. Also, facilities designed to capture runoff from relatively clean surfaces such as rooftops are likely to see low sediment loads and therefore should be allowed to apply less restrictive safety factors.
- Redundancy – facilities that consist of multiple subsystems operating in parallel such that parts of the system remains functional when other parts fail and/or bypass, should be rewarded for the built-in redundancy with less restrictive correction and safety factors. For example, if bypass flows would be at least partially treated by another BMP, the risk of discharging untreated runoff in the event of clogging the primary facility is reduced. A bioretention facility that overflows to a landscaped area is another example. Compaction during construction – proper construction oversight is needed during construction to ensure that the bottoms of infiltration facility are not overly compacted. Facilities that do not commit to proper construction practices and oversight should have to use more restrictive correction and safety factors.

Table 6-3: Design Related Considerations for Infiltration Facility Safety Factors

Consideration	High Concern	Medium Concern	Low Concern
Tributary area size	Greater than 10 acres.	Greater than 2 acres but less than 10 acres.	2 acres or less.
Level of pre-treatment/ expected influent sediment loads	Pre-treatment from gross solids removal devices only, such as hydrodynamic separators, racks and screens, AND tributary area includes landscaped areas, steep slopes, high traffic areas, or any other areas expected to produce high sediment, trash, or debris loads.	Good pre-treatment with BMPs that mitigate coarse sediments such as vegetated swales AND influent sediment loads from the tributary area are expected to be relatively low (e.g., low traffic, mild slopes, disconnected impervious areas, etc.).	Excellent pre-treatment with BMPs that mitigate fine sediments such as bioretention or media filtration OR sedimentation or facility only treats runoff from relatively clean surfaces, such as rooftops.
Redundancy of treatment	No redundancy in BMP treatment train.	Medium redundancy, other BMPs available in treatment train to maintain at least 50% of function of facility in event of failure.	High redundancy, multiple components capable of operating independently and in parallel, maintaining at least 90% of facility functionality in event of failure.
Compaction during construction	Construction of facility on a compacted site or elevated probability of unintended/ indirect compaction.	Medium probability of unintended/ indirect compaction.	Heavy equipment actively prohibited from infiltration areas during construction and low probability of unintended/ indirect compaction.

Adjust the measured short-term infiltration rate using a weighted average of several safety factors using the worksheet shown in Table 6-4 below. The design percolation rate would be determined as follows:

- For each consideration shown in Table 6-2 and Table 6-3 above, determine whether the consideration is a high, medium, or low concern.
- For all high concerns, assign a factor value of 3, for medium concerns, assign a factor value of 2, and for low concerns assign a factor value of 1.
- Multiply each of the factors by the corresponding weight to get a product.

- Sum the products within each factor category to obtain a safety factor for each.
- Multiply the two safety factors together to get the final combined safety factor. If the combined safety factor is less than 2, then use 2 as the safety factor.
- Divide the measured short-term infiltration rate by the combined safety factor to obtain the adjusted design percolation rate for use in sizing the infiltration facility.

Table 6-4: Infiltration Facility Safety Factor Determination Worksheet

Factor Category		Factor Description	Assigned Weight (w)	Factor Value (v)	Product (p) p = w x v
A	Suitability Assessment	Soil assessment methods	0.25		
		Predominant soil texture	0.25		
		Site soil variability	0.25		
		Depth to groundwater / impervious layer	0.25		
		Suitability Assessment Safety Factor, $S_A = \sum p$			
B	Design	Tributary area size	0.25		
		Level of pre-treatment/ expected sediment loads	0.25		
		Redundancy	0.25		
		Compaction during construction	0.25		
		Design Safety Factor, $S_B = \sum p$			
Combined Safety Factor = $S_A \times S_B$					

Note: The minimum combined adjustment factor shall not be less than 2.0 and the maximum combined adjustment factor shall not exceed 9.

Step 3: Calculate the surface area

Determine the size of the required infiltrating surface by assuming the SQDV will fill the available ponding depth plus (for infiltration trenches) the void spaces based on the computed porosity of the filter media (normally about 32%).

- 1) Determine the maximum depth of runoff that can be infiltrated within the required drain time (d_{max}) as follows:

$$d_{max} = \frac{P_{design}}{12} t \tag{Equation 6-1}$$

Where:

d_{max}	=	the maximum depth of water that can be infiltrated within the required drain time (ft)
P_{design}	=	design percolation rate of underlying soils (in/hr)
t	=	required drain time (hrs)

2) Choose the ponding depth (d_p) and/or trench depth (d_t) such that:

$$d_{max} \geq d_p \quad \text{For Infiltration Basins} \quad (\text{Equation 6-2})$$

$$d_{max} \geq n_t d_t + d_p \quad \text{For Infiltration Trenches} \quad (\text{Equation 6-3})$$

Where:

d_{max}	=	the maximum depth of water that can be infiltrated within the required drain time (ft)
d_p	=	ponding depth (ft)
n_t	=	trench fill aggregate porosity (unitless)
d_t	=	depth of trench fill (ft)

3) Calculate infiltrating surface area (filter bottom area) required:

$$A = \frac{SQDV}{((TP_{design}/12) + d_p)} \quad \text{For Infiltration Basins} \quad (\text{Equation 6-4})$$

$$A = \frac{SQDV}{((TP_{design}/12) + n_t d_t + d_p)} \quad \text{For Infiltration Trenches} \quad (\text{Equation 6-5})$$

Where:

$SQDV$	=	stormwater quality design volume (ft ³)
n_t	=	trench fill aggregate porosity (unitless)
P_{design}	=	design percolation rate (in/hr)
d_p	=	ponding depth (ft)
d_t	=	depth of trench fill (ft)
T	=	fill time (time to fill to max ponding depth with water) (hrs) [use 2 hours for most designs]

Geometry and Sizing

- 1) Infiltration basins shall be designed and constructed with the flattest bottom slope possible to promote uniform ponding and infiltration across the facility.
- 2) A sediment forebay is required unless adequate pretreatment is provided in a separate pretreatment unit (e.g., vegetated swale, filter strip, hydrodynamic device) to reduce sediment loads entering the infiltration basin. The sediment forebay, if present, shall have a volume equal to 25% of the total infiltration basin volume.
- 3) The forebay shall be designed with a minimum length to width ratio of 2:1 and must completely drain to the main basin through an 8-inch minimum low-flow outlet within 10 minutes.
- 4) All inlets shall enter the sediment forebay. If there are multiple inlets, the length-to-width ratio shall be based on the average flowpath length for all inlets.
- 5) Design embankments to conform to requirements of the State of California Division of Safety of Dams, if the basin dimensions cause it to fall under that agency's jurisdiction. Interior slopes should be no steeper than 4:1 and exterior slopes no steeper than 3:1. Flatter slopes are preferable.

Drainage

- 1) The bottom of the infiltration bed must be native soil, over-excavated to at least one foot in depth, and replaced uniformly without compaction. Amending the excavated soil with 2-4 inches (~15-30%) of coarse sand is recommended.
- 2) The hydraulic conductivity of the subsurface layers shall be sufficient to ensure a maximum 72-hr drawdown time. An observation well shall be incorporated to allow observation of drain time.
- 3) For infiltration basins, an underdrain shall be installed within the bottom layer to provide drainage in case of standing water. The underdrain shall be operated by opening a valve, which shall be closed during normal operation. Cleanouts shall be provided for the underdrain. See Sand Filter Section VEG-8 for specifications for underdrains.

Emergency Overflow

- 1) There must be an overflow route for stormwater flows that overtop the facility or in case the infiltration facility becomes clogged.
- 2) The overflow channel must be able to safely convey flows from the peak design storm to the downstream stormwater conveyance system or other acceptable discharge point.

- 3) Spillway and overflow structures should be designed in accordance with applicable standards of the Ventura County Flood Control District or local jurisdiction.

Vegetation

- 1) A thick mat of drought tolerant grass shall be established on the basin floor and side-slopes following construction. Grasses can help prevent erosion and increase evapotranspiration and their roots discourage compaction helping to maintain the surface infiltration rates. Additionally, the active growing vegetation can help break up surface layers that accumulate fine particulates.
- 2) Grass may need to be irrigated during establishment.
- 3) For infiltration basins, landscaping of the area surrounding the basin must adhere to the following criteria so as not to hinder maintenance operations:
 - a. No trees or shrubs may be planted within 10 feet of inlet or outlet pipes or manmade drainage structures such as spillways, flow spreaders, or earthen embankments. Species with roots that seek water, such as willow or poplar, shall not be used within 50 feet of pipes or manmade structures. Weeping willows (*Salix babylonica*) shall not be planted in or near detention basins.
 - b. Prohibited non-native plant species will not be permitted. For more information on invasive weeds, including biology and control of listed weeds, look at the encyclopedias located at the California Department of Food and Agriculture website or the California Invasive Plant Council website at www.cal-ipc.org.

Maintenance Access

- 1) Maintenance access road(s) shall be provided to the drainage structures associated with the basin (e.g., inlet, emergency overflow, or bypass structures). Manhole and catch basin lids must be in or at the edge of the access road.
- 2) An access ramp to the basin bottom is required to facilitate the entry of sediment removal and vegetation maintenance equipment without compaction of the basin bottom and side slopes.
- 3) Access roads shall meet the following design criteria:
 - a. A graded 16-foot wide maintenance ramp shall be provided that extends to the bottom of the infiltration basin near the outlet.
 - b. A 16-foot wide commercial driveway approach shall be provided where curb and gutter front the maintenance ramp.

Construction Considerations

To preserve and avoid the loss of infiltration capacity, the following construction guidelines are specified:

- 1) The entire area draining to the facility must be stabilized before construction begins. If this is impossible, a diversion berm must be placed around the perimeter of the infiltration site to prevent sediment entrance during construction.
- 2) Infiltration basins should not be hydraulically connected to the stormwater conveyance system until all contributing tributary areas are stabilized as shown on the Contract Plans and to the satisfaction of the Engineer. Infiltration basins should not be used as sediment control facilities.
- 3) Compaction of the subgrade with heavy equipment should be minimized to the maximum extent possible. If the use of heavy equipment on the base of the facility cannot be avoided, the infiltrative capacity should be restored by tilling or aerating prior to placing the infiltrative bed.
- 4) The exposed soils must be inspected by a civil engineer after excavation to confirm that soil conditions are suitable.

Operations and Maintenance

Infiltration facility maintenance shall include frequent inspections to ensure that surface ponding infiltrates into the subsurface completely within the design infiltration time after a storm (see Appendix I for an infiltration BMP inspection and maintenance checklist).

Maintenance and regular inspections are of primary importance if infiltration BMPs are to continue to function as originally designed. A specific maintenance plan shall be formulated specifically for each facility outlining the schedule and scope of maintenance operations, as well as the data handling and reporting requirements. The following are general maintenance requirements:

- 1) Regular inspection shall determine if the pretreatment sediment removal BMPs require routine maintenance.
- 2) If water is noticed in the basin more than 72 hours after a major storm the infiltration facility may be clogged. Maintenance activities triggered by a potentially clogged facility include:
 - a. Check for debris/sediment accumulation, rake surface, and remove sediment (if any) and evaluate potential sources of sediment and debris (e.g., embankment erosion, channel scour, overhanging trees, etc). If suspected upland sources are outside of the immediate jurisdiction,

- additional pretreatment operations (e.g., trash racks, vegetated swales, etc.) may be necessary.
- b. For basins, removal of the top layer of native soil may be required to restore infiltrative capacity.
 - c. Any debris or algae growth located on top of the infiltration facility shall be removed and disposed of properly.
 - d. Facilities shall be inspected annually. Trash and debris shall be removed as needed, but at least annually prior to the beginning of the wet season.
- 3) Site vegetation shall be maintained as frequently as necessary to maintain the aesthetic appearance of the site, and as follows:
- a. Vegetation, large shrubs, or trees that limit access or interfere with basin operation shall be pruned or removed.
 - b. Slope areas that have become bare shall be revegetated and eroded areas shall be regraded prior to being revegetated.
 - c. Grass shall be mowed to 4"-9" high and grass clippings shall be removed.
 - d. Fallen leaves and debris from deciduous plant foliage shall be raked and removed.
 - e. Invasive vegetation, such as Alligatorweed (*Alternanthera philoxeroides*), Halogeton (*Halogeton glomeratus*), Spotted Knapweed (*Centaurea maculosa*), Giant Reed (*Arundo donax*), Castor Bean (*Ricinus communis*), Perennial Pepperweed (*Lepidium latifolium*), and Yellow Starthistle (*Centaurea solstitialis*) must be removed and replaced with non-invasive species. Invasive species shall never contribute more than 25% of the vegetated area. For more information on invasive weeds, including biology and control of listed weeds, look at the encyclopedias located at the California Department of Food and Agriculture website or the California Invasive Plant Council website at www.cal-ipc.org.
 - f. Dead vegetation shall be removed if it exceeds 10% of area coverage. Vegetation shall be replaced immediately to maintain cover density and control erosion where soils are exposed.
- 4) For infiltration basins, sediment build-up exceeding 50% of the forebay capacity shall be removed. Sediment from the remainder of the basin shall be removed when 6 inches of sediment accumulates. Sediments shall be tested for toxic substance accumulation in compliance with current disposal requirements if land uses in the catchment include commercial or industrial zones, or if visual or olfactory indications of pollution are noticed. If toxic substances are encountered at concentrations exceeding thresholds of Title 22, Section 66261 of the

California Code of Regulations, the sediment must be disposed of in a hazardous waste landfill and the source of the contaminated sediments shall be investigated and mitigated to the extent possible.

- 5) Following sediment removal activities, replanting and/or reseeded of vegetation may be required for reestablishment.

INF-2: Infiltration Trench

Infiltration trenches are long, narrow, gravel-filled trenches, often vegetated, that infiltrate stormwater runoff from small drainage areas. Infiltration trenches may include a shallow depression at the surface, but the majority of runoff is stored in the void space within the gravel and infiltrates through the sides and the bottom of the trench.



Infiltration Trench

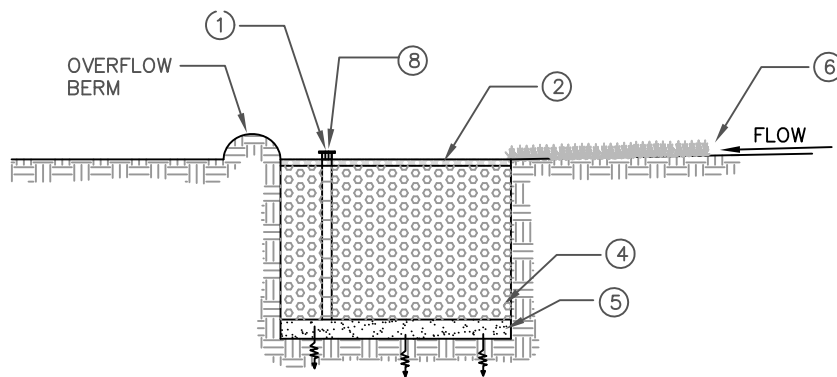
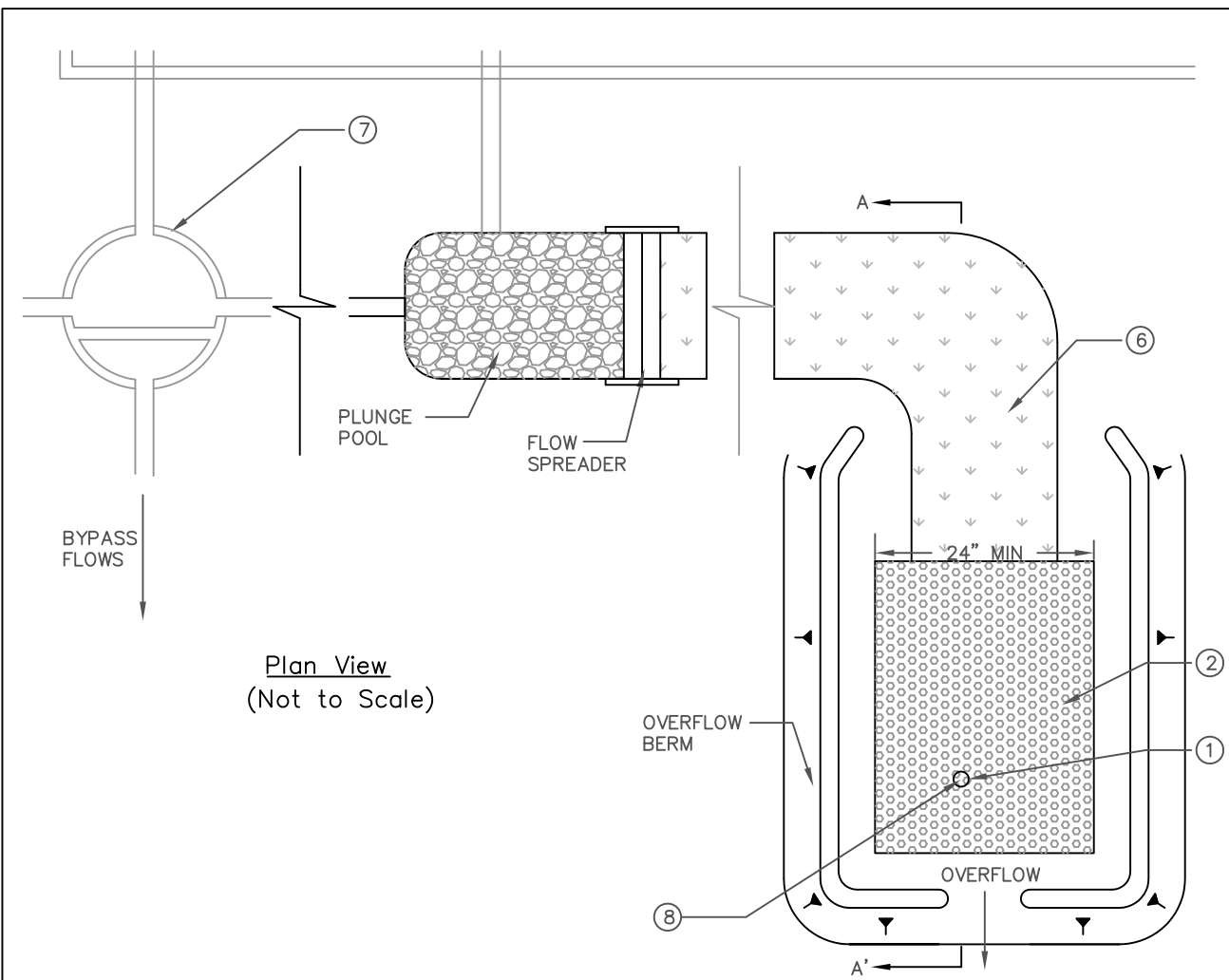
<http://stormwater.wordpress.com/2007/05/23/infiltration--trenches/>

Application

- Open areas adjacent to parking lots, driveways, and buildings
- Roadway medians and shoulders

Routine Maintenance

- Removal trash, debris, and sediment at inlet and outlets
- Wet weather inspection to ensure drain time
- Remove weeds
- Inspect for mosquito breeding



NOTES:

- ① OBSERVATION WELL WITH LOCKABLE ABOVE-GROUND CAP.
- ② 2" PEA GRAVEL FILTER LAYER.
- ③ MINIMUM 10' ABOVE SEASONAL HIGH GROUNDWATER TABLE AND 3' ABOVE BEDROCK.
- ④ 3' - 5' DEEP TRENCH FILLED WITH 2" - 6" DIAMETER CLEAN STONE WITH 30% - 40% VOIDS.
- ⑤ 6" DEEP SAND FILTER LAYER (OR FABRIC EQUIVALENT).
- ⑥ RUNOFF FILTERS THROUGH GRASS FILTER STRIP OR VEGETATED SWALE.
- ⑦ OPTIONAL FLOW CONTROL DEVICE FOR OFF-LINE CONFIGURATIONS.
- ⑧ AFFIX PERMANENT IDENTIFICATION TAG.



Figure 6-3: Infiltration Trench

Limitations

The following limitations should be considered before choosing to use an infiltration trench:

- Native soil infiltration rate – soil permeability at the infiltration trench location must be at least 0.5 inches per hour.
- Depth to groundwater, bedrock, or low permeability soil layer – 5 feet vertical separation is required between the bottom of the infiltration trench and the seasonal high groundwater level or mounded groundwater level, bedrock, or other barrier to infiltration to ensure that the facility will completely drain between storms and that infiltrating water will receive adequate treatment through the soils before it reaches the groundwater.
- Slope stability - infiltration BMPs must be sited at least 50 feet away from slopes steeper than 15 percent.
- Setbacks - a minimum setback (100 feet or more) must be provided between infiltration BMPs and potable wells, non-potable wells, drain fields and springs. Infiltration BMPs must be setback from building foundations at least eight feet or an alternative setback established by the geotechnical expert for the project.
- Groundwater contamination - the application of infiltration BMPs should include significant pretreatment in an area identified as an unconfined aquifer to ensure groundwater is protected for pollutants of concern.
 - Contaminated soils or groundwater plumes - infiltration BMPs are not allowed at locations with contaminated soils or groundwater where the pollutants could be mobilized or exacerbated by infiltration, unless a site-specific analysis determines that infiltration would be beneficial.
- High pollutant land uses - infiltration BMPs should not be placed in high-risk areas such as at or near service/gas stations, truck stops, and heavy industrial sites due to the groundwater contamination risk unless a site-specific evaluation demonstrates that sufficient pretreatment is provided to address pollutants of concern, high risks areas are isolated from stormwater runoff, or infiltration areas have little chance of spill migration.
- High sediment loading rates – infiltration BMPs may clog quickly if sediment loads are high (e.g., unstabilized site) or if flows are not adequately pretreated.

Design Criteria

The main challenge associated with infiltration trenches is preventing system clogging and subsequent infiltration inhibition. Infiltration trenches should be designed according to the requirements listed in Table 6-5 and outlined in the section below. BMP sizing worksheets are presented in Appendix E.

Table 6-5: Infiltration Trench Design Criteria

Design Parameter	Unit	Design Criteria
Stormwater quality design volume (SQDV)	acre-feet	See Section 2 and Appendix E for calculating SQDV.
Design drawdown time	hr	12 – 72, see Appendix D, Section D.2
Trench bottom elevation	feet	5 feet from seasonally high groundwater table
Setbacks	feet	100 feet from wells, fields, springs Geotechnical expert should establish the setback requirement from building foundations that must be ≥ 8 ft Do not locate under tree drip-lines
Pretreatment	-	BIO-3: Vegetated Swale , BIO-4: Filter Strip , proprietary device, or sedimentation forebay, for all surfaces other than roofs
Design percolation rate, (P_{design})	in/hr	Measured percolation rate must be corrected based onsite suitability assessment and design related considerations described in this fact sheet
Maximum depth of facility (d_{max})	feet	8.0; Defined by the design infiltration rate and the design drawdown time (includes ponding depth and depth of media)
Surface area of facility (A)	square feet	Based on depth of ponding (if applicable) and depth of trench media
Facility geometry	-	Minimum 24 inches wide and maximum 5 feet deep; max 3% bottom slope
Filter media diameter	inches	1 – 3 (gravel); prefabricated media may also be used
Trench lining material	-	Geotextile fabric
Overflow device	-	Required if system is on-line

Geotechnical Considerations

An extensive geotechnical site investigation must be undertaken early in the site planning process to verify site suitability for the installation of infiltration facilities due to the potential to contaminate groundwater, cause slope instability, impact surrounding structures, and have insufficient infiltration capacity. Soil infiltration rates and the water table depth should be evaluated to ensure that conditions are satisfactory for proper operation of an infiltration facility. See Appendix C for guidance on infiltration testing.

The project designer must demonstrate through infiltration testing, soil logs, and the written opinion of a licensed civil engineer that sufficiently permeable soils exist onsite to allow the construction of a properly functioning infiltration facility.

- 1) Infiltration facilities require a minimum soil infiltration rate of 0.5 inches/hour. If infiltration rates exceed 2.4 inches/hour, then the runoff should be fully treated in an upstream BMP prior to infiltration to protect groundwater quality. Pretreatment for coarse sediment removal is required in all instances.
- 2) Groundwater separation must be at least 5 feet from the trench bottom to the measured season high groundwater elevation or estimated high groundwater mounding elevation. Groundwater level measurements must be made during the time when water level is expected to be at a maximum (i.e., toward the end of the wet season).
- 3) Sites with a slope greater than 25% (4:1) shall be excluded. A geotechnical analysis and report addressing slope stability are required if located on slopes greater than 15%.

Soil Assessment and Site Geotechnical Investigation Reports

The soil assessment report should:

- State whether the site is suitable for the proposed infiltration trench;
- Recommend a design infiltration rate (see the Step 2 of sizing methodology section, “Determine the design percolation rate,” in the Infiltration Basin fact sheet above);
- Identify the seasonally high depth to groundwater table surface elevation.
- Provide a good understanding of how the stormwater runoff will move in the soil (horizontally or vertically) and if there are any geological conditions that could inhibit the movement of water; and
- If a geotechnical investigation and report are required, the report should:
 - Provide a written opinion by a professional civil engineer describing whether the infiltration trench will compromise slope stability; and

- Identify potential impacts to nearby structural foundations.

Setbacks

- 1) Infiltration facilities shall be setback a minimum of 100 feet from proposed or existing potable wells, non-potable wells, septic drain fields, and springs.
- 2) Infiltration BMPs must be sited at least 50 feet away from slopes steeper than 15 percent.
- 3) Infiltration BMPs must be setback from building foundations at least eight feet or an alternative setback established by the geotechnical expert for the project.

Pretreatment

Pretreatment is required for infiltration trenches in order to reduce the sediment load entering the facility and maintain the infiltration rate of the facility. Pretreatment refers to design features that provide settling of large particles before runoff reaches a management practice; easing the long-term maintenance burden. Pretreatment is important for most all structural stormwater BMPs, but it is particularly important for infiltration BMPs. To ensure that pretreatment mechanisms are effective, designers should incorporate sediment reduction practices. Sediment reduction BMPs may include vegetated swales, vegetated filter strips, sedimentation basins or forebays, sedimentation manholes and hydrodynamic separation devices.


For design specification of selected pre-treatment devices, refer to:

- [VEG-3: Vegetated swales](#)
- [VEG-4: Vegetated filter strips](#)
- [TCM-4: Sand filters](#)
- [TCM-5: Cartridge media filters](#)
- [PT-1: Hydrodynamic separation device](#)

Sizing Criteria

See [Sizing Criteria](#) section in the INF-1: Infiltration Basin fact sheet.

Geometry and Sizing

- 1) Infiltration trenches should be at least 2 feet wide and 3 to 5 feet deep. 
- 2) The longitudinal slope of the trench should not exceed 3%.
- 3) The filter bed media layers should have the following composition and thickness:

- a. Top layer – If stormwater runoff enters the top of the trench via sheet flow at the ground surface, then the top 2 inches should be pea gravel with a thin 2 to 4 inch layer of pure sand and 2 inch layer of choking stone (e.g., #8) to capture sediment before entering the trench. If stormwater runoff enters the trench from an underground pipe, pretreatment prior to entry into the trench is required.
 - b. Middle layer (3 to 5 feet of washed, 1.5 to 3 inch gravel). Void space should be in the range of 30 percent to 40 percent.
 - c. Bottom layer (6 inches of clean, washed sand to encourage drainage and prevent compaction of the native soil while the stone aggregate is added).
- 4) One or more observation wells should be installed, depending on trench length, to check for water level, drawdown time, and evidence of clogging. A typical observation well consists of a slotted PVC well screen, 4 to 6 inches in diameter, capped with a lockable, above-ground lid.


Drainage

- 1) The bottom of the infiltration bed must be native soil, over-excavated to at least one foot in depth and replaced uniformly without compaction. Amending the excavated soil with 2 to 4 inches (~15% to 30%) of coarse sand is recommended.
- 2) The hydraulic conductivity of the subsurface layers should be sufficient to ensure the design drawdown time. An observation well should be incorporated to allow observation of drain time.

Emergency Overflow

- 1) There must be an overflow route for stormwater flows that overtop the facility or in case the infiltration facility becomes clogged.
- 2) The overflow channel must be able to safely convey flows from the peak design storm to the downstream stormwater conveyance system or other acceptable discharge point.

Vegetation

- 1) Trees and other large vegetation should be planted away from trenches such that drip lines do not overhang infiltration beds. 

Maintenance Access

- 1) The facility and outlet structures must all be safely accessible during wet and dry weather conditions.
- 2) An access road along the length of the trench is required, unless the trench is located along an existing road or parking lot that can be safely used for maintenance access.

- 3) If the infiltration trench becomes plugged and fails, then access is needed to excavate the facility to remove and replace the top layer or the filter bed media, as well as to increase all dimensions of the facility by 2 inches to provide a fresh surface for infiltration. To prevent damage and compaction, access must be able to accommodate a backhoe working at “arms length”.

Construction Considerations

To preserve and avoid the loss of infiltration capacity, the following construction guidelines are specified:

- 1) The entire area draining to the facility must be stabilized before construction begins. If this is impossible, a diversion berm must be placed around the perimeter of the infiltration site to prevent sediment entering during construction.
- 2) Infiltration trenches should not be hydraulically connected to the stormwater conveyance system until all contributing tributary areas are stabilized as shown on the Contract Plans and to the satisfaction of the Engineer. Infiltration trenches should not be used as sediment control facilities.
- 3) Compaction of the subgrade with heavy equipment should be minimized to the maximum extent possible. If the use of heavy equipment on the base of the facility cannot be avoided, the infiltrative capacity should be restored by tilling or aerating prior to placing the infiltrative bed.
- 4) The exposed soils must be inspected by a civil engineer after excavation to confirm that soil conditions are suitable.

Operations and Maintenance

Infiltration facility maintenance should include frequent inspections to ensure that water infiltrates into the subsurface completely within the design drawdown time after a storm.

Maintenance and regular inspections are of primary importance if infiltration trenches are to continue to function as originally designed. A specific maintenance plan shall be developed specific to each facility outlining the schedule and scope of maintenance operations, as well as the documentation and reporting requirements. The following are general maintenance requirements:

- 1) Regular inspection should determine if the sediment pretreatment structures require preventative maintenance. Inspect a minimum of twice a year, before and after the rainy season, after large storms, or more frequently if needed.
- 2) If water is noticed in the observation well of the infiltration trench more than 72 hours after a major storm, the infiltration trench may be clogged. Maintenance activities triggered by a potentially clogged facility include:

- a. For trenches, assess the condition of the top aggregate layer for sediment buildup and crusting. Remove top layer of pea gravel and replace. If slow draining conditions persist, entire trench may need to be excavated and replaced.
- 3) Any debris or algae growth located on top of the infiltration facility should be removed and disposed of properly.
- 4) Inspect a minimum of twice a year, before and after the rainy season, after large storms, or more frequently if needed.
- 5) Clean when loss of infiltrative capacity is observed. If drawdown time is observed to have increased significantly over the design drawdown time, removal of sediment may be necessary. This is an expensive maintenance activity and the need for it can be minimized through prevention of upstream erosion.
- 6) Mow as appropriate for vegetative cover species.
- 7) Monitor health of vegetation and replace as necessary.
- 8) Control mosquitoes as necessary.
- 9) Remove litter and debris from trench area as required.

INF-3: Bioretention

Bioretention stormwater treatment facilities are landscaped shallow depressions that capture and filter stormwater runoff. These facilities function as a soil and plant-based filtration device that removes pollutants through a variety of physical, biological, and chemical treatment processes. The facilities normally consist of a ponding area, mulch layer, planting soils, and plantings. As stormwater passes down through the planting soil, pollutants are filtered, adsorbed, and biodegraded by the soil and plants. For areas with low permeability native soils or steep slopes, bioretention areas can be designed with an underdrain system that routes the treated runoff to the storm drain system rather than depending entirely on infiltration. See the section [BIO-1: Bioretention with Underdrain](#) for relevant design specifications.



Bioretention in Parkway and parking lots

Photo Credits: Geosyntec Consultants

Application

- Commercial, residential, mixed use, institutional, and recreational uses
- Parking lot islands, traffic circles
- Road parkways & medians

Preventative Maintenance

- Repair small eroded areas
- Remove trash and debris and rake surface soils
- Remove accumulated fine sediments, dead leaves and trash
- Remove weeds and prune back excess plant growth
- Remove sediment and debris accumulation near inlet and outlet structures
- Periodically observe function under wet weather conditions

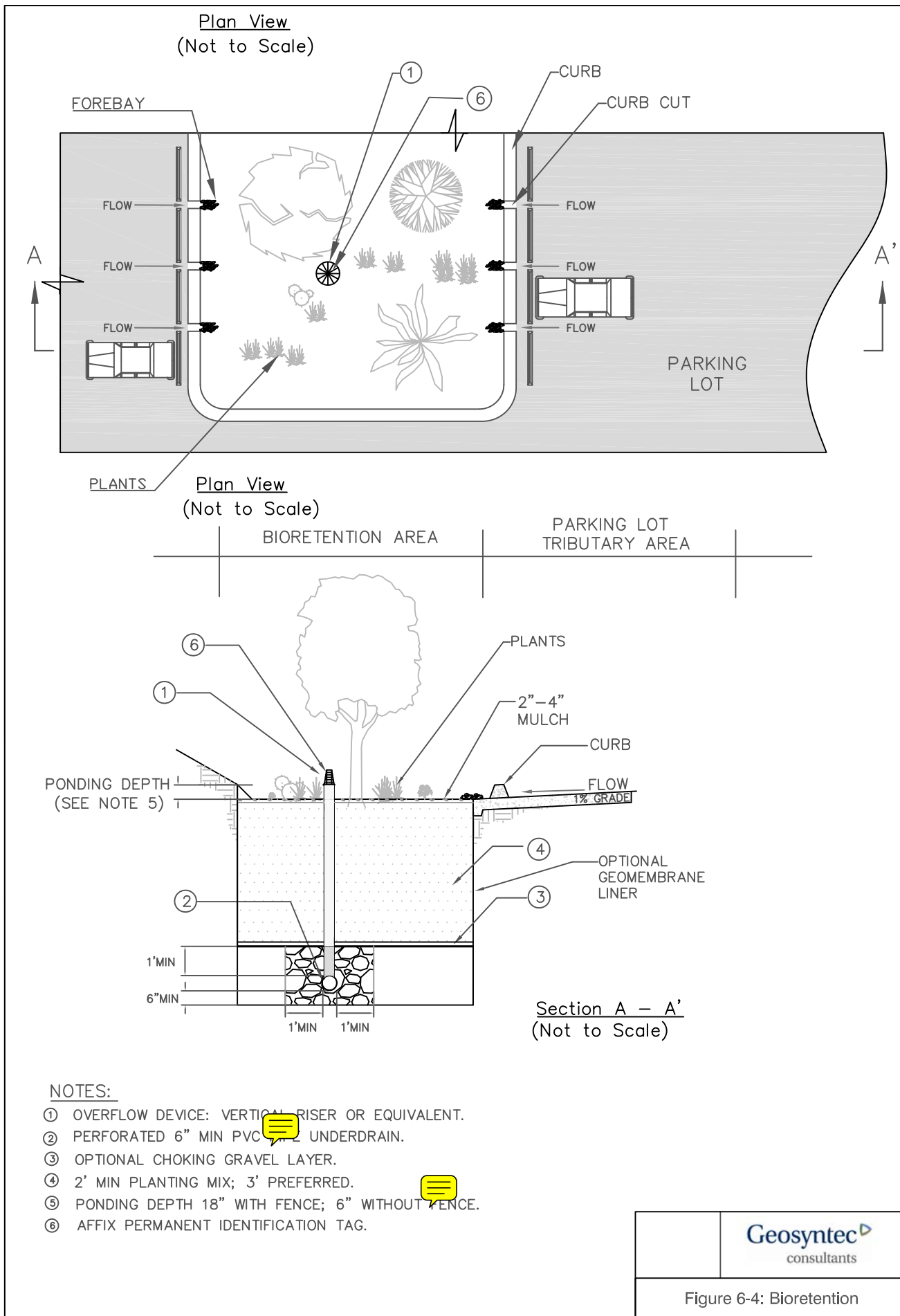


Figure 6-4: Bioretention

Limitations


The following limitations should be considered before choosing to use bioretention:

- 1) Native soil infiltration rate - soil permeability at the BMP location must be at least 0.5 inches per hour.
- 2) Depth to groundwater, bedrock, or low permeability soil layer – 5 feet vertical separation is required between the bottom of the infiltration trench and the seasonal high groundwater level or mounded groundwater level, bedrock, or other barrier to infiltration to ensure that the facility will completely drain between storms and that infiltrating water will receive adequate treatment through the soils before it reaches the groundwater.
- 3) Slope stability - infiltration BMPs must be sited at least 50 feet away from slopes steeper than 15 percent.
- 4) Setbacks - a minimum setback (100 feet or more) must be provided between infiltration BMPs and potable wells, non-potable wells, drain fields, and springs. Infiltration BMPs must be setback from building foundations at least eight feet or have an alternative setback established by the geotechnical expert for the project.
- 5) Groundwater contamination - the application of infiltration BMPs should include significant pretreatment in an area identified as an unconfined aquifer to ensure groundwater is protected for pollutants of concern.
- 6) Contaminated soils or groundwater plumes - infiltration BMPs are not allowed at locations with contaminated soils or groundwater where the pollutants could be mobilized or exacerbated by infiltration, unless a site-specific analysis determines that infiltration would be beneficial.
- 7) High pollutant land uses - infiltration BMPs should not be placed in high-risk areas such as at or near service/gas stations, truck stops, and heavy industrial sites due to the groundwater contamination risk unless a site-specific evaluation demonstrates that sufficient pretreatment is provided to address pollutants of concern, high risk areas are isolated from stormwater runoff, or infiltration areas have little chance of spill migration.
- 8) High sediment loading rates – infiltration BMPs may clog quickly if sediment loads are high (e.g., unstabilized site) or if flows are not adequately pretreated. Underdrains are required if the site soil percolation rate is less than 0.5 inches per hour (see VEG-1: Bioretention with Underdrain for relevant design specifications).
- 9) Vertical relief and proximity to storm drain - site must have adequate relief between the land surface and storm drain to permit vertical percolation through the soil media and collection. Sites with steep slopes (greater than 20%) must incorporate a weep garden.

Design Criteria

Bioretention should be designed according to the requirements listed in Table 6-6 and outlined in the section below. BMP sizing worksheets are presented in Appendix E.

Table 6-6: Bioretention Design Criteria

Design Parameter	Unit	Design Criteria
Stormwater quality design volume (SQDV)	acre-feet	See Section 2 and Appendix E for calculating SQDV.
Forebay	-	Forebay should be provided for all tributary surfaces that contain landscaped areas. Forebays should be designed to prevent standing water during dry weather and should be planted with a plant palette that is tolerant of wet conditions.
Maximum drawdown time of water ponded on surface	hours	48
Maximum drawdown time of surface ponding plus subsurface pores	hours	96 (72 preferred)
Maximum ponding depth	inches	18 inches if fenced,  6 inches without fencing
Minimum thickness of amended soil	feet	2 (3 preferred)
Minimum thickness of stabilized mulch	inches	2 to 3
Planting mix composition	-	60 to 70% sand, 15 to 25% compost, 10 to 20% clean topsoil; organic content 8 to 12%; pH 5.5 to 7.5
Overflow device	-	Required
Maximum side slope	H:V	2:1 for ≤ 6 inch ponding; 3:1 for > 6 inch ponding; Vertical walls may be used with reviewer approval; Design shall provide documentation of how energy dissipation, public safety, and geotechnical considerations are addressed.

Sizing Criteria

Bioretention facilities can be sized using one of two methods: a simple sizing method or a routing modeling method. With either method the SQDV volume must be completely infiltrated within 96 hours (including subsurface pore space), and surface ponding must be infiltrated within 48 hours. The simple sizing procedure is provided below. For the routing modeling method, refer to [TCM-4 Sand Filters](#).

Step 1: Calculate the Design Volume

Bioretention facilities shall be sized to capture and infiltrate the SQDV volume (see Section 2.3 and Appendix E).

Step 2: Determine the Design Percolation Rate

The percolation rate will decline between maintenance cycles as the surface becomes occluded and particulates accumulate in the infiltration layer. Monitoring of actual facility performance has shown that the full-scale infiltration rate is far lower than the rate measured by small-scale testing. It is important that adequate conservatism is incorporated in the selection of design percolation rates. For bioretention facilities, the design percolation rate discussed here is the adjusted percolation rate of the underlying soils and not the percolation rate of the filter media bed.

Considerations for Design Percolation Rate Corrections

Suitability assessment-related considerations include (Table 6-7):

- Soil assessment methods – the site assessment extent (e.g., number of borings, test pits, etc.) and the measurement method used to estimate the short-term infiltration rate.
- Predominant soil texture/percent fines – soil texture and the percent of fines can greatly influence the potential for clogging.
- Site soil variability – site with spatially heterogeneous soils (vertically or horizontally) as determined from site investigations are more difficult to estimate average properties, resulting in a higher level of uncertainty associated with initial estimates.
- Depth to seasonal high groundwater/impervious layer – groundwater mounding may become an issue during excessively wet conditions where shallow aquifers or shallow clay lenses are present.

Table 6-7: Suitability Assessment Related Considerations for Infiltration Facility Safety Factors

Consideration	High Concern	Medium Concern	Low Concern
Assessment methods	Use of soil survey maps or simple texture analysis to estimate short-term infiltration rates	Direct measurement of ≥ 20 percent of infiltration area with localized infiltration measurement methods (e.g., infiltrometer)	Direct measurement of ≥ 50 percent of infiltration area with localized infiltration measurement methods or Use of extensive test pit infiltration measurement methods
Ventura Hydrology Manual soil number (measured infiltration rate)	3 ($f = 0.5 - 0.64$)	4 or 5 ($f = 0.65 - 0.91$)	6 or 7 ($f = 0.92$ or higher)
Site soil variability	Highly variable soils indicated from site assessment or limited soil borings collected during site assessment	Soil borings/test pits indicate moderately homogeneous soils	Multiple soil borings/test pits indicate relatively homogeneous soils
Depth to groundwater/impervious layer	< 10 ft below facility bottom	10-30 ft below facility bottom	> 30 below facility bottom

Localized infiltration testing refers to methods such as the double ring infiltrometer test (ASTM D3385-88), which measure infiltration rates over an area less than 10 sq-ft and do not attempt to account for soil heterogeneity. Extensive infiltration testing refers to methods that include excavating a significant portion of the proposed infiltration area, filling the excavation with water, and monitoring drawdown. In all cases, testing should be conducted in the area of the proposed BMP where, based on geotechnical data, soils appear least likely to support infiltration.

Design related considerations include:

- Size of area tributary to facility – all things being equal, both physical and economic risk factors related to infiltration facilities increase with an increase in the tributary area served. Therefore facilities serving larger tributary areas should use more restrictive adjustment factors.
- Level of pretreatment/expected influent sediment loads – credit should be given for good pretreatment by allowing less restrictive factors to account for the

reduced probability of clogging from high sediment loading. Also, facilities designed to capture runoff from relatively clean surfaces such as rooftops are likely to see low sediment loads and therefore should be allowed to apply less restrictive safety factors.

- Redundancy – facilities that consist of multiple subsystems operating in parallel such that parts of the system remain functional when other parts fail and/or bypass should be rewarded for the built-in redundancy with less restrictive correction and safety factors. For example, if bypass flows would be at least partially treated in another BMP, the risk of discharging untreated runoff in the event of clogging the primary facility is reduced. A bioretention facility that overflows to a landscaped area is another example.
- Compaction during construction – proper construction oversight is needed during construction to ensure that the bottoms of bioretention facility are not overly compacted. Facilities that do not commit to proper construction practices and oversight should have to use more restrictive correction and safety factors.

Table 6-8: Design Related Considerations for Infiltration Facility Safety Factors

Consideration	High Concern	Medium Concern	Low Concern
Tributary area size	Greater than 10 acres.	Greater than 2 acres but less than 10 acres.	2 acres or less.
Level of pre-treatment/ expected influent sediment loads	Pre-treatment from gross solids removal devices only, such as hydrodynamic separators, racks and screens, AND tributary area includes landscaped areas, steep slopes, high traffic areas, or any other areas expected to produce high sediment, trash, or debris loads.	Good pre-treatment with BMPs that mitigate coarse sediments such as vegetated swales AND influent sediment loads from the tributary area are expected to be relatively low (e.g., low traffic, mild slopes, disconnected impervious areas, etc.).	Excellent pre-treatment with BMPs that mitigate fine sediments such as bioretention or media filtration OR sedimentation or facility only treats runoff from relatively clean surfaces, such as rooftops.
Redundancy of treatment	No redundancy in BMP treatment train.	Medium redundancy, other BMPs available in treatment train to maintain at least 50% of function of facility in event of failure.	High redundancy, multiple components capable of operating independently and in parallel, maintaining at least 90% of facility functionality in event of failure.

Consideration	High Concern	Medium Concern	Low Concern
Compaction during construction	Construction of facility on a compacted site or elevated probability of unintended/ indirect compaction.	Medium probability of unintended/ indirect compaction.	Heavy equipment actively prohibited from infiltration areas during construction and low probability of unintended/ indirect compaction.

Adjust the measured short-term infiltration rate using a weighted average of several safety factors using the worksheet shown in Table 6-9 below. The design percolation rate would be determined as follows:

- For each consideration shown in Tables 6-7 and 6-8 above, determine whether the consideration is a high, medium, or low concern.
- For all high concerns assign a factor value of 3, for medium concerns assign a factor value of 2, and for low concerns assign a factor value of 1.
- Multiply each of the factors by the corresponding weight to get a product.
- Sum the products within each factor category to obtain a safety factor for each.
- Multiply the two safety factors together to get the final combined safety factor. If the combined safety factor is less than 2, then use 2 as the safety factor.
- Divide the measured short-term infiltration rate by the combined safety factor to obtain the adjusted design percolation rate for use in sizing the infiltration facility.

Table 6-9: Infiltration Facility Safety Factor Determination Worksheet

Factor Category		Factor Description	Assigned Weight (w)	Factor Value (v)	Product (p) p = w x v
A	Suitability Assessment	Soil assessment methods	0.25		
		Predominant soil texture	0.25		
		Site soil variability	0.25		
		Depth to groundwater / impervious layer	0.25		
		Suitability Assessment Safety Factor, $S_A = \Sigma p$			
B	Design	Tributary area size	0.25		
		Level of pre-treatment/ expected sediment loads	0.25		
		Redundancy	0.25		
		Compaction during construction	0.25		
		Design Safety Factor, $S_B = \Sigma p$			
Combined Safety Factor = $S_A \times S_B$					

Note: The minimum combined adjustment factor shall not be less than 2.0 and the maximum combined adjustment factor shall not exceed 9.

Step 3: Calculate the surface area

Determine the size of the required infiltrating surface by assuming the SQDV will fill the available ponding depth plus the void spaces in the media, based on the computed porosity of the filter media and optional aggregate layer.

- 1) Determine the maximum depth of surface ponding that can be infiltrated within the required surface drain time (48 hr), (d_{max}), as follows:

$$d_{max} = \frac{P_{design} \times t_{ponding}}{12 \frac{in}{ft}} \quad \text{(Equation 6-6)}$$

Where:

- $t_{ponding}$ = required drain time of surface ponding (48 hrs)
- P_{design} = design percolation rate of underlying soils (in/hr) (see Step 2, above)
- d_{max} = the maximum depth of surface ponding water that can be infiltrated within the required drain time (ft), calculated using Equation 6-6

- 2) Choose surface ponding depth (d_p) such that:

$$d_p \leq d_{max} \quad (\text{Equation 6-7})$$

Where:

- d_p = selected surface ponding depth (ft)
- d_{max} = the maximum depth of water that can be infiltrated within the required drain time (ft)

Choose thickness(es) of amended media and aggregate layer(s) and calculate total effective storage depth of the bioretention area ($d_{effective}$), as follows:

$$d_{effective} \leq (d_p + n_{media}^* l_{media} + n_{gravel} l_{gravel}) \quad (\text{Equation 6-8})$$

Where:

- $d_{effective}$ = total equivalent depth of water stored in bioretention area (ft), including surface ponding and volume available in pore spaces of media and gravel layers
- d_p = surface ponding depth (ft), chosen using Equation 6=7
- n_{media}^* = available porosity of amended soil media (ft/ft), approximately 0.25 ft/ft accounting for antecedent moisture conditions. This represents the volume of available pore space as a fraction of the total soil volume; sometimes has units of (ft³/ft³) or described as a percentage.
- l_{media} = thickness of amended soil media layer (ft), minimum 2 ft
- n_{gravel} = porosity of optional gravel layer (ft/ft), approximately 0.30 ft/ft
- l_{gravel} = thickness of optional gravel layer (ft)

3) Check that entire effective depth (surface plus subsurface storage), (deffective), infiltrates in no greater than 96 hours as follows:

$$t_{total} = \frac{d_{effective}}{P_{design}} \times 12 \frac{in}{ft} \leq 96 \text{ hr} \quad (\text{Equation 6-9})$$

Where:

- $d_{effective}$ = total equivalent depth of water stored in bioretention area (ft), calculated using Equation 6-8

P_{design} = design percolation rate of underlying soils (in/hr) (see Step 2, above)

If $t_{total} > 96$ hrs, then reduce surface ponding depth and/or amended media thickness and/or gravel thickness and return to 1).

If $t_{total} \leq 96$ hrs, then proceed to 5).

- 4) Calculate required infiltrating surface area (filter bottom area), (A_{req}):

$$A_{req} = \frac{SQDV}{d_{effective}} \quad \text{(Equation 6-10)}$$

Where:

A_{req} = required area at bottom of filter area (ft²); does not account for side slopes and freeboard

$SQDV$ = stormwater quality design volume (ft³)

$d_{effective}$ = total equivalent depth of water stored in bioretention area (ft), calculated using Equation 6-8

- 5) Calculate total footprint required by including a buffer for side slopes and freeboard; A_{req} is measured at the filter bottom area (toe of side slopes).

Geometry

- 1) Bioretention areas shall be sized to capture and treat the stormwater quality design volume (See Section 2 and Appendix E for calculating SQDV) with an 18-inch maximum ponding depth if fenced to prevent access, or 6 inches without fencing.
- 2) Minimum planting soil depth should be 2 feet, although 3 feet is preferred. *The intention is that the minimum planting soil depth should provide a beneficial root zone for the chosen plant palette and adequate water storage for the SQDV.*
- 3) A gravel drainage layer below bioretention soil media is optional.
- 4) Bioretention should be designed to drain below the planting soil in less than 48 hours and completely drain in less than 96 hours. *The intention is that soils must be allowed to dry out periodically in order to restore hydraulic capacity to receive flows from subsequent storms, maintain infiltration rates, maintain adequate soil oxygen levels for healthy soil biota and vegetation, and to provide proper soil conditions for biodegradation and retention of pollutants.*

Flow Entrance and Energy Dissipation

The following types of flow entrance can be used for bioretention cells:

- 1) Dispersed, low velocity flow across a landscape area. Dispersed flow may not be possible given space limitations or if the facility is controlling roadway or parking lot flows where curbs are mandatory.
- 2) Dispersed flow across pavement or gravel and past wheel stops for parking areas.
- 3) Curb cuts for roadside or parking lot areas: curb cuts should include rock or other erosion protection material in the channel entrance to dissipate energy. Flow entrance should drop 2 to 3 inches from curb line and it should provide a settling area and periodic sediment removal of coarse material before flow dissipates to the remainder of the cell.
- 4) Pipe flow entrance: Piped entrances, such as roof downspouts, should include rock, splash blocks, or other appropriate measures at the entrance to dissipate energy and disperse flows.

Woody plants (trees, shrubs, etc.) can restrict or concentrate flows and can be damaged by erosion around the root ball and shall not be placed directly in the entrance flow path.

Overflow

An overflow device is required at the 18-inch ponding depth. The following, or equivalent should be provided:

- 1) A vertical PVC pipe (SDR 35) to act as an overflow riser.
- 2) The overflow riser(s) should be 6 inches or greater in diameter, so it can be cleaned without damage to the pipe.

The inlet to the riser should be at the ponding depth (18 inches for fenced bioretention areas and 6 inches for areas that are not fenced), and be capped with a spider cap to exclude floating mulch and debris. Spider caps should be screwed in or glued, i.e., not removable.

Hydraulic Restriction Layers

Infiltration pathways may need to be restricted due to the close proximity of roads, foundations, or other infrastructure. A geomembrane liner, or other equivalent water proofing, may be placed along the vertical walls to reduce lateral flows. This liner shall have a minimum thickness of 30 mils.

Planting/Storage Media

- 1) The planting media placed in the cell shall be highly permeable and high in organic matter (e.g., loamy sand mixed thoroughly with compost amendment) and a surface mulch layer.

- 2) Planting media shall consist of 60 to 70% sand, 15 to 25% compost, and 10 to 20% clean topsoil. The organic content of the soil mixture should be 8% to 12%; the pH range should be 5.5 to 7.5.
- 3) Sand should be free of stones, stumps, roots or other similar objects larger than 5 millimeters, and have the following gradation:

Sieve Size (ASTM D422)	% Passing
#4	100
#6	88-100
#8	79-97
#50	11-35
#200	5-15

- 4) Compost should be free of stones, stumps, roots or other similar objects larger than ¾ inches, have a particle size of 98% passing through ¾ inch screen or smaller, and meet the following characteristics:
 - Soluble salt concentration: < 10 mmhos/cm (dS/m)
 - pH: 5.0-8.5
 - Moisture: 30-60% wet weight basis
 - Organic matter: 30-65% dry weight basis
 - Stability (carbon dioxide evolution rate): >80% relative to positive control
 - Maturity (seed emergence and seedling vigor): >80% relative to positive control
 - Physical contaminants: < 1% dry weight basis
- 5) Topsoil should be free of stones, stumps, roots or other similar objects larger than 2 inches, and have the following characteristics:

Particle Size	% Passing
¾ inch	98
Sand (0.05 – 2.0 mm)	50-75
Silt (0.002 – 0.05 mm)	15-40
Clay	< 5

- Soluble salts: < 4.0 mmhos/cm (dS/m)
- pH range: 5.5 to 7.0
- Organic matter: > 5%

- Carbon to nitrogen ratio: < 20:1
 - Moisture content: 25-55%
- 6) The bioretention area shall be covered with 2 to 4 inches (average 3 inches) of mulch at the start and an additional placement of 1 to 2 inches of mulch shall be added annually. *The intention is that to help sustain the nutrient levels, suppress weeds, and maintain infiltration capacity.*
 - 7) Planting media design height shall be marked appropriately, such as with a collar on the vertical riser (if installed), or with a stake inserted 2 feet into the planting media and notched to show bioretention surface level and ponding level.
 - 8) The bioretention soil mix shall be tested and meet the following criteria:

Item	Criteria	Test Method
Corrected pH	5.5 – 7.5	ASTM D4972
Magnesium	Minimum 32 ppm	*
Phosphorus (Phosphate)	Not to exceed 69 ppm	*
Potassium (K ₂ O)	Minimum 78 ppm	*
Soluble Salts	Not to exceed 500 ppm	*

* Use authorized soil test procedures.

pH. Should the pH fall outside of the acceptable range, it may be modified with lime (to raise the pH level) or iron sulfate plus sulfur (to lower the pH level). The lime or iron sulfate must be mixed uniformly into the soil mix prior to use in bioretention facilities. Should the soil mix not meet the minimum requirement for magnesium, it may be modified with magnesium sulfate. Likewise, should the soil mix not meet the minimum requirement for potassium, it may be modified with potash. Magnesium sulfate and potash must be mixed uniformly into the soil mix prior to use in bioretention facilities.

Limestone. Limestone shall contain not less than 85 percent calcium and magnesium carbonates. Dolomitic (magnesium) limestone shall contain at least 10 percent magnesium as magnesium oxide and 85 percent calcium and magnesium carbonates.

Limestone shall conform to the following gradation:


Sieve Size	Minimum Percent Passing By Weight
No. 10	100
No. 20	98
No. 100	50

Iron Sulfate. Iron sulfate shall be a constituent of an approved horticultural product produced as a fertilizer for supplying iron and as a soil acidifier.

Magnesium Sulfate. Magnesium sulfate shall be a constituent of an approved horticultural product produced as a fertilizer.

Potash. Potash (potassium oxide) shall be a constituent of an approved horticultural product produced as a fertilizer.

Plants

- 1) Plant materials shall be tolerant of summer drought, ponding fluctuations, and saturated soil conditions for 48 to 96 hours.
- 2) It is recommended that a minimum of three types of tree, shrubs, and/or herbaceous groundcover species be incorporated to protect against facility failure due to disease and insect infestations of a single species.
- 3) Native plant species and/or hardy cultivars that are not invasive and do not require chemical inputs shall be used to the maximum extent practicable. 

Operations and Maintenance

Bioretention areas require annual plant, soil, and mulch layer maintenance to ensure optimum infiltration, storage, and pollutant removal capabilities. In general, bioretention maintenance requirements are typical landscape care procedures and include:

- 1) **Watering:** Plants should be drought-tolerant. Watering may be required during prolonged dry periods after plants are established.
- 2) **Erosion control:** Inspect flow entrances, ponding area, and surface overflow areas periodically, and replace soil, plant material, and/or mulch layer in areas if erosion has occurred (see Appendix I for a bioretention inspection and maintenance checklist). Properly designed facilities with appropriate flow velocities should not have erosion problems, except perhaps in extreme events. If erosion problems occur, the following should be reassessed: (1) flow velocities and gradients within the cell, and (2) flow dissipation and erosion protection strategies in the pretreatment area and flow entrance. If sediment is deposited in the bioretention area, immediately determine the source within the contributing area, stabilize, and remove excess surface deposits.
- 3) **Plant material:** Depending on aesthetic requirements, occasional pruning and removing of dead plant material may be necessary. Replace all dead plants and if specific plants have a high mortality rate, assess the cause and, if necessary, replace with more appropriate species. Periodic weeding is necessary until plants are established. The weeding schedule should become less frequent if the appropriate plant species and planting density have been used and, as a result, undesirable plants excluded.

- 4) **Nutrients and pesticides:** The soil mix and plants should be selected for optimum fertility, plant establishment, and growth. Nutrient and pesticide inputs should not be required and may degrade the pollutant processing capability of the bioretention area, as well as contribute pollutant loads to receiving waters. By design, bioretention facilities are located in areas where phosphorous and nitrogen levels are often elevated and these should not be limiting nutrients. If in question, have soil analyzed for fertility.
- 5) **Mulch:** Replace mulch annually in bioretention facilities where heavy metal deposition is likely (e.g., contributing areas that include industrial and auto dealer/repair parking lots and roads). In residential lots or other areas where metal deposition is not a concern, replace or add mulch as needed to maintain a 2 to 3 inch depth at least once every two years.
- 6) **Soil:** Soil mixes for bioretention facilities are designed to maintain long-term fertility and pollutant processing capability. Estimates from metal attenuation research suggest that metal accumulation should not present an environmental concern for at least 20 years in bioretention systems. Replacing mulch in bioretention facilities where heavy metal deposition is likely provides an additional level of protection for prolonged performance. If in question, have soil analyzed for fertility and pollutant levels.

INF-4: Drywell

A dry well is defined as a bored, drilled, or driven shaft or hole whose depth is greater than its width. A dry well is designed specifically for flood alleviation and stormwater disposal. Drywells are similar to infiltration trenches in their design and function, as they are designed to temporarily store and infiltrate runoff, primarily from rooftops or other impervious areas with low pollutant loading. A dry well may be either a small excavated pit filled with aggregate or a prefabricated storage chamber or pipe segment.

Dry wells can be used to reduce the increased volume of stormwater runoff caused by roofs of buildings. While generally not a significant source of runoff pollution, roofs are one of the most important sources of new or increased runoff volume from land development sites. Dry wells can also be used to indirectly enhance water quality by reducing the amount of SQDV to be treated by the other, downstream stormwater management facilities.



Drywell installation

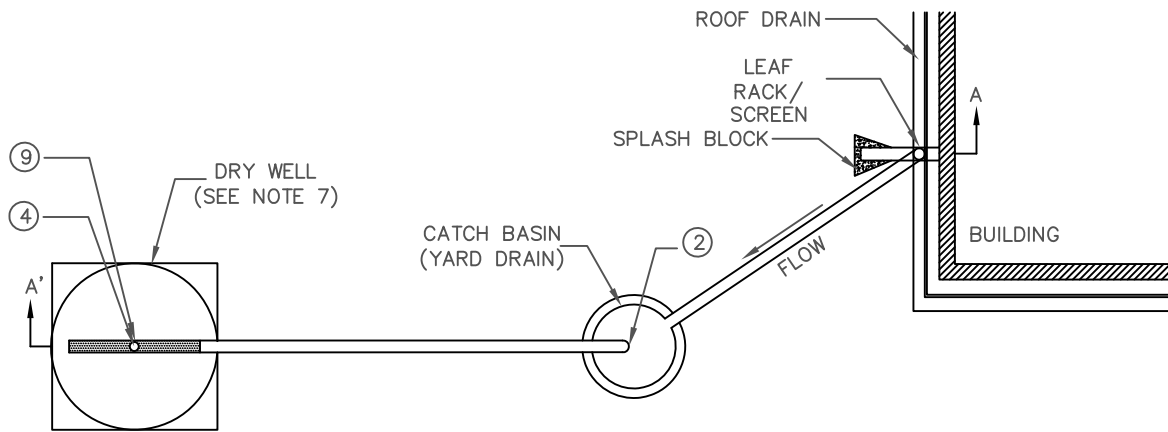
Photo Credits: 1. K&A Enterprises; 2. Canale Landscaping

Application

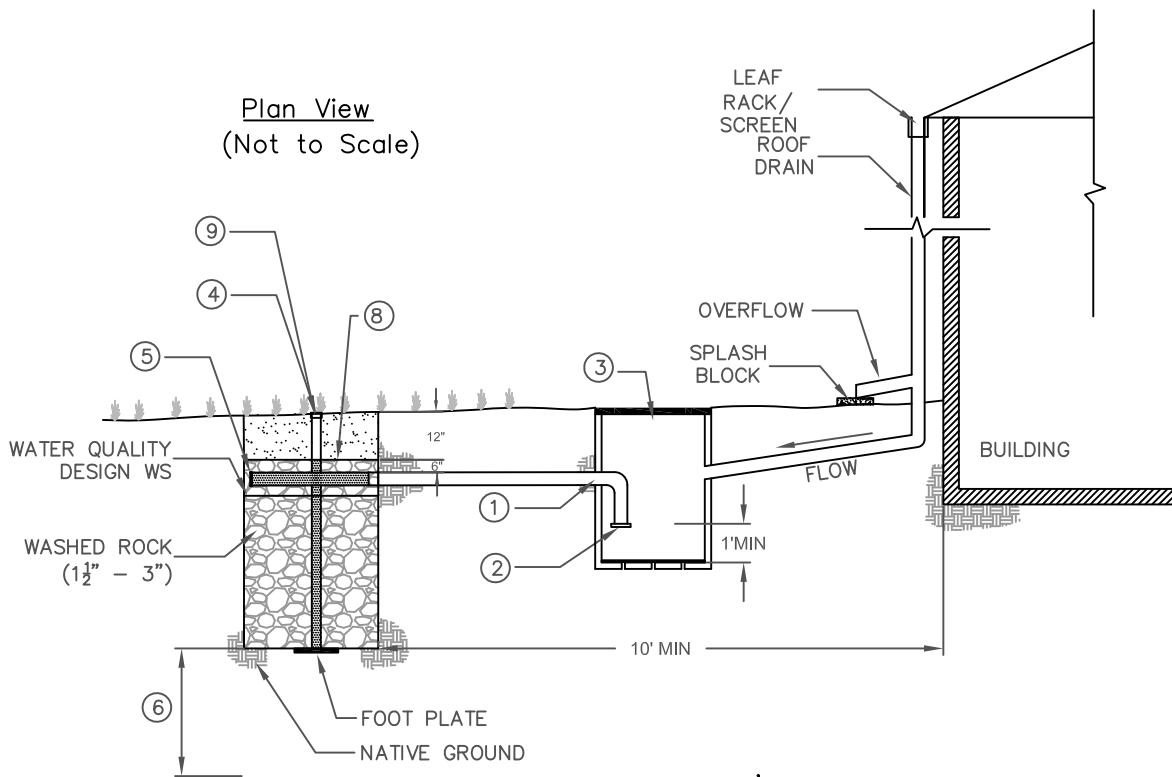
- Infiltration of roof runoff

Preventative Maintenance

- Remove trash, debris, and sediment at inlet and outlets
- Wet weather inspection to ensure drain time
- Inspect for mosquito breeding



Plan View
(Not to Scale)



Section A - A'
(Not to Scale)

NOTES:

- ① MINIMUM 4" - 6" DIAMETER PVC PIPE. INSTALL AT FLAT SLOPE.
- ② INSTALL FINE MESH SCREEN AT INLET TO DRY WELL. SET INLET ELEVATION AT 1' MINIMUM ABOVE CATCH BASIN BOTTOM.
- ③ CATCH BASIN (YARD DRAIN) INSTALLED WITH A SOLID LID FLUSH WITH GROUND SURFACE.
- ④ 4-6" VERTICAL PERFORATED PVC INSPECTION WELL WITH SCREW LID (NUT DOWN) FLUSH WITH GROUND SURFACE.
- ⑤ CAP END OF 4-6" HORIZONTAL PERFORATED PVC DISPERSION PIPE.
- ⑥ MINIMUM 10' ABOVE SEASONAL HIGH GROUNDWATER TABLE AND 3' ABOVE BEDROCK.
- ⑦ DRY WELL CONFIGURATION MAY VARY (E.G. PRE-FAB MAY BE CIRCULAR).
- ⑧ CHOKING STONE LAYER SHALL BE PLACED ON TOP OF THE DRY WELL TO SEPARATE IT FROM THE TOPSOIL AND PREVENT CLOGGING.
- ⑨ AFFIX PERMANENT IDENTIFICATION TAG.

Geosyntec
consultants

Figure 6-5: Drywell

Limitations

The following limitations shall be considered before choosing to use a dry well:

- Native soil infiltration rate – soil permeability at the infiltration basin location must be at least 0.5 inches per hour.
- Depth to groundwater, bedrock, or low permeability soil layer – 5 feet vertical separation is required between the bottom of the infiltration basin and the seasonal high groundwater level or mounded groundwater level, bedrock, or other barrier to infiltration to ensure that the facility will completely drain between storms and that infiltrating water will receive adequate treatment through the soils before it reaches the groundwater.
- Slope stability - infiltration BMPs must be sited at least 50 feet away from slopes steeper than 15 percent.
- Setbacks - a minimum setback (100 feet or more) must be provided between infiltration BMPs and potable wells, non-potable wells, drain fields, and springs. Infiltration BMPs must be setback from building foundations at least eight feet or have an alternative setback established by the geotechnical expert for the project.
- Groundwater contamination - the application of infiltration BMPs should include significant pretreatment in an area identified as an unconfined aquifer, to ensure groundwater is protected from pollutants of concern.
- Contaminated soils or groundwater plumes - infiltration BMPs are not allowed at locations with contaminated soils or groundwater where the pollutants could be mobilized or exacerbated by infiltration, unless a site-specific analysis determines the infiltration would be beneficial.
- High pollutant land uses - infiltration BMPs should not be placed in high-risk areas such as at or near service/gas stations, truck stops, and heavy industrial sites due to groundwater contamination risk unless a site-specific evaluation demonstrates that sufficient pretreatment is provided to address pollutants of concern, high risks areas are isolated from stormwater runoff, or infiltration areas have little chance of spill migration.
- High sediment loading rates – infiltration BMPs may clog quickly if sediment loads are high (e.g., unstabilized site) or if flows are not adequately pretreated.
- Dry wells cannot receive untreated stormwater runoff, except rooftop runoff. Pretreatment of runoff from other surfaces is necessary to prevent premature failure that results from clogging with fine sediment, and to prevent potential groundwater contamination due to nutrients, salts, and hydrocarbons.

- Infiltration structures cannot be used to treat runoff from portions of the site that are not stabilized.
- Rehabilitation of failed dry wells requires complete reconstruction.

Design Criteria

The main challenge associated with drywells, as with infiltration trenches, is the prevention of system clogging and subsequent infiltration inhibition. Drywells should be designed according to the requirements listed in Table 6-10 and outlined in the section below. BMP sizing worksheets are presented in Appendix E.

Table 6-10: Infiltration BMP Design Criteria

Design Parameter	Unit	Design Criteria
Stormwater quality design volume (SQDV)	acre-feet	See Section 2 and Appendix E for calculating SQDV.
Design drawdown time	hour	12
Pretreatment	-	BIO-3: Vegetated Swale , BIO-4: Filter Strip , or proprietary device
Design percolation rate (k_{design})	in/hr	Shall be corrected for testing method, potential for clogging and compaction over time, and facility geometry.
Maximum depth of facility (d_{max})	feet	Defined by the design infiltration rate and the design drawdown time (includes depth of media).
Surface area of facility (A)	ft ²	Based on depth of dry well media.
Facility geometry	-	Geometry varies; max 10 feet deep; flat bottom slope.
Filter media diameter	inches	1.5 – 3 (gravel); prefabricated media may also be used
Overflow device	-	Required if system is on-line

Geotechnical Considerations

An extensive geotechnical site investigation must be undertaken early in the site planning process to verify site suitability for the installation of infiltration facilities, due to the potential to contaminate groundwater, cause slope instability, impact surrounding structures, and have insufficient infiltration capacity. Soil infiltration rates and the water table depth should be evaluated to ensure that conditions are satisfactory for proper operation of an infiltration facility. See Appendix C for guidance on infiltration testing.

The project designer must demonstrate through infiltration testing, soil logs, and the written opinion of a licensed civil engineer that sufficiently permeable soils exist on site to allow the construction of a properly functioning infiltration facility.

- 1) Infiltration facilities require a minimum soil infiltration rate of 0.5 inches/hour. If infiltration rates exceed 2.4 inches/hour, then the runoff should be fully-treated in an upstream BMP prior to infiltration to protect groundwater quality. Pretreatment for coarse sediment removal is required in all instances.
- 2) Groundwater separation must be at least 5 feet from the basin bottom to the measured season high groundwater elevation or estimated high groundwater mounding elevation. Measurements of groundwater levels must be made during the time when water level is expected to be at a maximum (i.e., toward the end of the wet season).
- 3) Sites with a slope greater than 25% (4:1) shall be excluded. A geotechnical analysis and report addressing slope stability are required if located on slopes greater than 15%.

Soil Assessment and Site Geotechnical Investigation Reports

The soil assessment report should:

- State whether the site is suitable for the proposed drywell;
- Recommend a design infiltration rate (see the Step 2 of sizing methodology section, “Determine the design percolation rate,” in the INF-1: Infiltration Basin fact sheet above);
- Identify the seasonal high depth to groundwater table surface elevation;
- Provide a good understanding of how the stormwater runoff will move in the soil (horizontally or vertically) and if there are any geological conditions that could inhibit the movement of water; and
- If a geotechnical investigation and report are required, the report should:
 - Provide a written opinion by a professional civil engineer describing whether the drywell will compromise slope stability; and
 - Identify potential impacts to nearby structural foundations.

Setbacks

- 1) Infiltration facilities shall be setback a minimum of 100 feet from proposed or existing potable wells, non-potable wells, septic drain fields, and springs.
- 2) Infiltration BMPs must be sited at least 50 feet away from slopes steeper than 15 percent.

- 3) Infiltration BMPs must be setback from building foundations at least eight feet or have an alternative setback established by the geotechnical expert for the project.

Pretreatment

- A removable filter with a screened bottom should be installed in the roof leader below the surcharge pipe in order to screen out leaves and other debris.
- Though roofs are generally not a significant source of runoff pollution, they can still be source of particulates and organic matter. Measures such as roof gutter guards, roof leader clean-out with sump, or an intermediate sump box can provide pretreatment for dry wells by minimizing the amount of sediment and other particulates that may enter it.

Sizing Criteria

See [Sizing Criteria](#) section in the INF-1: Infiltration Basin fact sheet.

Geometry and Sizing

- 1) Dry well configurations vary, but generally they have length and width dimensions closer to square than infiltration trenches. Pre-fabricated dry-wells are often circular. The surface area of the dry well must be large enough to infiltrate the storage volume in 12 hours based on the maximum depth allowable (d_{max}).
- 2) The filter bed media layers are the same as for infiltration trenches unless prefabricated dry wells and/or media are used. The porosity of gravel media systems is generally 30 to 40% and is 80 to 95% for prefabricated media systems.
- 3) If a dry well receives runoff from an underground pipe (i.e., runoff does not enter the top of the dry well from the ground surface), a fine mesh screen should be installed at the inlet. The inlet elevation should be 18 inches below the ground surface (i.e., below 12 inches of surface soil and 6 inches of dry well media).
- 4) An observation well should be installed to check for water levels, drawdown time, and evidence of clogging. A typical observation well consists of a slotted PVC well screen, 4 to 6 inches in diameter, capped with a lockable, above-ground lid.

Drainage

- 1) The bottom of infiltration bed must be native soil, over-excavated to at least one foot in depth and replaced uniformly without compaction. Amending the excavated soil with 2 to 4 inches (~15% to 30%) of coarse sand is recommended.
- 2) The hydraulic conductivity of the subsurface layers should be sufficient to ensure a maximum 12 hr drawdown time. An observation well should be incorporated to allow observation of drain time.

Emergency Overflow

- 1) There must be an overflow route for stormwater flows that overtop the facility or in case the infiltration facility becomes clogged.
- 2) The overflow channel must be able to safely convey flows from the peak design storm to the downstream stormwater conveyance system or other acceptable discharge point.

Vegetation

- 1) Drywells should be kept free of vegetation.
- 2) Trees and other large vegetation should be planted away from drywells such that drip lines do not overhang infiltration beds.

Maintenance Access

- 1) The facility and outlet structures must all be safely accessible during wet and dry weather conditions.
- 2) An access road is required unless a drywell is located along an existing road or parking lot that can be safely used for maintenance access.
- 3) If the drywell becomes plugged and fails, then access is needed to excavate the facility to remove and replace the top layer and the filter bed media of the structure. To prevent damage and compaction, access must be able to accommodate a backhoe working at “arms length”.

Construction Considerations

To preserve and avoid the loss of infiltration capacity, the following construction guidelines must be specified:

- 1) The entire area draining to the facility must be stabilized before construction begins. If this is impossible, a diversion berm must be placed around the perimeter of the infiltration site to prevent sediment entering during construction.
- 2) Drywells should not be hydraulically connected to the stormwater conveyance system until all contributing tributary areas are stabilized as shown on the Contract Plans and to the satisfaction of the Engineer. Drywells should not be used as sediment control facilities.
- 3) Compaction of the subgrade with heavy equipment should be minimized to the maximum extent possible. If the use of heavy equipment on the base of the facility cannot be avoided, the infiltration capacity should be restored by tilling or aerating prior to placing the infiltrative bed.

- 4) The exposed soils must be inspected by a civil engineer after excavation to confirm that soil conditions are suitable.

Operations and Maintenance

Drywell maintenance should be performed frequently to ensure that water infiltrates into the subsurface completely within the recommended infiltration time (or drain time if a drywell receives runoff from an underground pipe) of 72 hours or less after a storm.

Maintenance and regular inspections are important for the proper function of drywells. A specific maintenance plan shall be developed specifically for each facility outlining the schedule and scope of maintenance operations, documentation, and reporting requirements.

INF-5: Permeable Pavement

Permeable pavements contain small voids that allow water to pass through to a stone base. They come in a variety of forms; they may be a modular paving system (concrete pavers, grass-pave, or gravel-pave) or a poured-in-place solution (porous concrete or permeable asphalt). All permeable pavements with a stone reservoir base treat stormwater and remove sediments and metals to some degree. While conventional pavement result in increased rates and volumes of surface runoff, porous pavements when properly constructed and maintained, allow some of the stormwater to percolate through the pavement and enter the soil below. This facilitates groundwater recharge while providing the structural and functional features needed for the roadway, parking lot, or sidewalk. The paving surface, subgrade, and installation requirements of permeable pavements are more complex than those for conventional asphalt or concrete surfaces. For porous pavements to function properly over an expected life span of 15 to 20 years, they must be properly sited and carefully designed and installed, as well as periodically maintained. Failure to protect paved areas from construction-related sediment loads can result in their premature clogging and failure. Note that the 2010 TGM does not provide specific instructions on how to design and construct pavement.



Application

- Parking lots
- Driveways
- Sidewalks and walkways
- Outdoor athletic courts

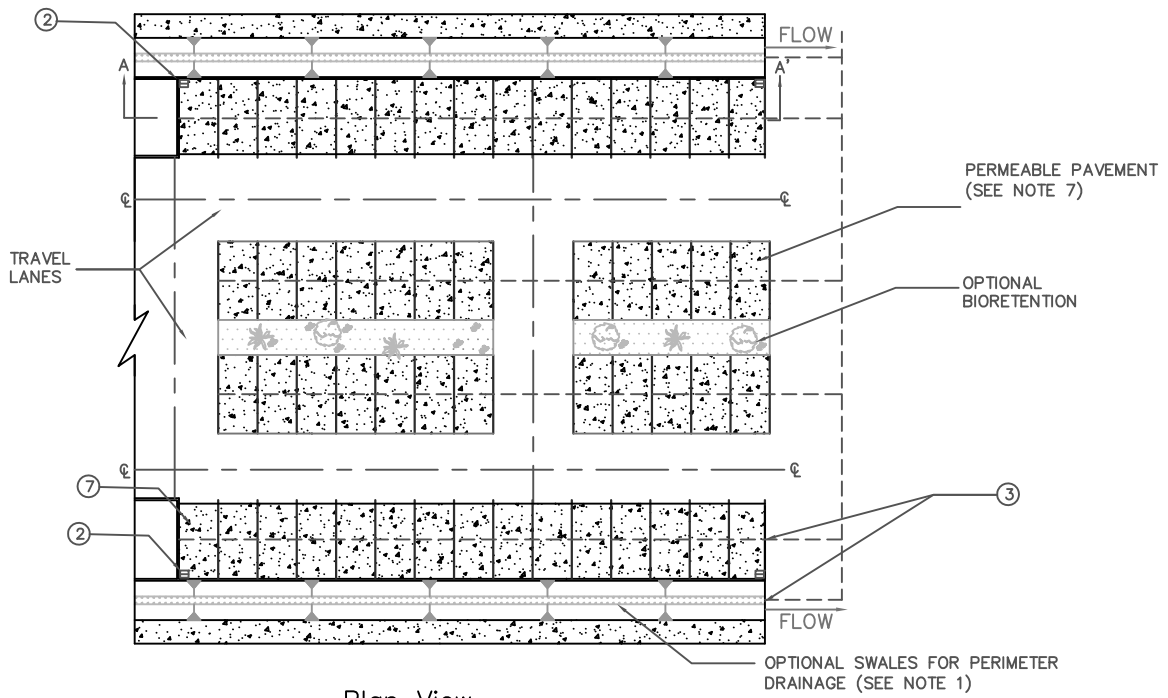


Preventative Maintenance

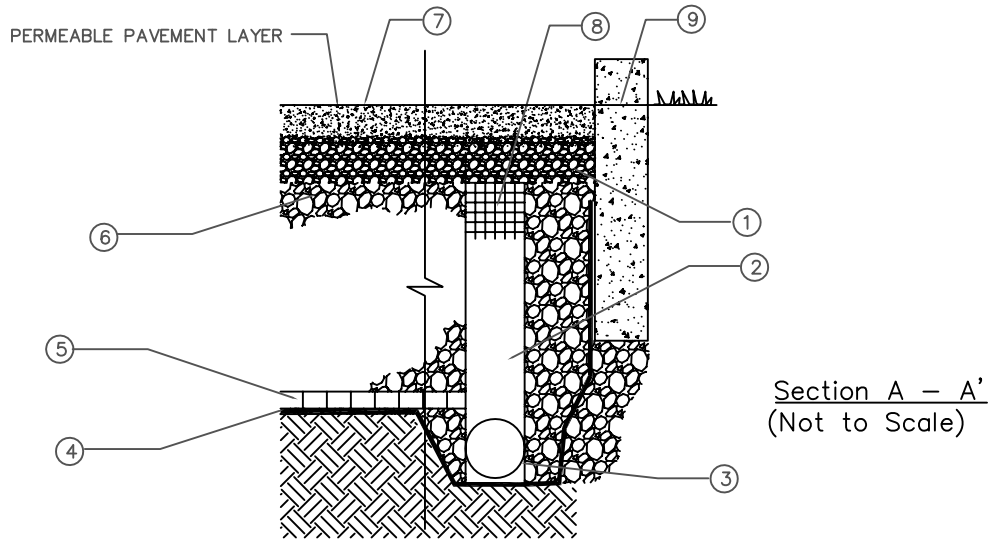
- Trash removal
- Post-rain inspections
- Vacuum sweeping
- Vegetation inspection and removal

Permeable pavement applications

Photo Credits: 1. Geosyntec Consultants; 2. EPA Stormwater Management



Plan View
(Not to Scale)



Section A - A'
(Not to Scale)

NOTES:

- ① BEDDING COURSE SHALL BE 1½" TO 3" MIN THICKNESS (TYP NO. 8 AGGREGATE).
- ② OPTIONAL FLOW PIPE(S) SHALL BE PROVIDED IF OVERFLOWS ARE NOT MANAGED VIA PERIMETER DRAINAGE SWALES, BIORETENTION OR STORM WATER CONVEYANCE SYSTEM INLETS.
- ③ CONNECT OUTFALL PIPES TO DOWNSTREAM STORMWATER CONVEYANCE SYSTEM. OUTFALL PIPES SHALL BE SLOPED TOWARDS COLLECTION SYSTEM.
- ④ SOIL SUBGRADE SHALL HAVE ZERO SLOPE.
- ⑤ INSTALL GEOTEXTILE OR CHOKING LAYER ON BOTTOM & SIDES OF OPEN-GRADED BASE FOR FULL AND PARTIAL INFILTRATION, OR AN IMPERMEABLE LINER FOR NO INFILTRATION.
- ⑥ OPEN-GRADED BASE. THICKNESS AND GRADATION VARIES WITH DESIGN. TYP. NO. 57 AGGREGATE OR 4" THICK NO. 57 OVER NO. 2 STONE SUBBASE. THICKNESS OF SUB-BASE VARIES WITH DESIGN.
- ⑦ PERMEABLE PAVEMENT INFILTRATIVE LAYER
- ⑧ OPTIONAL RIGID PLASTIC SCREEN FASTENED OVER OVERFLOW INLETS.
- ⑨ CURB/EDGE RESTRAINT WITH CUT-OUTS FOR OVERFLOW DRAINAGE TO PERIMETER BMPS, STORMWATER CONVEYANCE SYSTEM INLETS OR OPTIONAL OVERFLOW PIPES.
- ⑩ PARTIAL EXFILTRATION THROUGH THE SOIL. PERFORATED PIPES DRAIN EXCESS RUNOFF THAT CAN NOT BE ABSORBED BY SLOW-DRAINING SOIL.
- ⑪ AFFIX PERMANENT IDENTIFICATION TAG AS DIRECTED BY THE DISTRICT.



Figure 6-6: Permeable Pavement

Limitations

The following describes limitations for the use of permeable pavement.

- Native soil infiltration rate - permeability of soils at the BMP location must be at least 0.5 inches per hour.
- Depth to groundwater, bedrock, or low permeability soil layer – 5 feet vertical separation is required between the bottom of the infiltration trench and the seasonal high groundwater level or mounded groundwater level, bedrock, or other infiltration barrier to ensure that the facility will completely drain between storms and that infiltrating water will receive adequate treatment through the soils before it reaches the groundwater.
- Slope stability - infiltration BMPs must be sited at least 50 feet away from slopes steeper than 15 percent.
- Setbacks - a minimum setback (100 feet or more) must be provided between infiltration BMPs and potable wells, non-potable wells, drain fields, and springs. Infiltration BMPs must be setback from building foundations at least eight feet or an alternative setback established by the geotechnical expert for the project.
- Groundwater contamination - the application of infiltration BMPs should include significant pretreatment in an area identified as an unconfined aquifer, to ensure groundwater is protected for pollutants of concern.
- Contaminated soils or groundwater plumes - infiltration BMPs are not allowed at locations with contaminated soils or groundwater where the pollutants could be mobilized or exacerbated by infiltration, unless a site-specific analysis determines the infiltration would be beneficial.
- High pollutant land uses - infiltration BMPs should not be placed in high-risk areas such as at or near a service/gas stations, truck stops, and heavy industrial sites due to the groundwater contamination risk unless a site-specific evaluation demonstrates that sufficient pretreatment is provided to address pollutants of concern, high risk areas are isolated from stormwater runoff, or infiltration areas that have little chance of spill migration.
- High sediment loading rates – infiltration BMPs may clog quickly if sediment loads are high (e.g., unstabilized site) or if flows are not adequately pretreated.
- Permeable pavement cannot receive untreated stormwater runoff from other surfaces. Pretreatment of run-on from other surfaces is necessary to prevent premature failure that results from clogging with fine sediment.
- Permeable pavement cannot be used to treat runoff from portions of the site that are not stabilized.

- Permeable paving is not ideal for high traffic/high speed areas because it has lower load-bearing capacity than conventional pavement.

Design Criteria

Permeable pavement should be designed according to the requirements listed in Table 6-11 and outlined in the section below.

Table 6-11: Permeable Pavements Design Criteria

Design Parameter	Unit	Design Criteria
Stormwater Quality Design Volume (SQDV)	acre-feet	See Section 2 and Appendix E for calculating SQDV.
Modular Porous Block Type		40% surface area open
Pretreatment	-	Runoff from pervious areas shall be minimized but, if provided, BIO-3: Vegetated Swale or BIO-4: Filter Strip shall be provided for all runoff from offsite sources that are not directly adjacent to the permeable pavement.
Drawdown time of gravel drainage layer	hrs	12 - 72
Porous Pavement Infill		ASTM C-33 sand or equivalent
Base courses		1-inch sand (ASTM C-33) over 1-inch gravel
Minimum depth to bedrock	ft	2 (without underdrains)
Minimum depth to seasonal high water table	ft	2 (with underdrains); 10 (without underdrains)
Infiltration rate of subsoil	in/hr	1.0 (minimum without an underdrain)
Underdrain	-	6 inch minimum diameter; 0.5% minimum slope
Perimeter wall width	Inches	6
Overflow device	-	Required

Geotechnical Considerations


An extensive geotechnical site investigation must be undertaken early in the site planning process to verify site suitability for the installation of infiltration facilities, due to the potential to contaminate groundwater, cause slope instability, impact surrounding structures, and have insufficient infiltration capacity. Soil infiltration rates and the water table depth should be evaluated to ensure that conditions are satisfactory for proper operation of an infiltration facility. See Appendix C for guidance on infiltration testing.

The project designer must demonstrate through infiltration testing, soil logs, and the written opinion of a licensed civil engineer that sufficiently permeable soils exist onsite to allow the construction of a properly functioning infiltration facility.

- 1) Infiltration facilities require a minimum native soil infiltration rate of 0.5 inches/hour. If infiltration rates exceed 2.4 inches/hour, then the runoff should be fully treated in an upstream BMP prior to infiltration to protect groundwater quality. Pretreatment for removing coarse sediment present in runoff from the tributary area is required in all instances.
- 2) Groundwater separation must be at least 5 feet from the basin bottom to the measured season high groundwater elevation or estimated high groundwater mounding elevation. Groundwater levels measurements must be made during the time when the water level is expected to be at a maximum (i.e., toward the end of the wet season).
- 3) Sites with a slope greater than 25% (4:1) shall be excluded. A geotechnical analysis and report addressing slope stability are required if located on slopes greater than 15%.

Soil Assessment and Site Geotechnical Investigation Reports

The soil assessment report should:

- State whether the site is suitable for the proposed permeable pavement; 
- Recommend a design infiltration rate (see the Step 2 of sizing methodology section, “Determine the design percolation rate,” in the Infiltration Basin fact sheet above);
- Identify the seasonal high depth to groundwater table surface elevation;
- Provide a good understanding of how the stormwater runoff will move in the soil (horizontally or vertically) and if there are any geological conditions that could inhibit the movement of water; and
- If a geotechnical investigation and report are required, the report should:
 - Provide a written opinion by a professional civil engineer describing whether the infiltration trench will compromise slope stability; and
 - Identify potential impacts to nearby structural foundations.

Setbacks

- 1) Infiltration facilities shall be setback a minimum of 100 feet from proposed or existing potable wells, non-potable wells, septic drain fields, and springs.

- 2) Infiltration BMPs must be sited at least 50 feet away from slopes steeper than 15 percent.
- 3) Infiltration BMPs must be setback from building foundations at least eight feet or have an alternative setback established by the geotechnical expert for the project.

Pretreatment

- 1) Depending on how and where permeable pavements will be used, pretreatment of the runoff entering the permeable pavement may be necessary. This is particularly important when the permeable pavement will be accepting run-on from pervious areas or areas that are not completely stabilized. If this is the case, then the run-on shall be treated prior to contacting the permeable pavement. Without adequate pretreatment, the life of the permeable pavement may be significantly decreased.
- 2) If sheet flow is conveyed to the permeable pavement over stabilized grassed areas, the site must be graded in such a way that minimizes erosive conditions.

Sizing Criteria

Permeable pavement must be designed to meet Ventura County codes and/or applicable City codes. These sizing criteria are meant to provide guidance for runoff volume storage only.

Step 1: Calculate the Design Volume

Infiltration facilities shall be sized to capture and infiltrate the SQDV volume (see [Section 2](#) and Appendix E) with a 12 to 72 hour drawdown time (see Appendix D, Section D.2).

Step 2: Determine the Design Percolation Rate

The percolation rate will decline between maintenance cycles as the surface becomes occluded and particulates accumulate in the infiltration layer. Monitoring of actual facility performance has shown that the full-scale infiltration rate is far lower than the rate measured by small-scale testing. It is important that adequate conservatism is incorporated in the selection of design percolation rates. For infiltration trenches, the design percolation rate discussed here is the percolation rate of the underlying soils and not the percolation rate of the filter media bed (refer to the “[Geometry and Sizing](#)” section of INF-2 for the recommended composition of the filter media bed for infiltration trenches).

Considerations for Design Percolation Rate Corrections

Suitability assessment related considerations include (Table 6-2):

- Soil assessment methods – the site assessment extent (e.g., number of borings, test pits, etc.) and the measurement method used to estimate the short-term infiltration rate.

- Predominant soil texture/percent fines – soil texture and the percent of fines can greatly influence the potential for clogging.
- Site soil variability – site with spatially heterogeneous soils (vertically or horizontally) as determined from site investigations are more difficult to estimate average properties resulting in a higher level of uncertainty associated with initial estimates.
- Depth to seasonal high groundwater/impervious layer – groundwater mounding may become an issue during excessively wet conditions where shallow aquifers or shallow clay lenses are present.

Table 6-12: Suitability Assessment Related Considerations for Infiltration Facility Safety Factors

Consideration	High Concern	Medium Concern	Low Concern
Assessment methods	Use of soil survey maps or simple texture analysis to estimate short-term infiltration rates	Direct measurement of ≥ 20 percent of infiltration area with localized infiltration measurement methods (e.g., infiltrometer)	Direct measurement of ≥ 50 percent of infiltration area with localized infiltration measurement methods or Use of extensive test pit infiltration measurement methods
Ventura Hydrology Manual soil number (measured infiltration rate)	3 ($f = 0.5 - 0.64$)	4 or 5 ($f = 0.65 - 0.91$)	6 or 7 ($f = 0.92$ or higher)
Site soil variability	Highly variable soils indicated from site assessment or limited soil borings collected during site assessment	Soil borings/test pits indicate moderately homogeneous soils	Multiple soil borings/test pits indicate relatively homogeneous soils
Depth to groundwater/impervious layer	<10 ft below facility bottom	10-30 ft below facility bottom	>30 below facility bottom

Localized infiltration testing refers to methods such as the double ring infiltrometer test (ASTM D3385-88) which measure infiltration rates over an area less than 10 sq-ft and

do not attempt to account for soil heterogeneity. Extensive infiltration testing refers to methods that include excavating a significant portion of the proposed infiltration area, filling the excavation with water, and monitoring drawdown. In all cases, testing should be conducted in the area of the proposed BMP where, based on geotechnical data, soils appear least likely to support infiltration.

Design related considerations include (Table 6-3):

- Size of area tributary to facility – all things being equal, both physical and economic risk factors related to infiltration facilities increase with an increase in the tributary area served. Therefore facilities serving larger tributary areas should use more restrictive adjustment factors.
- Level of pretreatment/expected influent sediment loads – credit should be given for good pretreatment by allowing less restrictive factors to account for the reduced probability of clogging from high sediment loading. Also facilities designed to capture runoff from relatively clean surfaces such as rooftops are likely to see low sediment loads and therefore should be allowed to apply less restrictive safety factors.
- Redundancy – facilities that consist of multiple subsystems operating in parallel such that parts of the system remains functional when other parts fail and/or bypass should be rewarded for the built-in redundancy with less restrictive correction and safety factors. For example, if bypass flows would be at least partially treated in another BMP, the risk of discharging untreated runoff in the event of clogging the primary facility is reduced. A bioretention facility that overflows to a landscaped area is another example.

Compaction during construction – proper construction oversight is needed during construction to ensure that the bottom of the infiltration facility are not overly compacted. Facilities that do not commit to proper construction practices and oversight should have to use more restrictive correction and safety factors.

Table 6-13: Design Related Considerations for Infiltration Facility Safety Factors

Consideration	High Concern	Medium Concern	Low Concern
Tributary area size	Greater than 10 acres.	Greater than 2 acres but less than 10 acres.	2 acres or less.
Level of pre-treatment/ expected influent sediment loads	Pre-treatment from gross solids removal devices only, such as hydrodynamic separators, racks and screens AND tributary area includes landscaped areas, steep slopes, high traffic areas, or any other areas expected to produce high sediment, trash, or debris loads.	Good pre-treatment with BMPs that mitigate coarse sediments such as vegetated swales AND influent sediment loads from the tributary area are expected to be relatively low (e.g., low traffic, mild slopes, disconnected impervious areas, etc.).	Excellent pre-treatment with BMPs that mitigate fine sediments such as bioretention or media filtration OR sedimentation or facility only treats runoff from relatively clean surfaces, such as rooftops.
Redundancy of treatment	No redundancy in BMP treatment train.	Medium redundancy, other BMPs available in treatment train to maintain at least 50% of function of facility in event of failure.	High redundancy, multiple components capable of operating independently and in parallel, maintaining at least 90% of facility functionality in event of failure.
Compaction during construction	Construction of facility on a compacted site or elevated probability of unintended/ indirect compaction.	Medium probability of unintended/ indirect compaction.	Heavy equipment actively prohibited from infiltration areas during construction and low probability of unintended/ indirect compaction.

Adjust the measured short-term infiltration rate using a weighted average of several safety factors, using the worksheet shown in Table 6-4 below. The design percolation rate would be determined as follows:

- For each consideration shown in Table 6-2 and Table 6-3 above, determine whether the consideration is a high, medium, or low concern.
- For all high concerns assign a factor value of 3, for medium concerns assign a factor value of 2, and for low concerns assign a factor value of 1.
- Multiply each of the factors by the corresponding weight to get a product.

- Sum the products within each factor category to obtain a safety factor for each.
- Multiply the two safety factors together to get the final combined safety factor. If the combined safety factor is less than 2, then use 2 as the safety factor.
- Divide the measured short term infiltration rate by the combined safety factor to obtain the adjusted design percolation rate for use in sizing the infiltration facility.

Table 6-14: Infiltration Facility Safety Factor Determination Worksheet

Factor Category		Factor Description	Assigned Weight (w)	Factor Value (v)	Product (p) p = w x v
A	Suitability Assessment	Soil assessment methods	0.25		
		Predominant soil texture	0.25		
		Site soil variability	0.25		
		Depth to groundwater / impervious layer	0.25		
		Suitability Assessment Safety Factor, S _A = Σp			
B	Design	Tributary area size	0.25		
		Level of pre-treatment/ expected sediment loads	0.25		
		Redundancy	0.25		
		Compaction during construction	0.25		
		Design Safety Factor, S _B = Σp			
Combined Safety Factor = S_A x S_B					

Note: The minimum combined adjustment factor shall not be less than 2.0 and the maximum combined adjustment factor shall not exceed 9.

Step 3: Determine the Gravel Drainage Layer Depth

Permeable pavement (including the base layers) shall be designed to drain in less than 72 hours. The basis for this is that soils must be allowed to dry out periodically in order to restore hydraulic capacity to receive flows from subsequent storms, maintain infiltration rates, maintain adequate sub soil oxygen levels for healthy soil biota, and to provide proper soil conditions for biodegradation and retention of pollutants.

- 1) Calculate the maximum depth of runoff (d_{max}) that can be infiltrated within the drawdown time:

$$d_{max} = \frac{P_{design} \cdot t}{12} \tag{Equation 6-11}$$

Where:

d_{max} = maximum depth that can be infiltrated (ft)

P_{design} = design percolation rate of underlying soils (in/hr) (see Step 2, above)

t = drawdown time (12-72 hours) (hr)

2) Select the gravel drainage layer depth, (l), such that:

$$d_{max} \geq n \times l \quad \text{(Equation 6-12)}$$

Where:

d_{max} = maximum depth that can be infiltrated (ft) (see 1) above)

n = gravel drainage layer porosity(unitless)(generally about 32% or 0.32 for gravel)

l = gravel drainage layer depth (ft)

Step 4: Determine infiltrating surface area

3) Calculate infiltrating surface area for permeable pavement (A):

$$A = \frac{SQDV}{\frac{TP_{design}}{12} + nl} \quad \text{(Equation 6-13)}$$

Where:

P_{design} = design percolation rate of underlying soils (in/hr) (see Step 2, above)

n = gravel drainage layer porosity(unitless)[about 32% or 0.32 for gravel]

l = depth of gravel drainage layer (ft)

T = time to fill the gravel drainage layer with water (use 2 hours for most designs) (hr)

Geometry and Size

1) Permeable pavement shall be sized to capture and treat the stormwater quality design volume (SQDV).

2) Pavement design options include:

a. Full or partial infiltration – A design for full infiltration uses an open graded base for maximum infiltration and storage of stormwater. The water infiltrates directly into the base and through the soil. Pipes provide drainage

in overflow conditions. Partial infiltration does not rely completely on infiltration through the soil to dispose all of the captured runoff. Some of the water may infiltrate into the soil and the remainder drained by pipes.

- b. No infiltration – No infiltration is desirable when the soil has low permeability and low strength, or there are other site limitations. An underdrain should be provided if the depth to bedrock is less than 2 feet or the depth to the water table is less than 10 feet. By storing water for a time in the base and then slowly releasing it through pipes, the design behaves like an underground detention pond. In other cases, the soil of the sub-base may be compacted and stabilized to render improved support for vehicular loads. This practice reduces infiltration into the soil to nearly zero. The “no infiltration” option requires the use of geotextile and bedding between the pavement and the open graded base.
- 3) If permeable pavement is located on a site with a slope greater than 2%, the permeable pavement area shall be terraced to prevent lateral flow through the subsurface. Permeable pavement cannot be located on a site with a slope greater than 5%.
 - 4) Porous pavement systems generally consist of at least four different layers of material:
 - a. The top or wearing layer consists of either asphalt or concrete with a greater than normal percentage of voids (typically 12 to 20 percent in the case of asphalt). The wearing layer may also be comprised of lattice-type pavers (either hollow concrete blocks or paving stones made from solid conventional concrete or stone), which are set in a bedding material (sand, pea-sized gravel or turf grass).
 - b. Below the wearing layer, a stone reservoir layer or a thick layer of aggregate (e.g., 2 inch stone) provides the bulk of the water storage capacity for a porous pavement system. In the pavement design, it is important to ensure that this reservoir layer retains its load bearing capacity under saturated conditions, because it may take several days for complete drainage to occur.
 - c. Typically, porous pavement designs include two (or more) transition layers that can be constructed from 1 to 2 inch diameter stone. One transition layer separates the top wearing layer from the underlying stone reservoir layer. Another transition layer is used to separate the stone reservoir from the undisturbed subgrade soil. Some designs also add a geotextile layer to this bottom layer or some combination of stones and geotextiles.
 - d. Porous asphalt pavement, for example, consists of open grade asphalt mixture ranging in depth from 2 to 4 inches with 16 percent voids. The thickness selected depends on bearing strength and pavement design requirements. This layer sits on a 2 to 4 inch transition layer located over a

stone reservoir. The bottom layer completes the transition to the underlying undisturbed soil using a combination transition/filter fabric layer.

- e. The depth of each layer shall be determined by a licensed civil engineer based on analyses of the hydrology, hydraulics, and structural requirements of the site.
- 5) Modular paving stones are also used to create porous pavements. These pavements can be constructed in situ by pouring concrete into special frames or by using preformed blocks. The top layer of these porous pavements consists of conventional concrete, with the intervening void areas filled with either turf or sand. A transition or bedding layer is used to make the transition to the reservoir layer. These lattice-type pavers or hollow concrete blocks are often used in conjunction with turf grasses and are used in low-traffic parking lots, lanes, or driveways. Porous pavements using paving stones have similar construction, but can be designed to have a much higher load bearing capacity, and therefore have more widespread applicability. Construction guidelines and design specifications are available from the manufacturers of these products.
- 6) Permeable pavement (including the base layers) shall be designed to drain in less than 72 hours. The basis for this is that soils must be allowed to dry out periodically in order to restore hydraulic capacity to receive flows from subsequent storms, maintain infiltration rates, maintain adequate subsoil oxygen levels for healthy soil biota, and to provide proper soil conditions for biodegradation and retention of pollutants.
- 7) The percolation rate will decline as the surface becomes occluded and particulates accumulate in the infiltration layer. It is important that adequate conservatism is incorporated in the selection of design percolation rates.

Overflow

An overflow mechanism is required. Two options are provided:

Option 1: Perimeter control

Flows in excess of the design capacity of the permeable pavement system will require an overflow system connected to a downstream conveyance or other stormwater runoff BMP. In addition, if the pavement becomes clogged and infiltration decreases to the point that there is ponding, runoff will migrate off of the pavement via overland flow instead of infiltrating into the subsurface gravel layer. There are several options for handling overflow using perimeter controls such as:

- 1) Perimeter vegetated swale.
- 2) Perimeter bioretention.
- 3) Storm drain inlets.

- 4) Rock filled trench that funnels flow around pavement and into the subsurface gravel layer.

Option 2: Overflow pipe(s)

- 1) A vertical pipe shall be connected to the underdrain.
- 2) The diameter, location, and quantity may vary with design and shall be determined by a licensed civil engineer.
- 3) The pipe shall be located away from vehicular traffic.
- 4) The piping system may incorporate an observational and/or cleanout well.
- 5) The top of the overflow pipe shall be covered with a screen fastened over the overflow inlet.

Construction Considerations

- 1) Permeable pavement shall be laid close to level and the bottom of the base layers must be level to ensure uniform infiltration.
- 2) Permeable pavement surfaces shall not be used to store site materials, unless the surface is well protected from accidental spillage or other contamination.
- 3) To prevent/minimize soil compaction in the area of the permeable pavement installation, use light equipment with tracks or oversized tires.
- 4) Divert stormwater from the area as needed (before and during installation).
- 5) The pavement shall be the last installation done at a development site. Landscaping shall be completed and adjacent areas stabilized, before pavement installation to minimize the risk of clogging.
- 6) Vehicular traffic shall be prohibited for at least 2 days after installation.

Operations and Maintenance

Permeable pavement mainly requires vacuuming and management of adjacent areas to limit sediment contamination and prevent clogging by fine sediment particles. Therefore, little special training is needed for maintenance crews. The following maintenance concerns and maintenance activities shall be considered and provided:

- 1) Trash tends to accumulate in paved areas, particularly in parking lots and along roadways. The need for litter removal shall be determined through periodic inspection.
- 2) Regularly (e.g., monthly for a few months after initial installation, then quarterly) inspect pavement for pools of standing water after rain events, this could indicate surface clogging.

- 3) Actively (3 to 4 times per year, or more frequently depending onsite conditions) vacuum sweep the pavement to reduce the risk of clogging by frequently removing fine sediments before they can clog the pavement and subsurface layers. This also helps to prolong the functional period of the pavement.
- 4) Inspect for vegetation growth on pavement and remove when present.
- 5) Inspect for missing sand/gravel in spaces between pavers and replace as needed.
- 6) Activities that lead to ruts or depressions on the surface shall be prevented or the integrity of the pavement shall be restored by patching or repaving. Examples are vehicle tracks and utility maintenance.
- 7) Spot clogging of porous concrete may be remedied by drilling 0.5 inch holes every few feet in the concrete.
- 8) Interlocking pavers that are damaged shall be replaced.
- 9) Maintain landscaped areas and reseed bare areas.

INF-6: Proprietary Infiltration

A number of vendors offer proprietary infiltration products that allow for similar or enhanced rates of infiltration and subsurface storage while offering durable prefabricated structures. There are many varieties of proprietary infiltration BMPs.



Proprietary Infiltration BMP Installation

Photo Credits: 1. Contech Stormwater Solutions, Inc.; 2. StormTrap

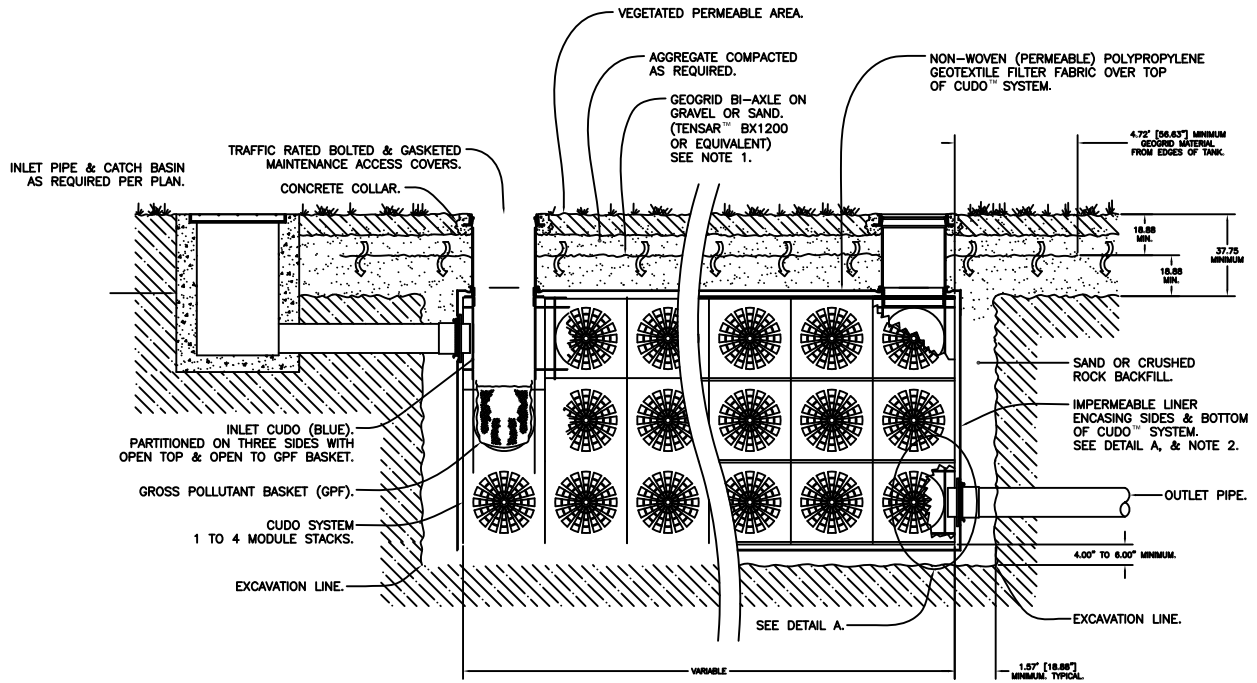
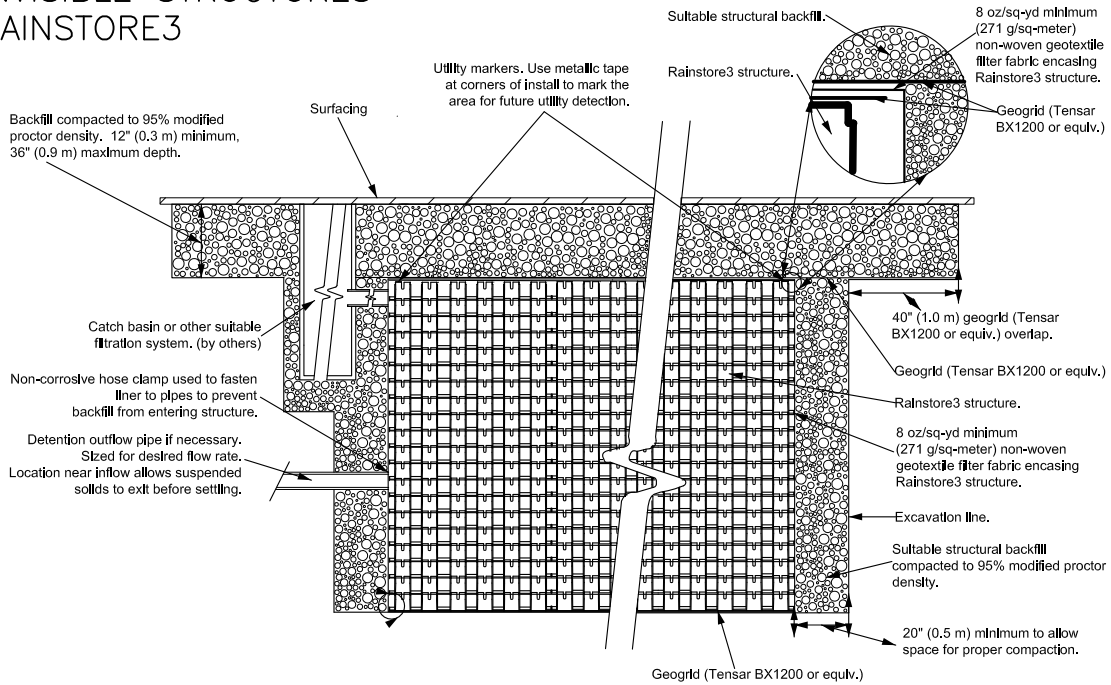
Application

- Mixed-use and commercial
- Roads and parking lots
- Parks and open spaces
- Single and multi-family residential

Routine Maintenance

- Removal trash, debris, and sediment at inlet and outlets
- Wet weather inspection to ensure drain time
- Inspect for mosquito breeding

INVISIBLE STRUCTURES RAINSTORE3



CUDO Stormwater Products, Inc.
P.O. Box 497 Occidental, CA 95465
Ph. (877) 876-3345 Fax (707) 876-3346



Figure 6-7: Proprietary Infiltration BMPs

Limitations

The following limitations shall be considered before choosing to use an infiltration BMP:

- Native soil infiltration rate - soil permeability of the infiltration basin location must be at least 0.5 inches per hour.
- Depth to groundwater, bedrock, or low permeability soil layer – 5 feet vertical separation is required between the bottom of the infiltration basin and the seasonal high groundwater level or mounded groundwater level, bedrock, or other barrier to infiltration to ensure that the facility will completely drain between storms and that infiltrating water will receive adequate treatment through the soils before it reaches the groundwater.
- Slope stability - infiltration BMPs must be sited at least 50 feet away from slopes steeper than 15 percent.
- Setbacks - a minimum setback (100 feet or more) must be provided between infiltration BMPs and potable wells, non-potable wells, drain fields and springs. Infiltration BMPs must be setback from building foundations at least eight feet or have an alternative setback established by the geotechnical expert for the project.
- Groundwater contamination - the application of infiltration BMPs should include significant pretreatment in an area identified as an unconfined aquifer, to ensure groundwater is protected for pollutants of concern.
- Contaminated soils or groundwater plumes - infiltration BMPs are not allowed at locations with contaminated soils or groundwater where the pollutants could be mobilized or exacerbated by infiltration, unless a site-specific analysis determines the infiltration would be beneficial.
- High pollutant land uses - infiltration BMPs should not be placed in high-risk areas such as at or near service/gas stations, truck stops, and heavy industrial sites due to the groundwater contamination risk unless a site-specific evaluation demonstrates that sufficient pretreatment is provided to address pollutants of concern, high risks areas are isolated from stormwater runoff, or infiltration areas have little chance of spill migration
- High sediment loading rates – infiltration BMPs may clog quickly if sediment loads are high (e.g., unstabilized site) or if flows are not adequately pretreated.

Table 6-15: Proprietary Infiltration Manufacturer Websites

Device	Manufacturer	Website
A-2000™	Contech® Construction Products Inc.	www.contech-cpi.com/stormwater/13
ChamberMaxx™	Contech® Construction Products Inc.	www.contech-cpi.com/stormwater/13
CON/SPAN Vaults™	Contech® Construction Products Inc.	www.contech-cpi.com/stormwater/13
CON/Storm™	Contech® Construction Products Inc.	www.contech-cpi.com/stormwater/13
CUDO® Water Storage System	KriStar Enterprises Inc.	www.kristar.com
D-Raintank® Matrix Tank Modules	Atlantis®	www.atlantis-america.com
EcoRain™ Modular Rain Tank	EcoRain Systems Inc.	www.ecorain.com
Landmax®	Hancor®	www.hancor.com
Landsaver™	Hancor®	www.hancor.com
Precast Concrete Dry Well	Jensen Precast®	www.jensenprecast.com
Rainstore ³	Invisible Structures Inc.	www.invisiblestructures.com
StormChambers™	Hydrologic Solutions, Inc.	www.hydrologicsolutions.com
Stormtech® SC-740 and SC-310 Chambers	StormTech LLC	www.stormtech.com
StormTrap®	StormTrap	www.stormtrap.com
Triton Chambers™	Triton Stormwater Solutions	www.tritonsws.com

Geotechnical Considerations

An extensive geotechnical site investigation must be undertaken early in the site planning process to verify site suitability for the installation of infiltration facilities, due to the potential to contaminate groundwater, cause slope instability, impact surrounding structures, and have insufficient infiltration capacity. Soil infiltration rates and the water table depth should be evaluated to ensure that conditions are satisfactory for proper operation of an infiltration facility. See Appendix C for guidance on infiltration testing.

The project designer must demonstrate through infiltration testing, soil logs, and the written opinion of a licensed civil engineer that sufficiently permeable soils exist onsite to allow the construction of a properly functioning infiltration facility.

- 1) Infiltration facilities require a minimum soil infiltration rate of 0.5 inches/hour. If infiltration rates exceed 2.4 inches/hour, then the runoff should be fully treated in an upstream BMP prior to infiltration to protect groundwater quality. Pretreatment for coarse sediment removal is required in all instances.

- 2) Groundwater separation must be at least 5 feet from the basin bottom to the measured season high groundwater elevation or estimated high groundwater mounding elevation. Measurements of groundwater levels must be made during the time when water level is expected to be at a maximum (i.e., toward the end of the wet season).
- 3) Sites with a slope greater than 25% (4:1) shall be excluded. A geotechnical analysis and report addressing slope stability are required if located on slopes greater than 15%.

Soil Assessment and Site Geotechnical Investigation Reports

The soil assessment report should:

- State whether the site is suitable for the proposed proprietary infiltration BMP.;
- Recommend a design infiltration rate (see the Step 2 of sizing methodology section, “Determine the design percolation rate,” in the Infiltration Basin fact sheet above);
- Identify the seasonal high depth to groundwater table surface elevation;
- Provide a good understanding of how the stormwater runoff will move in the soil (horizontally or vertically) and if there are any geological conditions that could inhibit the movement of water; and
- If a geotechnical investigation and report are required, the report should:
 - Provide a written opinion by a professional civil engineer describing whether the infiltration trench will compromise slope stability; and
 - Identify potential impacts to nearby structural foundations.

Setbacks

- 1) Infiltration facilities shall be setback a minimum of 100 feet from proposed or existing potable wells, non-potable wells, septic drain fields, and springs.
- 2) Infiltration BMPs must be sited at least 50 feet away from slopes steeper than 15 percent.
- 3) Infiltration BMPs must be setback from building foundations at least eight feet or have an alternative setback established by the geotechnical expert for the project.

Pretreatment

Pretreatment is required for proprietary infiltration BMPs in order to reduce the sediment load entering the facility and maintain the infiltration rate of the facility. Pretreatment refers to design features that provide settling of sediment particles before

runoff reaches a management practice. This eases the long-term maintenance burden and likelihood of failure. Pretreatment is important for most stormwater treatment BMPs, but it is particularly important for infiltration BMPs. To ensure that pretreatment mechanisms are effective, designers shall incorporate sediment reduction practices. Sediment reduction BMPs may include vegetated swales, vegetated filter strips, sedimentation basins, sedimentation manholes and hydrodynamic separation devices. The use of at least two pretreatment devices is highly recommended for infiltration BMPs.

Sizing

- 1) Proprietary infiltration BMPs shall be sized to capture and treat the stormwater quality design volume (SQDV). See Section 2 and Appendix E for calculating for further detail.
- 2) The percolation rate will decline as the surface becomes occluded and particulates accumulate in the infiltrative layer. It is important that adequate conservatism is incorporated in the selection of design percolation rates.
- 3) For the sizing guidelines, refer to the manufacturer's website.

Operations and Maintenance

See vendor's website for maintenance requirements.

RWH-1: Cistern

Cisterns are large rain barrels and one type of rainwater harvesting (RWH) BMP. While rain barrels are less than 100 gallons, cisterns range from 100 to 10,000 gallons in capacity. Cisterns collect and temporarily store runoff from rooftops for later use as irrigation and/or other non-potable uses. The following components are required for installing and utilizing a cistern: (1) pipes that divert rooftop runoff to the cistern, (2) an overflow for when the cistern is full, (3) a pump, and (4) a distribution system to get the water to where it is intended to be used.



Cistern

Photo Credit: MetaEfficient

Application

- Any type of land use, provided adequate water demand
- Collect rooftop runoff

Preventative Maintenance

- Trash removal
- After-rain inspections
- Sediment removal

Limitations

The following describes site suitability recommendations for cisterns.

- Cisterns shall not be located on uneven or sloped surfaces.
- If installed on a sloped surface, the base where the cistern will be installed shall be leveled prior to installation.
- Cisterns shall be secured in place.

Design Criteria

The effectiveness of rainwater harvesting (RWH) systems is a function of tributary area, storage volume, demand patterns and magnitudes, and operational regime. If either of the latter two factors are too complex, simple design criteria metrics are not possible. Thus, the cistern design criteria provided in this Fact Sheet are intended for the evaluation of systems that have relatively simple demand regimes and passive operations. If the answer to any of the following complexity screening questions is yes, a site-specific evaluation of rainwater harvesting effectiveness should be completed using a continuous simulation model with a long-term precipitation record.

Complexity Screening Questions:

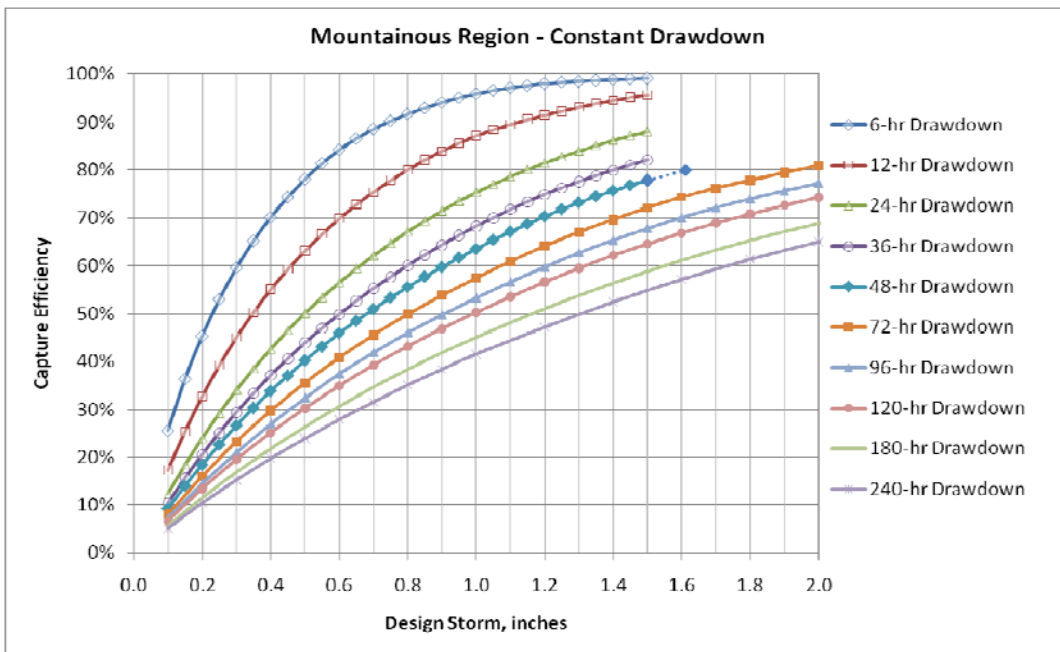
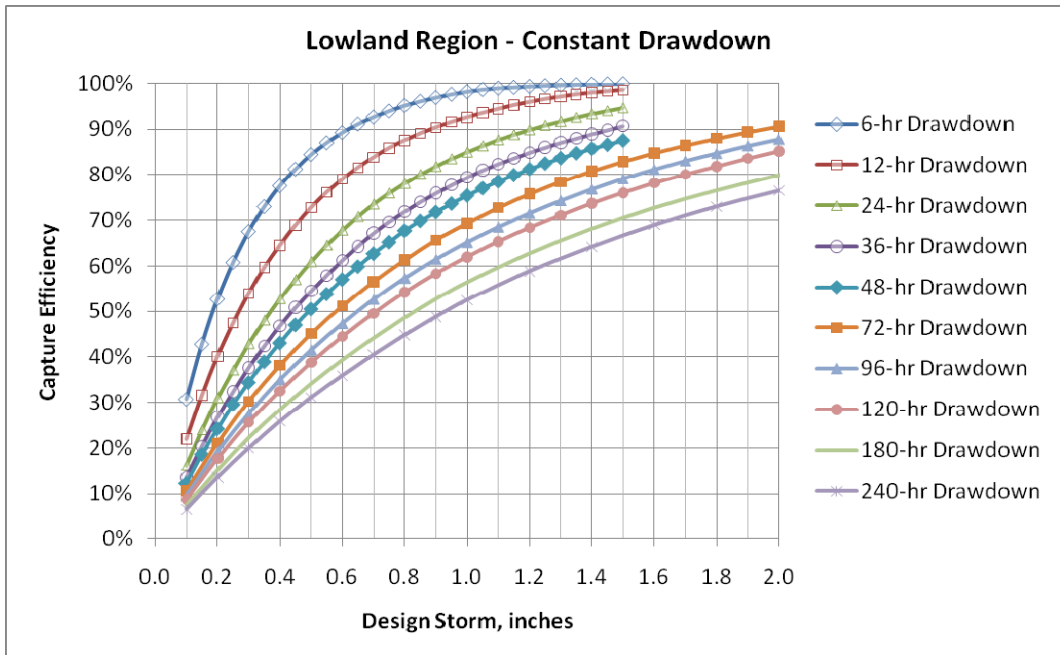
- Does the proposed system have seasonally-varying demand other than irrigation?
- Will the system be operated by advanced control systems or otherwise actively controlled?
- Does the operational regime call for the system be shut down at any time during the rainy season?



- The effectiveness of a cistern for retaining the SQDV depends on the cistern's effective storage capacity (i.e., the volume available for storage at the beginning of each event). Therefore, the required size for a cistern varies based on precipitation and demand.

Using the following sizing charts, cisterns shall be sized to achieve 80 percent capture efficiency. These nomographs are based on continuous simulation performed in EPA SWMM using precipitation and ET records representative of lowland regions (Oxnard Airport Precipitation Gauge, El Rio Spreading Grounds ET station) and mountainous regions (Ojai-Stewart Canyon Precipitation Gauge, Matilja ET Station) of the County.





Using Captured Water Use for Landscape Irrigation

- Collect stormwater runoff from roofs in correctly sized cisterns.
- Collect stormwater runoff along ground surfaces in underground detention/retention basins.
- Roof-collected stormwater can be used for landscaping.
- Plumbing systems shall be installed in accordance with the current California Building Code and Plumbing Code (CBC – part of California Code of Regulations, Title 24).

Construction Considerations

The foundation housing the cistern must be adequate to support the weight of the cistern and the water it will store.

Operations and Maintenance

- 1) Inspect cisterns, associated pipes, and valve connections for leaks.
- 2) Clean gutters and filters of debris that has accumulated and is obstructing flow into the cistern.
- 3) Clean and remove accumulated sediment annually.
- 4) Check cistern for stability and anchor if necessary.
- 5) Slopes in the vicinity of the cistern shall be stabilized and planted using appropriate erosion control measures when native soil is exposed or erosion channels are forming.
- 6) The cistern shall be well maintained; trash and debris, sediment, visual contamination (e.g., oils), and noxious or nuisance weeds shall all be removed.
- 7) If the cistern is underground, ensure that a manhole is accessible, operational, and secure.

ET-1: Green Roof

Green roofs (also known as eco-roofs and vegetated roof covers) are roofing systems that layer a soil/vegetative cover over a waterproofing membrane. Green roofs rely on highly porous media and moisture retention layers to store intercepted precipitation and to support vegetation that can reduce the volume of stormwater runoff via evapotranspiration. There are two types of green roofing systems: extensive, which is a light-weight system; and intensive, which is a heavier system that allows for larger plants but requires additional structural support.



Green Roof Examples

Photo Credits:

- 1. Milwaukee Department of Environmental Sustainability;*
- 2. Geosyntec Consultants*

Application

- Building roofs
- Outdoor eating area roofs
- Parking structure or turnaround roofs

Preventative Maintenance

- Weeding and pruning
- Leaf and debris removal
- Regular membrane inspection
- Drain cleanout

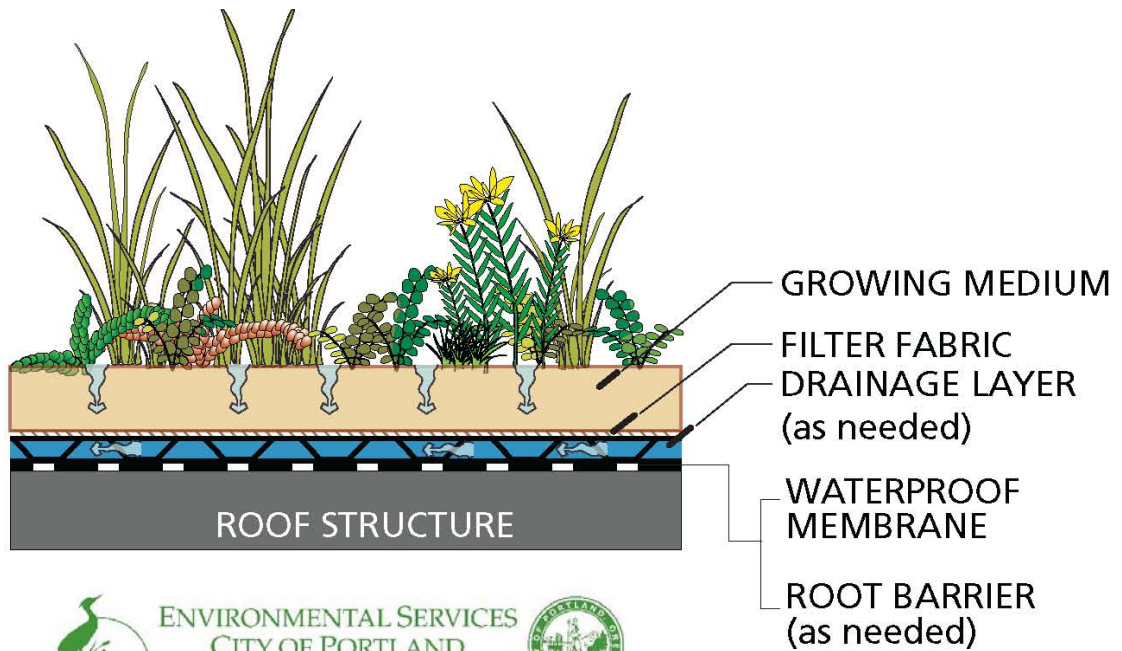


Exhibit A: Green Roof Schematic Courtesy of Portland, OR Environmental Services Department

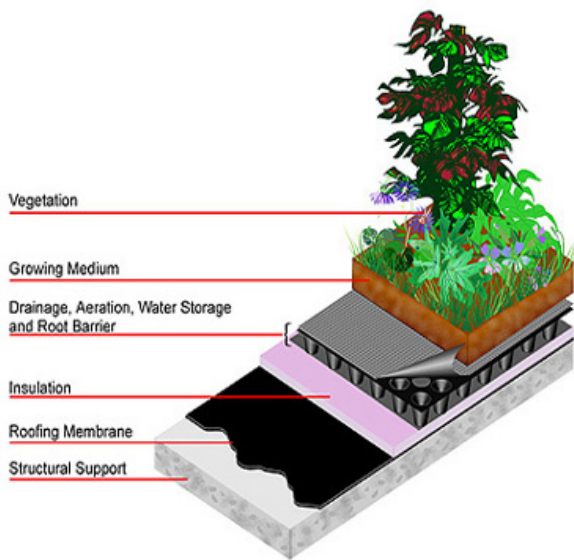


Exhibit B: Green Roof Schematic Courtesy of American Wick



Figure 6-8: Green Roofs

Limitations

The following describes additional site suitability recommendations and limitations for green roofs.

- Typically not used for steep roofs (>25%); and
- Structural roof support must be sufficient to support additional roof weight.

Design Criteria

Green roofs should be designed according to the requirements listed in Table 6-16 and outlined in the section below.

Table 6-16: Green Roof Design Criteria

Design Parameter	Unit	Design Criteria
Soil depth range	inch	2 – 6
Saturated soil weight	lbs. / sq. ft.	10 – 25
Maximum roof slope	%	25
Minimum roof slope	--	Flat
Vegetation type	--	Varies (see vegetation section below)
Vegetation height	--	Varies (see vegetation section below)

Sizing

Green roofs do provide quantifiable reduction in volume. However, they are not explicitly sized to meet the water quality treatment requirements. Rather, the volume reduction is accounted for implicitly in sizing calculations for the treatment BMPs for the remainder of the site by assuming that the roof area is pervious rather than impervious when calculating a runoff coefficient for the site.

Green Roof Components

Structural Support

The first requirement that must be met before installing a green roof is the structural support of the roof. The roof must be able to support the additional weight of the soil, water, and vegetation. A licensed structural engineer should be consulted to determine the proposed structural support during the design phase.

Waterproof Roofing Membrane

Waterproof roofing membrane is an integral part of a green roofing system. The waterproof membrane prevents the roof runoff from penetrating and damaging the roofing material. There are many materials available for this purpose and come in various forms (i.e., rolls, sheets, liquid) and exhibit different characteristics (e.g., flexibility, strength, etc.). Depending on the type of membrane chosen a root barrier may be required to prevent roots from compromising the integrity of the membrane.

Drainage Layer

Depending on the design of the roof, a drainage layer may be required to convey the excess runoff from of the roof. If a drainage layer is needed, there are numerous options including a gravel layer (which may require additional structural support), and many styles and types of plastic drainage layers.

Soil Considerations

The soil layer is an important factor in the construction and operation of green roofs. The soil layer must have excellent drainage, not be too heavy when saturated, and be adequately fertile as a growing medium for plants. Many companies sell their own proprietary soil mixes. However, a simple mix of $\frac{1}{4}$ topsoil, $\frac{1}{4}$ compost, and the remainder pumice perlite may be used for many applications. Other soil amendments may be substituted for the compost and the pumice perlite. The soil mix used should not contain any clay.

Vegetation

Green roofs must be vegetated in order to provide adequate treatment of runoff via filtration and evapotranspiration. Vegetation, when chosen and maintained appropriately, also improves the aesthetics of a site. Green roofs should be vegetated with a mix of erosion-resistant plant species that effectively bind the soil and can withstand the extreme environment of rooftops. A diverse selection of low growing plants that thrive under the specific site, climatic, and watering conditions should be identified. A mixture of drought-tolerant, self-sustaining (perennial or self-sowing without need for fertilizers, herbicides, and or pesticides) is most effective in the Ventura County region. Plants selected should also be low maintenance and able to withstand heat, cold, and high winds. Native or adapted sedum/succulent plants are preferred because they generally require less fertilizer, limited maintenance, and are more drought resistant than exotic plants. When appropriate, green roofs may be planted with larger plants. However, this depends on structural support and soil depth.

The following provides additional vegetation guidance for green roofs.

- 1) For extensive roofs, trees or shrubs may be used as long as the increased soil depth required may be supported.

- 2) Irrigation is required if the seed is planted in spring or summer. The use of a permanent smart (self-regulating) irrigation system or other watering system, may help provide maximal water quality performance. Drought-tolerant plants should be specified to minimize irrigation requirements. For projects seeking “High Performance Building” recognition, ASHRAE Standard 189.1 states that potable water cannot be used for irrigating green roofs after they are established.
- 3) Locate the green roof vegetation in an area without excessive shade to avoid poor vegetative growth. For moderately shaded areas, shade tolerant plants should be used.
- 4) A relevant plant list should be provided by a landscape professional and used as a guide to support project-specific planting recommendations, including recommendations on appropriate plants, fertilizer, mulching applications, and irrigation requirements (if any) to ensure healthy vegetation growth.

Drain

- 1) There must be a drain pipe (gutter) to convey runoff (both overflow and underdrain flow, if appropriate) safely from the roof to another basic or stormwater runoff BMP, a pervious area, or the stormwater conveyance system.

Construction Considerations

- 1) Building structure must be adequate to hold the additional weight of the soil, retained water, and plants.
- 2) Plants should be selected carefully to minimize maintenance and function properly.

Operations and Maintenance

- 1) During the establishment period, green roofs may need irrigation and occasional light fertilization until the plants have fully established themselves. Once healthy and fully established, properly selected climate-appropriate plants will no longer need irrigation except during extreme drought.
- 2) Weeding during the establishment period may be required to ensure proper establishment of the desired vegetation. Once established and assuming proper selection of vegetation, the vegetation shall not require any preventative maintenance.
- 3) The roofing membrane must be inspected routinely, as it is a crucial element of the green roof. In addition, preventative inspection of the drainage paths is required to ensure that there are no clogs in the system. If a green roof is not properly draining, the moisture in the system may cause the roof to leak and/or the plants to drown or rot. Leaks in the roof may occur not only due to improper drainage, but also if the incorrect combination of waterproofing barrier, root barrier, and drainage systems

- are selected. Leak inspections in the roofing system are advised, especially in locations prone to leaks, such as at all joints.
- 4) Inspect green roofs for erosion or damage to vegetation after every storm greater than 0.75 inches and at the end of the wet season to schedule summer maintenance and in the fall to ensure readiness for winter. Additional inspection after periods of heavy runoff is recommended. Green roofs should be checked for debris, litter, and signs of clogging.
 - 5) Replanting and/or reseeding of vegetation may be required for reestablishment.
 - 6) Vegetation shall be healthy and dense enough to provide filtering while protecting underlying soils from erosion.
 - 7) Fallen leaves and debris from deciduous plant foliage shall be removed.
 - 8) Invasive vegetation, such as Alligatorweed (*Alternanthera philoxeroides*), Halogeton (*Halogeton glomeratus*), Spotted Knapweed (*Centaurea maculosa*), Giant Reed (*Arundo donax*), Castor Bean (*Ricinus communis*), Perennial Pepperweed (*Lepidium latifolium*), and Yellow Starthistle (*Centaurea solstitialis*) must be removed and replaced with non-invasive species. For more information on invasive weeds, including biology and control of listed weeds, look at the encyclopedias located at the California Department of Food and Agriculture website or the California Invasive Plant Council website at www.cal-ipc.org.
 - 9) Dead vegetation shall be removed if greater than 10% of the area coverage. Vegetation shall be replaced and established before the wet season to maintain cover density and control erosion where soils are exposed.

ET-2: Hydrologic Source Control BMPs

Hydrologic source control (HSC) BMPs are simple BMPs that are highly integrated with the site design to reduce runoff volume. The practices described in this fact sheet include impervious area dispersion, street trees, and rain barrels.



Application

- Building roofs
- Sidewalks and patios
- Landscaping hardscapes

Preventative Maintenance

- Weeding and pruning
- Leaf and debris removal



Hydrologic Source Control Examples

Photo Credits:

1.

<http://www.auburn.edu/projects/sustainability/website/newsletter/0910.php>;

2. Geosyntec Consultants;

Accounting for Hydrologic Source Controls in Hydrologic Calculations

The effects of HSC BMPs are accounted for in hydrologic calculations as an adjustment to the storm depth used in the SQDV calculations described in [Section 2](#). Runoff volume calculations are performed exactly as described in Section 2, with the exception that the storm depth used in the calculation is adjusted prior to the calculation. Adjustments are based on the type and magnitude of HSC BMPs employed for the drainage area per guidance outlined in this Fact Sheet.

EXAMPLE 6.1: ACCOUNTING FOR HSCS IN HYDROLOGIC CALCULATIONS

Given:

- A drainage area consists of a 1 acre building roof surrounded by 0.25 acres of landscaping (80 percent composite imperviousness);
- The drainage from the roof is spread uniformly over the entire pervious area via splash pads and level spreaders;
- Soils are moderately well drained and have a shallow slope;
- For the purpose of this example, assume the hydrologic source control adjustment for this configuration of disconnected downspouts is 0.3 inches. For an actual project, hydrologic source control adjustment would be calculated based on instructions in this section; and
- The unadjusted design storm depth at the project site is 0.75 inches.

Result:

- 1) The designer uses 0.75 inches – 0.3 inches = 0.45 inches in the calculation of SQDV.

Impervious Area Dispersion

Impervious area dispersion refers to the practice of routing runoff from impervious areas, such as rooftops, walkways, and patios, onto the surface of adjacent pervious areas. Runoff is dispersed uniformly via splash block or dispersion trench and soaks into the ground as it moves slowly across the surface of the pervious area. Minor ponding may occur, but it is not the intent of this practice to actively promote localized on-lot infiltration, which should be designed as an infiltration BMP (see INF-1 through INF-6 above).

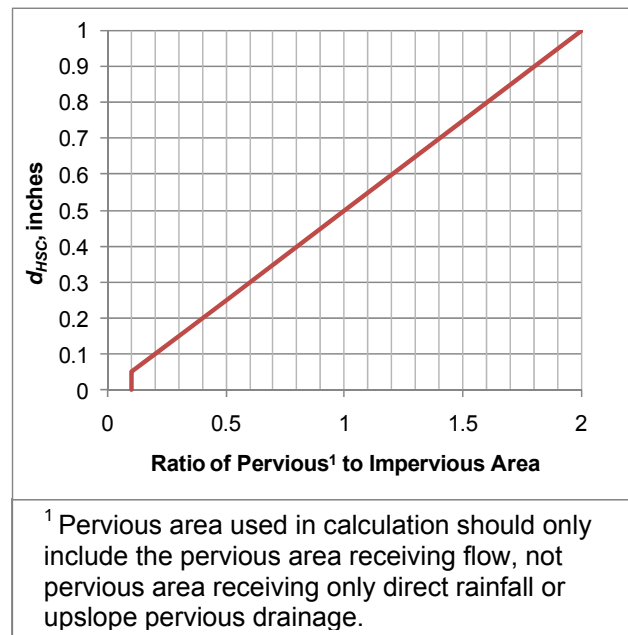
Design Considerations

- 1) Not likely to result in net increased infiltration over existing condition for previously pervious sites, but has potential to result in some geotechnical hazards associated with infiltration.
- 2) Significant pervious area should be available, at a ratio of at least 1 part pervious area capable of receiving flow to 5 parts impervious.

- 3) Pervious area receiving flow should have a slope ≤ 2 percent and path lengths of ≥ 10 feet per 1000 sf of impervious area.
- 4) Overflow from the pervious area up to the SQDV should be directed to a Retention BMP, Biofiltration BMP, or Treatment Control Measure. Larger flows should be directed to the storm drain system.
- 5) Soils in the pervious area should be preserved in their natural condition or improved with soil amendments (see Soil Amendments below).
- 6) Impervious area disconnection is an HSC that may be used as the first element in any treatment train.
- 7) The use of impervious area disconnection reduces the sizing requirement for downstream Retention BMPs, Biofiltration BMPs, and/or Treatment Control Measures.

Calculating HSC Retention Volume

- 1) The retention volume provided by downspout dispersion is a function of the ratio of impervious to pervious area.
- 2) Determine flow patterns in pervious area and estimate footprint of pervious area receiving dispersed flow. Calculate the ratio of pervious to impervious area.
- 3) Check soil conditions using the checklist below; amend if necessary.
- 4) Look up the storm retention depth (d_{HSC}), from the chart to the right.



- 5) The max d_{HSC} is equal to the design storm depth for the project site.

Soil Condition Checklist

- 1) Soil must have a maximum slope of 2 percent.
- 2) Landscaping must be well-established.
- 3) Amended soils shall consist of: 60 to 70% sand, 15 to 25% compost, 10 to 20% clean topsoil. The organic content of the soil mixture should be 8 to 12%; the pH range should be 5.5 to 7.5.

Additional References

- SMC LID Manual (pp 131):
http://www.lowimpactdevelopment.org/guest75/pub/All_Projects/SoCal_LID_Manual/SoCalLID_Manual_FINAL_040910.pdf
- City of Portland Bureau of Environmental Services. 2010. How to manage stormwater – Disconnect Downspouts:
<http://www.portlandonline.com/bes/index.cfm?c=43081&a=177702>
- Seattle Public Utility:
http://www.cityofseattle.org/util/stellent/groups/public/@spu/@usm/documents/webcontent/spu01_006395.pdf
- Thurston County, Washington State (pp 10):
http://www.co.thurston.wa.us/wwm/Engineering_Standards/Drainage_Manual/PDFs/DG-5%20Roof%20Runoff%20Control.pdf

Amended Soils

A soil amendment is any material added to a soil to improve its physical properties, such as the water retention, permeability, water infiltration, drainage, aeration and structure. The goal is to provide a better environment for roots. To do its work, an amendment must be thoroughly mixed into the soil. If it is merely buried, its effectiveness is reduced and it will interfere with water and air movement and root growth.

Amending a soil is different from mulching, although many mulches also are used as amendments. A mulch is left on the soil surface. Its purpose is to reduce evaporation and runoff, inhibit weed growth, and create an attractive appearance. Mulches also moderate soil temperature, helping to warm soils in the spring and cool them in the summer. Mulches may be incorporated into the soil as amendments after they have decomposed to the point that they no longer serve their purpose.

Organic amendments, such as compost, increase soil organic matter content and offer many benefits. Organic matter improves soil aeration, water infiltration, and both water- and nutrient-holding capacity. Many organic amendments contain plant nutrients and act as organic fertilizers. Organic matter also is an important energy source for bacteria, fungi and earthworms that live in the soil.

Design Considerations

- 1) Landscaped and other developed pervious areas can be amended to improve ET.
- 2) Soil amendments are common components of several Retention BMPs, Biofiltration BMPs, and Treatment Control Measures, including infiltration basins, bioretention, vegetated swales, filter strips, planter boxes, green roofs, dry extended detention basins, wet retention basins, and constructed treatment wetlands.

- 3) Compost, soil conditioners, and fertilizers should be rototilled into the native soil to a minimum depth of 6 inches.

Calculating HSC Retention Volume

No retention credit is given for amended soils alone. Amended soils should be used to increase the retention volume of Retention BMPs, Biofiltration BMPs, and Treatment Control Measures.

Additional References

- San Diego County LID Handbook Appendix 4 (Factsheet 30):
<http://www.sdcountry.ca.gov/dplu/docs/LID-Appendices.pdf>
- Colorado State University Extension website:
<http://www.ext.colostate.edu/pubs/garden/07235.html>

Street Trees

By intercepting rainfall, trees can provide several aesthetic and stormwater benefits including peak flow control, increased infiltration and evapotranspiration, and runoff temperature reduction. The volume of precipitation intercepted by the canopy reduces the treatment volume required for downstream treatment BMPs. Shading reduces the heat island effect as well as the temperature of adjacent impervious surfaces over which stormwater flows, and thus reduces the heat transferred to the downstream waterbody. Tree roots also strengthen the soil structure and provide infiltrative pathways, simultaneously reducing erosion potential and enhancing infiltration.

Design Considerations

- 1) Street trees can be incorporated along sidewalks, streets, parking lots, or driveways.
- 2) Street trees can be used in combination with bioretention systems along medians or in traffic calming bays.
- 3) There must be sufficient space available to accommodate both the tree canopy and the root system.
- 4) The mature tree canopy, height, and root system should not interfere with subsurface utilities, overhead powerlines, buildings and foundations, or other existing or planned structures.
- 5) Depending on space constraints, a 20 to 30 foot canopy (at maturity) is recommended for stormwater mitigation.
- 6) Native, drought-tolerant species should be selected in order to minimize irrigation requirements and improve the long-term viability of the tree.
- 7) Trees shall not impede pedestrian or vehicle sight lines.

- 8) Planting locations shall receive adequate sunlight and wind protection. Other environmental factors shall be considered prior to planting.
- 9) Soils shall be preserved in their natural condition (if appropriate for planting) or restored via soil amendments. If necessary, a landscape architect should be consulted.

Calculating HSC Retention Volume

- 1) The retention volume provided by streets trees via canopy interception is dependent on the tree species, time of the year, and maturity.
- 2) To compute the retention credit, the expected impervious area covered by the full tree canopy after 4 years of growth must be computed (IA_{HSC}). The maximum retention depth credit for canopy interception (d_{HSC}) is 0.05 inches.

Additional References

- California Stormwater BMP Handbook:
http://www.cabmphandbooks.com/Documents/Development/Section_3.pdf
- City of Los Angeles, Street Tree Division - Street Tree Selection Guide:
<http://bss.lacity.org/UrbanForestryDivision/StreetTreeSelectionGuide.htm>
- Portland Stormwater Management Manual:
<http://www.portlandonline.com/bes/index.cfm?c=35122&a=55791>
- San Diego County LID Handbook Fact Sheets:
<http://www.sdcounty.ca.gov/dplu/docs/LID-Appendices.pdf>

Residential Rain Barrels

Rain barrels are above ground storage vessels that capture runoff from roof downspouts during rain events and detain that runoff for later reuse for irrigating landscaped areas.

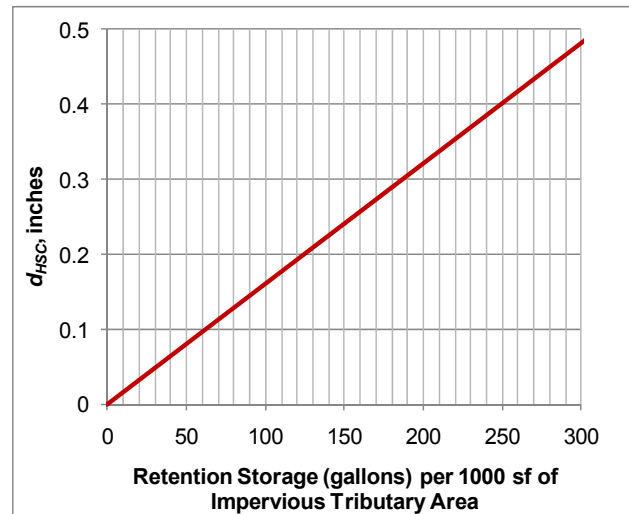
Design Considerations

- 1) If detained water will be used for irrigation, sufficient vegetated areas and other impervious surfaces must be present in the drainage area.
- 2) Storage capacity and sufficient area for overflow dispersion must be accounted for.
- 3) Screens on gutters and downspouts to remove sediment and particles as the water enters the barrel or cistern should be provided.
- 4) Removable child-resistant covers and mosquito screening should be provided to prevent unwanted access.
- 5) Above-ground barrels shall be secured in place.

- 6) Above-ground barrels shall not be located on uneven or sloped surfaces. If installed on a sloped surface, the base where the rain barrel will be installed shall be leveled prior to installation.
- 7) Overflow dispersion shall occur greater than 5 feet from building foundations.
- 8) Dispersion shall not cause geotechnical hazards related to slope stability.
- 9) Effective energy dissipation and uniform flow spreading methods shall be employed to prevent erosion and facilitate dispersion.
- 10) Placement should allow easy access for regular maintenance.

Calculating HSC Retention Volume

- 1) The retention volume provided by rain barrels that are not actively managed can be computed as 50% of the total storage volume (e.g., 22.5 gallons for each 55 gallon barrel).
- 2) If the rain barrel is actively managed, then it should be treated as a cistern (see RWH-1).
- 3) Estimate the average retention volume per 1000 square feet impervious tributary area provided by rain barrels.
- 4) Look up the storm retention depth (d_{HSC}), from the chart to the right.
- 5) The max d_{HSC} is equal to the design storm depth for the project site.



Additional References

- Santa Barbara BMP Guidance Manual, Chapter 6:
http://www.santabarbaraca.gov/NR/rdonlyres/91D1FA75-C185-491E-A882-49EE17789DF8/O/Manual_071008_Final.pdf
- County of Los Angeles LID Standards Manual:
http://dpw.lacounty.gov/wmd/LA_County_LID_Manual.pdf
- SMC LID Manual (pp 114):
http://www.lowimpactdevelopment.org/guest75/pub/All_Projects/SoCal_LID_Manual/SoCalLID_Manual_FINAL_040910.pdf
- San Diego County LID Handbook Appendix 4 (Factsheet 26):
<http://www.sdcounty.ca.gov/dplu/docs/LID-Appendices.pdf>

BIO-1: Bioretention with Underdrain

Bioretention stormwater treatment facilities are landscaped shallow depressions that capture and filter stormwater runoff. These facilities function as a soil and plant based filtration device that removes pollutants through a variety of physical, biological, and chemical treatment processes. The facilities normally consist of a ponding area, mulch layer, planting soils, and plantings. As stormwater passes down through the planting soil, pollutants are filtered, adsorbed, and biodegraded by the soil and plants. Bioretention with an underdrain is a treatment control measures that can be used for areas with low permeability native soils or steep slopes. Bioretention may be designed without an underdrain to serve as a retention BMP in areas of high soil permeability (see [INF-3 Bioretention](#)).



Bioretention in Parking Lots

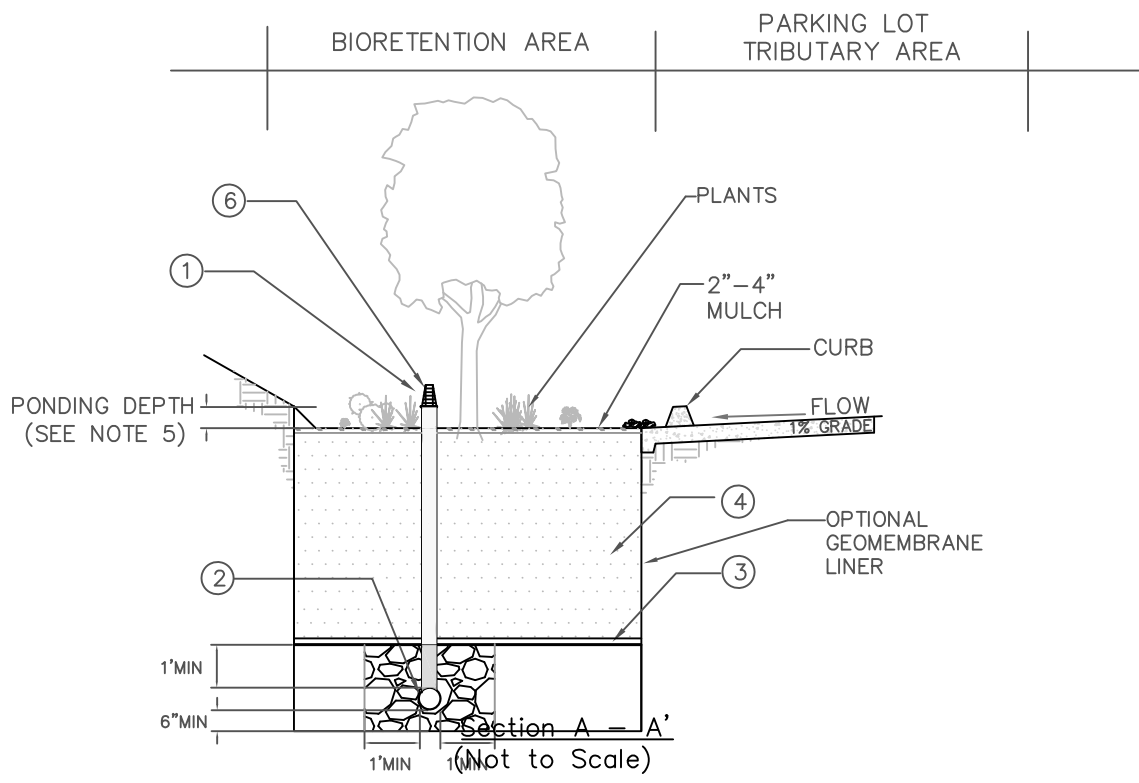
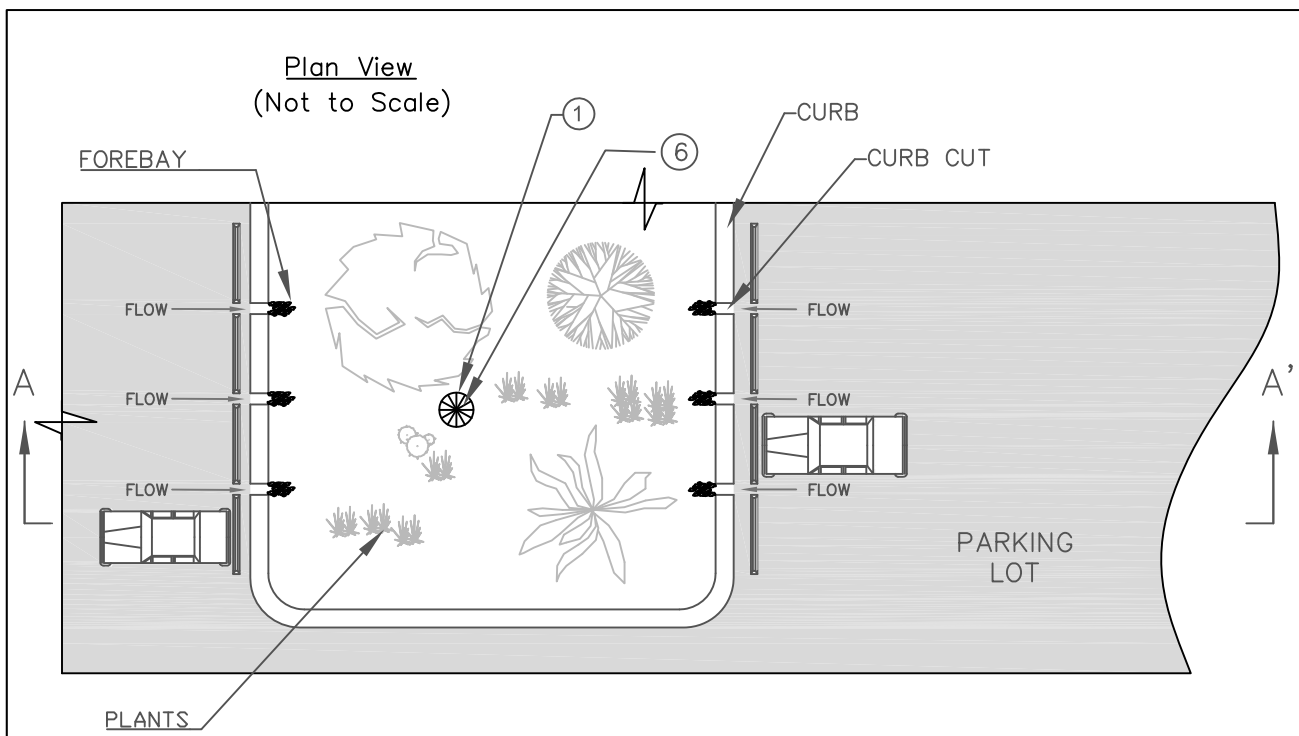
Photo Credits: Geosyntec Consultants

Application

- Parking lots
- Roadway parkways and medians
- School entrances, courtyards, and walkways
- Playgrounds and sports fields

Preventative Maintenance

- Repair small eroded areas
- Remove trash and debris and rake surface soils
- Remove accumulated fine sediments, dead leaves, and trash
- Remove weeds and prune back excess plant growth
- Remove sediment and debris accumulation near inlet and outlet structures
- Periodically observe function under wet weather conditions



NOTES:

- ① OVERFLOW DEVICE: VERTICAL RISER OR EQUIVALENT.
- ② PERFORATED 6" MIN PVC PIPE UNDERDRAIN.
- ③ OPTIONAL CHOKING GRAVEL LAYER.
- ④ 2' MIN PLANTING MIX; 3' PREFERRED.
- ⑤ PONDING DEPTH 18" WITH FENCE; 6" WITHOUT FENCE.
- ⑥ AFFIX PERMANENT IDENTIFICATION TAG.



Figure 6-9: Bioretention with Underdrain

Limitations

- 1) Underdrains are required if the site soil percolation rate is less than 0.5 inches per hour.
- 2) Vertical relief and proximity to storm drain - site must have adequate relief between land surface and storm drain to permit vertical percolation through the soil media and collection and conveyance in underdrain to storm drain system. Sites with steep slopes (greater than 20%) must incorporate a weep garden.
- 3) Depth to groundwater - shallow groundwater table may not permit complete drawdown between storms.

Design Criteria

Bioretention should be designed according to the requirements listed in Table 6-17 and outlined in the section below. BMP sizing worksheets are presented in Appendix E.

Table 6-17: Bioretention Design Criteria

Design Parameter	Unit	Design Criteria
Stormwater quality design volume (SQDV)	acre-feet	See Section 2 and Appendix E for calculating SQDV.
Forebay	-	Forebay should be provided for all tributary surfaces that contain landscaped areas. Forebays should be designed to prevent standing water during dry weather and should be planted with a plant palette that is tolerant of wet conditions.
Maximum drawdown time of planting soil	hours	1248
Maximum drawdown time of gravel drainage layer (if applicable)	hours	No maximum; See Appendix D, Section D.2 for guidance on claiming volume provided below underdrains as “retained” volume.
Maximum ponding depth	inches	18 inches if fenced, 6 inches without fencing.
Minimum thickness of amended soils layer	feet	2 (3 preferred)
Minimum thickness of stabilized mulch	inches	2 to 43
Planting mix composition	-	60 to 70% sand, 15 to 25% compost, and 10 to 20% clean topsoil; organic content 8 to 12%; pH 5.5 to 7.5

Design Parameter	Unit	Design Criteria
Underdrain sizing	-	6 inch minimum diameter; 0.5% minimum slope; slotted, polyvinyl chloride (PVC) pipe (PVC SDR 35 or approved equivalent); spacing shall be determined to provide capacity for maximum rate filtered through amended media
Overflow device	-	Required
Maximum side slope	H:V	2:1 for \leq 6 inch ponding; 3:1 for $>$ 6 inch ponding; Vertical walls may be used with reviewer approval; Design shall provide documentation of how energy dissipation, public safety, and geotechnical considerations are addressed.

Sizing Criteria

Bioretention facilities with underdrains shall be designed to capture and treat the SQDV. However because these systems commonly have a relatively high amended soil infiltration rate and shallow depth, these systems are typically capable of filtering a significant portion of the SQDV during a storm event. Therefore, a simplified routing approach is described in the following steps that accounts for the portion of the SQDV that is filtered during the storm event.

Step 1: Calculate the Design Volume

Bioretention facilities shall be sized to capture and biofilter the SQDV (see Section 2.3 and Appendix E).

Step 2: Determine the Design Percolation Rate

Sizing is based on the design saturated hydraulic conductivity (K_{sat}) of the amended soil layer. A target K_{sat} of 5 inches per hour is recommended for newly installed non-proprietary amended soil media. The media K_{sat} will decline between maintenance cycles as the surface becomes occluded and particulates accumulate in the amended soil layer. A factor of safety of 2.0 should be applied such that the resulting recommended design K_{sat} is 2.5 inches per hour. This value should be used for sizing unless sufficient rationale is provided to justify a higher design K_{sat} .

Step 3: Calculate the surface area

Determine the size of the required infiltrating surface by assuming the SQDV will fill the available ponding depth plus the void spaces in the media, based on the computed porosity of the filter media and optional aggregate layer.

- 1) Select a surface ponding depth (d_p) that satisfies geometric criteria and is congruent with the constraints of the site. Selecting a deeper ponding depth (18 inches maximum) generally yields a smaller footprint, however, it requires greater consideration for public safety and energy dissipation.
- 2) Compute time for selected ponding depth to filter through media:

$$t_{ponding} = \frac{d_p}{K_{design}} 12 \frac{in}{ft} \leq 48 \text{ hours} \quad \text{(Equation 6-14)}$$

Where:

- $t_{ponding}$ = required drain time of surface ponding (48 hrs)
- d_p = selected surface ponding water depth (ft)
- K_{design} = design saturated hydraulic conductivity (in/hr) (see Step 2, above)

If $t_{ponding}$ exceeds 48 hours, return to (1) and reduce surface ponding or increase media K_{design} . Otherwise, proceed to next step.

Note: In nearly all cases, $t_{ponding}$ will not approach 48 hours unless a low K_{design} is specified.

- 3) Compute depth of water that may be filtered during the design storm event as follows:

$$d_{filtered} = \text{Minimum} \left[\frac{K_{design} \times T_{routing}}{12 \frac{in}{ft}}, \frac{d_p}{2} \right] \quad \text{(Equation 6-15),}$$

Where:

- $d_{filtered}$ = depth of water that may be considered to be filtered during the design storm event (ft) for routing calculations; this value should not exceed half of the surface ponding depth (d_p)
- K_{design} = design saturated hydraulic conductivity (in/hr) (see Step 2, above)
- $T_{routing}$ = storm duration that may be assumed for routing calculations; this should be assumed to be **3 hours** unless rationale for an alternative assumption is provided
- d_p = selected surface ponding water depth (ft)

The intention is that routing is important in the appropriate sizing of bioretention with underdrains. However the depth of water considered to be filtered during the storm should be limited to no more than half of the maximum ponding depth. This results in designs that are robust to account for a variety of storm depths and durations. This limitation is for sizing calculations only. In reality, the depth that is filtered during a storm will vary based on storm depth, duration, and intensity. This TGM does not intend to limit the amount that may actually be filtered.

- 4) Calculate required infiltrating surface area (filter bottom area):

$$A_{req} = \frac{SQDV}{d_p + d_{filtered}} \quad \text{(Equation 6-16)}$$

Where:

- A_{req} = required area at bottom of filter area (ft²); does not account for side slopes and freeboard
- $SQDV$ = stormwater quality design volume (ft³)
- d_p = selected surface ponding water depth (ft)
- $d_{filtered}$ = depth of water that can be considered to be filtered during the design storm event (ft) for routing calculations (See Equation 6-15)

- 5) Calculate total footprint required by including a buffer for side slopes and freeboard; A_{req} is measured at the filter bottom area (toe of side slopes).

Geometry

- 1) Bioretention areas shall be sized to capture and treat the SQDV (see Section 2 and Appendix E for calculating SQDV) with an 18-inch maximum ponding depth if fenced to prevent access, or 6 inches without fencing.
- 2) Minimum planting soil depth should be 2 feet, although 3 feet is preferred.

The intention is that the minimum planting soil depth should provide a beneficial root zone for the chosen plant palette and adequate water storage for the stormwater quality design volume. A deeper soil depth will provide a smaller surface area footprint.

- 3) Bioretention should be designed to drain below the planting soil in less than 48 hours and completely drain from the underdrains in 96 hours (both starting from the end of inflow).

The intention is that soils must be allowed to dry out periodically in order to restore hydraulic capacity to receive flows from subsequent storms, maintain

infiltration rates, maintain adequate soil oxygen levels for healthy soil biota and vegetation, and to provide proper soil conditions for biodegradation and retention of pollutants.

Flow Entrance and Energy Dissipation

The following types of flow entrance can be used for bioretention cells:

- 1) Dispersed, low velocity flow across a landscape area. Dispersed flow may not be possible given space limitations or if the facility is controlling roadway or parking lot flows where curbs are mandatory.
- 2) Dispersed flow across pavement or gravel and past wheel stops for parking areas.
- 3) Curb cuts for roadside or parking lot areas: Curb cuts should include rock or other erosion protection material in the channel entrance to dissipate energy. Flow entrance should drop 2 to 3 inches from curb line and provide an area for settling and periodic removal of sediment and coarse material before flow dissipates to the remainder of the cell.
- 4) Pipe flow entrance: Piped entrances, such as roof downspouts, should include rock, splash blocks, or other appropriate measures at the entrance to dissipate energy and disperse flows.
- 5) Woody plants (trees, shrubs, etc.) can restrict or concentrate flows and can be damaged by erosion around the root ball and shall not be placed directly in the entrance flow path.

Underdrains

Underdrains must meet the following criteria:

- 1) 6-inch minimum diameter.
- 2) Underdrains must be made of slotted, polyvinyl chloride (PVC) pipe (PVC SDR 35 or approved equivalent). *The intention is that compared to round-hole perforated pipe, slotted underdrains provide greater intake capacity, clog resistant drainage, and reduced entrance velocity into the pipe, thereby reducing the chances of solids migration.*
- 3) Slotted pipe shall have 2 to 4 rows of slots cut perpendicular to the axis of the pipe or at right angles to the pitch of corrugations. Slots shall be 0.04 to 0.1 inches and shall have a length of 1 to 1.25 inches. Slots shall be longitudinally spaced such that the pipe has a minimum of one square inch of slot per lineal foot of pipe and shall be placed with slots facing the bottom of the pipe.
- 4) Underdrains shall be sloped at a minimum of 0.5%.

- 5) Rigid non-perforated observation pipes with a diameter equal to the underdrain diameter shall be connected to the underdrain every 100 feet to provide a clean-out port as well as an observation well to monitor dewatering rates. The wells/cleanouts shall be connected to the perforated underdrain with the appropriate manufactured connections. The wells/cleanouts shall extend 6 inches above the top elevation of the bioretention facility mulch, and shall be capped with a lockable screw cap. The ends of the underdrain pipes not terminating in an observation well/cleanout shall also be capped.
- 6) The following aggregate shall be used to provide a gravel blanket and bedding for the underdrain pipe. Place the underdrain on a bed of washed aggregate at a minimum thickness of 6 inches and cover it with the same aggregate to provide a 1 foot minimum depth around the top and sides of the slotted pipe.

Sieve size	Percent Passing
¾ inch	100
¼ inch	30-60
US No. 8	20-50
US No. 50	3-12
US No. 200	0-1

- 7) At the option of the designer/geotechnical engineer, a geotextile fabric may be placed between the planting media and the drain rock. If a geotextile fabric is used, it must meet a minimum permittivity rate of 75 gal/min/ft², should not impede the infiltration rate of the soil medium, and must meet the following minimum materials requirements.

Geotextile Property	Value	Test Method
Trapezoidal Tear (lbs)	40 (min)	ASTM D4533
Permeability (cm/sec)	0.2 (min)	ASTM D4491
AOS (sieve size)	#60 - #70 (min)	ASTM D4751
Ultraviolet resistance	70% or greater	ASTM D4355

Preferably, aggregate should be used in place of filter fabric to reduce the potential for clogging. This aggregate layer should consist of 2 to 4 inches of washed sand underlain with 2 inches of choking stone (Typically #8 or #89 washed).

- 8) The underdrain shall be elevated from the bottom of the bioretention facility by 6 inches within the gravel blanket to create a fluctuating anaerobic/aerobic zone below the drain pipe. *The intention is that denitrification within the anaerobic/anoxic zone is facilitated by microbes using forms of nitrogen (NO₂ and NO₃) instead of oxygen for respiration.*

- 9) The underdrain must drain freely to an acceptable discharge point. The underdrain can be connected to a downstream open conveyance (vegetated swale), to another bioretention cell as part of a connected treatment system, to a storm drain, daylight to a vegetated dispersion area using an effective flow dispersion device, or to a storage facility for reuse.

Overflow

An overflow device is required at the 18 inch ponding depth. The following, or equivalent, should be provided:

- 1) A vertical PVC pipe (SDR 35) shall be connected to the underdrain.
- 2) The overflow riser(s) should be 6 inches or greater in diameter, so it can be cleaned without damage to the pipe. The vertical pipe will provide access to cleaning the underdrains.
- 3) The inlet to the riser should be at the ponding depth (18 inches for fenced bioretention areas and 6 inches for areas that are not fenced), and be capped with a spider cap to exclude floating mulch and debris. Spider caps shall be screwed in or glued (i.e., not removable).

Hydraulic Restriction Layers

Infiltration pathways may need to be restricted due to the close proximity of roads, foundations, or other infrastructure. A geomembrane liner, or other equivalent water proofing, may be placed along the vertical walls to reduce lateral flows. This liner shall have a minimum thickness of 30 mils.

Planting/Storage Media

- 1) The planting media placed in the cell shall be highly permeable and high in organic matter (e.g., loamy sand mixed thoroughly with compost amendment) and a surface mulch layer.
- 2) Planting media shall consist of 60 to 70% sand, 15 to 25% compost, and 10 to 20% clean topsoil. The organic content of the soil mixture should be 8% to 12%. The pH range should be 5.5 to 7.5.
- 3) Sand should be free of stones, stumps, roots, or other similar objects larger than 5 millimeters, and have the following gradation:

Sieve Size (ASTM D422)	% Passing
#4	100
#6	88-100
#8	79-97
#50	11-35
#200	5-15

- 4) Compost should be free of stones, stumps, roots or other similar objects larger than ¾ inches, have a particle size of 98% passing through ¾ inch screen or smaller, and meet the following characteristics:
- Soluble salt concentration: < 10 mmhos/cm (dS/m)
 - pH: 5.0 to 8.5
 - Moisture: 30 to 60% wet weight basis
 - Organic matter: 30 to 65% dry weight basis
 - Stability (carbon dioxide evolution rate): >80% relative to positive control
 - Maturity (seed emergence and seedling vigor): >80% relative to positive control
 - Physical contaminants: < 1% dry weight basis
- 5) Topsoil shall be free of stones, stumps, roots, or other similar objects larger than 2 inches, and have the following characteristics:

Particle Size	% Passing
¾ inch	98
Sand (0.05 - 2.0 mm)	50-75
Silt (0.002 - 0.05 mm)	15-40
Clay	< 5

- Soluble salts: < 4.0 mmhos/cm (dS/m)
 - pH range: 5.5 to 7.0
 - Organic matter: > 5%
 - Carbon to nitrogen ratio: < 20:1
 - Moisture content: 25-55%
- 6) The bioretention area shall be covered with 2 to 4 inches (average 3 inches) of mulch at the start and an additional placement of 1 to 2 inches of mulch shall be added annually. *The intention is that this will help sustain nutrient levels, suppress weeds, and maintain infiltrative capacity.*

Mulch shall be the following:

- Well-aged, shredded or chipped woody debris or plant material. Well-aged mulch is defined as mulch that has been stockpiled or stored for at least twelve (12)

months. Compost meeting the requirements of No. 4 above may also be used (compost is less likely to float and is a better source for organic materials).

- Free of weed seeds, soil, roots, bark, and trunk or branch wood.
 - A maximum of 2 to 3 inches thick. *The intention is that thicker applications can inhibit proper oxygen and carbon dioxide cycling between the soil and atmosphere.*
 - Grass clippings or pure bark shall not be used as mulch.
- 7) Planting media design height shall be marked appropriately, such as a collar on the vertical riser (if installed), or with a stake inserted 2 feet into the planting media and notched to show bioretention surface level and ponding level.
- 8) The bioretention soil mix shall be tested and meet the following criteria:

Item	Criteria	Test Method
Corrected pH	5.5 – 7.5	ASTM D4972
Magnesium	Minimum 32 ppm	*
Phosphorus (Phosphate)	Not to exceed 69 ppm	*
Potassium (K ₂ O)	Minimum 78 ppm	*
Soluble Salts	Not to exceed 500 ppm	*

* Use authorized soil test procedures.

pH. Should the pH fall outside of the acceptable range, it may be modified with lime (to raise the pH) or iron sulfate plus sulfur (to lower the pH). The lime or iron sulfate must be mixed uniformly into the soil mix prior to use in bioretention facilities. Should the soil mix not meet the minimum requirement for magnesium, it may be modified with magnesium sulfate. Likewise, should the soil mix not meet the minimum requirement for potassium, it may be modified with potash. Magnesium sulfate and potash must be mixed uniformly into the soil mix prior to use in bioretention facilities.

Limestone. Limestone shall contain not less than 85 percent calcium and magnesium carbonates. Dolomitic (magnesium) limestone shall contain at least 10 percent magnesium as magnesium oxide and 85 percent calcium and magnesium carbonates.

Limestone shall conform to the following gradation:

Sieve Size	Minimum Percent Passing By Weight
No. 10	100
No. 20	98
No. 100	50

Iron Sulfate. Iron sulfate shall be a constituent of an approved horticultural product produced as a fertilizer for supplying iron and as a soil acidifier.

Magnesium Sulfate. Magnesium sulfate shall be a constituent of an approved horticultural product produced as a fertilizer.

Potash. Potash (potassium oxide) shall be a constituent of an approved horticultural product produced as a fertilizer.

Plants

- 1) Prior to installation, a licensed landscape architect shall certify that all plants, unless otherwise specifically permitted, conform to the standards of the current edition of American Standard for Nursery Stock as approved by the American Standards Institute, Inc. All plant grades shall be those established in the current edition of American Standards for Nursery Stock.
- 2) Shade trees shall have a single main trunk. Trunks shall be free of branches (of caliper specified) below the following heights:

Caliper (in)	Height (ft)
1.5 to 2.5	5
3	6

- 3) Plant materials shall be tolerant of summer drought, ponding fluctuations, and saturated soil conditions for 48 hours.
- 4) It is recommended that a minimum of three tree, three shrubs, and three herbaceous groundcover species be incorporated to protect against facility failure due to disease and insect infestations of a single species.
- 5) Plant rooting depths shall not damage underdrain if present. Slotted or perforated underdrain pipe should be more than 5 feet from tree locations (if space allows).
- 6) Native plant species and/or hardy cultivars that are not invasive and do not require chemical inputs shall be used to the maximum extent practicable.

Operations and Maintenance

Bioretention areas require annual plant, soil, and mulch layer maintenance to ensure optimum infiltration, storage, and pollutant removal capabilities. In general, bioretention maintenance requirements are typical landscape care procedures and include:

- 7) **Watering:** Plants should be selected to be drought-tolerant and not require watering after establishment (2 to 3 years). Watering may be required during prolonged dry periods after plants are established.
- 8) **Erosion control:** Inspect flow entrances, ponding area, and surface overflow areas periodically, and replace soil, plant material, and/or mulch layer in areas if erosion has occurred (see Appendix I for a bioretention inspection and maintenance checklist). Properly designed facilities with appropriate flow velocities should not have erosion problems except perhaps in extreme events. If erosion problems occur, the following should be reassessed: (1) flow velocities and gradients within the cell, and (2) flow dissipation and erosion protection strategies in the pretreatment area and flow entrance. If sediment is deposited in the bioretention area, immediately determine the source within the contributing area, stabilize, and remove excess surface deposits.
- 9) **Plant material:** Depending on aesthetic requirements, occasional pruning and removing of dead plant material may be necessary. Replace all dead plants and if specific plants have a high mortality rate, assess the cause and, if necessary, replace with more appropriate species. Periodic weeding is necessary until plants are established. The weeding schedule should become less frequent if the appropriate plant species and planting density have been used and, as a result, undesirable plants have been excluded.
- 10) **Nutrient and pesticides:** The soil mix and plants are selected for optimum fertility, plant establishment, and growth. Nutrient and pesticide inputs should not be required and may degrade the pollutant processing capability of the bioretention area, as well as contribute pollutant loads to receiving waters. By design, bioretention facilities are located in areas where phosphorous and nitrogen levels are often elevated and these should not be limiting nutrients. If in question, have soil analyzed for fertility.
- 11) **Mulch:** Replace mulch annually in bioretention facilities where heavy metal deposition is likely (e.g., contributing areas that include industrial and auto dealer/repair parking lots and roads). In residential lots or other areas where metal deposition is not a concern, replace or add mulch as needed to maintain a 2 to 3 inch depth at least once every two years.
- 12) **Soil:** Soil mixes for bioretention facilities are designed to maintain long-term fertility and pollutant processing capability. Estimates from metal attenuation research suggest that metal accumulation should not present an environmental concern for at least 20 years in bioretention systems. Replacing mulch in bioretention facilities where heavy metal deposition is likely provides an additional level of protection for prolonged performance. If in question, have soil analyzed for fertility and pollutant levels.

BIO-2: Planter Box

Planter boxes are bioretention treatment control measures that are completely contained within an impermeable structure with an underdrain (they do not infiltrate). These facilities function as a soil and plant based filtration device that removes pollutants through a variety of physical, biological, and chemical treatment processes. The facilities normally consist of a ponding area, mulch layer, planting soils, plantings, and an underdrain within the planter box. As stormwater passes down through the planting soil, pollutants are filtered, adsorbed, and biodegraded by the soil and plants. Planter boxes are comprised of a variety of materials, usually chosen to be the same material as the adjacent building or sidewalk.

Planter boxes may be placed adjacent to or near buildings, other structures, or sidewalks. Planter boxes can be used directly adjacent to buildings beneath downspouts as long as the boxes are properly lined on the building side and the overflow outlet discharges away from the building to ensure water does not percolate into footings or foundations. They can also be placed further away from buildings by conveying roof runoff in shallow engineered open conveyances, shallow pipes, or other innovative drainage structures.



Planter boxes extending along a building wall

Photo Credit: Geosyntec Consultants

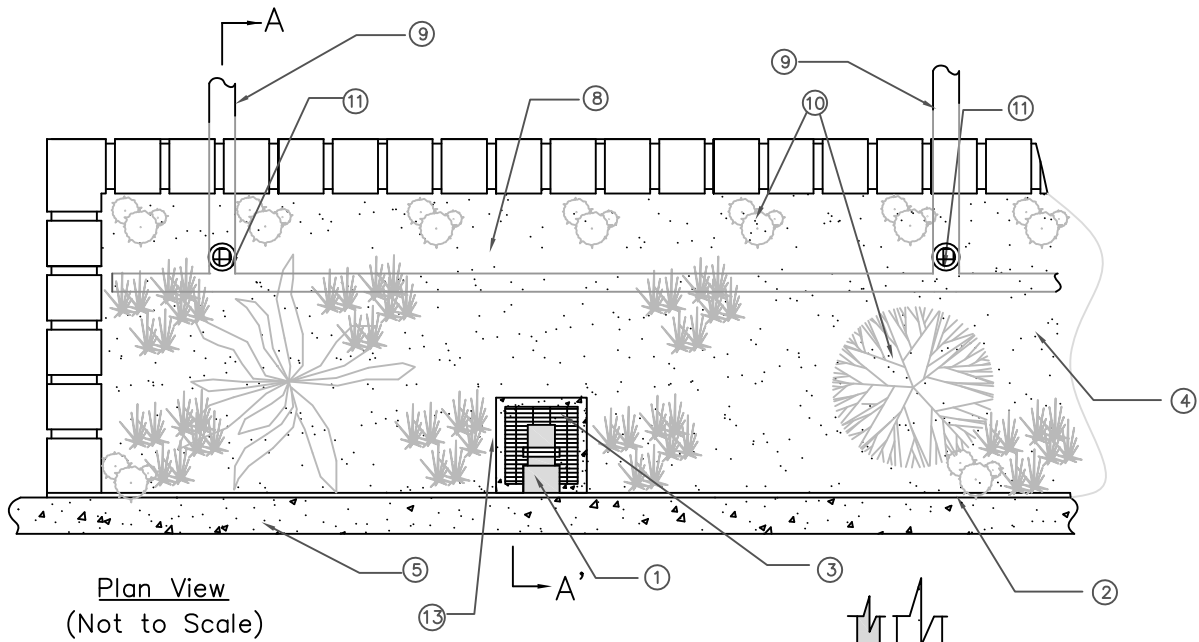
Application

- Areas adjacent to buildings and sidewalks
- Building entrances, courtyards, and walkways

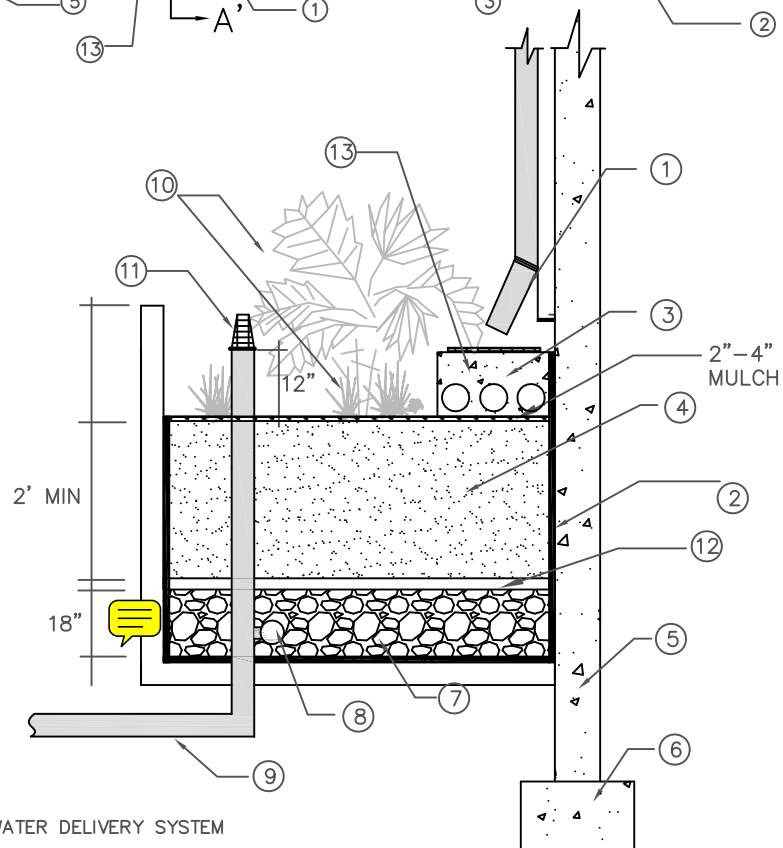
Preventative Maintenance

- Repair small eroded areas
- Remove trash and debris and rake surface soils
- Remove accumulated fine sediments, dead leaves, and trash
- Remove weeds and prune back excess plant growth
- Remove sediment and debris accumulation near inlet and outlet structures

Periodically observe function under wet weather conditions



Section A - A'
(Not to Scale)



NOTES:

- ① ROOF DOWNSPOUT OR OTHER STORMWATER DELIVERY SYSTEM
- ② WATERPROOF BARRIER
- ③ SHALLOW ENERGY DISSIPATOR BASIN DISPERSES FLOW AT SOIL SURFACE
- ④ SOIL MIX (SEE PLANTING MEDIA SECTION)
- ⑤ BUILDING
- ⑥ FOUNDATION. INSTALL FOUNDATION DRAINS AS NEEDED
- ⑦ GRAVEL BEDDING (SEE UNDERDRAIN)
- ⑧ PERFORATED PIPE SHALL RUN ENTIRE LENGTH OF PLANTER
- ⑨ CONNECTION TO DOWNSTREAM CONVEYANCE SYSTEM
- ⑩ PLANTS
- ⑪ SET OVERFLOW 2" BELOW THE TOP OF THE PLANTER
- ⑫ OPTIONAL CHOKING GRAVEL LAYER
- ⑬ AFFIX PERMANENT IDENTIFICATION TAG.

Geosyntec
consultants

Figure 6-10: Planter Box

Limitations

The applicability of stormwater planter boxes is limited by the following site characteristics:

- 1) The tributary area (area draining to the planter box area) should be less than 15,000 ft².
- 2) Groundwater levels should be at least 2 ft lower than the bottom of the planter box.
- 3) Site must have adequate vertical relief between land surface and the stormwater conveyance system to permit connection of the underdrain to the stormwater conveyance system.
- 4) Planter boxes should not be located in areas with excessive shade to avoid poor vegetative growth. For moderately shaded areas, shade tolerant plants should be used.

Design Criteria

Planter boxes should be designed according to the requirements listed in Table 6-18 and outlined in the section below. BMP sizing worksheets are presented in Appendix E.

Table 6-18: Planter Box Design Criteria

Design Parameter	Unit	Design Criteria
Stormwater quality design volume (SQDV)	acre-feet	See Section 2 and Appendix E for calculating SQDV.
Drawdown time of planting soil	hours	12
Maximum ponding depth	inches	12
Minimum soil depth	feet	2; 3 preferred
Stabilized mulch depth	inches	2 to 3
Planting soil composition	-	60 to 70% sand, 15 to 25% compost, and 10 to 20% clean topsoil; organic content 8 to 12%; pH 5.5 to 7.5
Underdrain	-	6 inch minimum diameter; 0.5% minimum slope; slotted, polyvinyl chloride (PVC) pipe (PVC SDR 35 or approved equivalent)
Overflow device	-	Required

Sizing Criteria

See [Sizing Criteria](#) section in the BIO-1: Bioretention with underdrains fact sheet.

Geometry and Size

- 1) Planter boxes areas shall be sized to capture and treat the SQDV with a 12 inch maximum ponding depth. The mulch layer shall be included as part of the ponding depth.
- 2) Minimum soil depth shall be 2 feet, although 3 feet is preferred. *The intention is that a minimum soil depth shall provide a beneficial root zone for the chosen plant palette and adequate water storage for the SQDV. A deeper planting soil depth will provide a smaller surface area footprint.*
- 3) Planter boxes shall be designed to drain to below the planting soil depth in less than 48 hours. *The intention is that soils must be allowed to dry out periodically in order to restore hydraulic capacity to receive flows from subsequent storms, maintain infiltration rates, prevent long periods of saturation for plant health, maintain adequate soil oxygen levels for healthy soil biota and vegetation, reduce potential for vector breeding, and provide proper soil conditions for biodegradation and retention of pollutants.*
- 4) Any planter box shape configuration is possible as long as other design criteria are met.
- 5) The distance between the downspouts and the overflow outlet should be maximized. *The intention is to increase the opportunity for stormwater retention and filtration.*

Structural Materials


- 1) Planter boxes shall be constructed out of stone, concrete, brick, recycled plastic, or other permanent materials. Pressure-treated wood or other materials that may leach pollutants (e.g., arsenic, copper, zinc, etc.) shall not be allowed.
- 2) The structure should be adequately sealed or a waterproof membrane installed to ensure water only exits the structure via the underdrain.

Flow Entrance and Energy Dissipation

The following types of flow entrance can be used for planter boxes:

- 1) Pipe flow entrance: Piped entrances, such as roof downspouts, shall include rock, splash blocks, or other appropriate measures at the entrance to dissipate energy and disperse flows.
- 2) Woody plants (e.g., trees, shrubs, etc.) can restrict or concentrate flows and can be damaged by erosion around the root ball and shall not be placed directly in the entrance flow path.

Underdrains

Underdrains  are required and must meet the following criteria:

- 1) 6-inch minimum diameter.
- 2) Underdrains must be made of slotted, polyvinyl chloride (PVC) pipe (PVC SDR 35 or approved equivalent). *The intention is that in comparison to round-hole perforated pipe, slotted underdrains provide greater intake capacity, clog resistant drainage, and reduced entrance velocity into the pipe, thereby reducing the chances of solids migration.*
- 3) Slotted pipe shall have 2 to 4 rows of slots cut perpendicular to the axis of the pipe or at right angles to the pitch of corrugations. Slots shall be 0.04 to 0.1 inch and shall have a length of 1 to 1.25 inches. Slots shall be longitudinally spaced such that the pipe has a minimum of one square inch opening per lineal foot and should face down.
- 4) Underdrains shall be sloped at a minimum of 0.5%.
- 5) Rigid non-perforated observation pipes with a diameter equal to the underdrain diameter shall be connected to the underdrain every 100 feet to provide a clean-out port as well as an observation well to monitor dewatering rates. The wells/cleanouts shall be connected to the perforated underdrain with the appropriate manufactured connections. The wells/cleanouts shall extend 6 inches above the top elevation of the bioretention facility mulch, and shall be capped with a lockable screw cap. The ends of underdrain pipes not terminating in an observation well/cleanout shall also be capped.
- 6) The following aggregate shall be used to provide a gravel blanket and bedding for the underdrain pipe. Place the underdrain on a bed of washed aggregate at a minimum thickness of 6 inches and cover it with the same aggregate to provide a 1 foot minimum depth around the top and sides of the slotted pipe.

Sieve size	Percent Passing
¾ inch	100
¼ inch	30-60
US No. 8	20-50
US No. 50	3-12
US No. 200	0-1

- 7) At the option of the designer/geotechnical engineer, a geotextile fabric may be placed between the planting media and the drain rock. If a geotextile fabric is used, it must meet a minimum permittivity rate of 75 gal/min/ft², should not impede the infiltration rate of the soil medium, and must meet the following minimum materials requirements.

Geotextile Property	Value	Test Method
Trapezoidal Tear (lbs)	40 (min)	ASTM D4533
Permeability (cm/sec)	0.2 (min)	ASTM D4491
AOS (sieve size)	#60 - #70 (min)	ASTM D4751
Ultraviolet resistance	70% or greater	ASTM D4355

Preferably, aggregate should be used in place of filter fabric to reduce the potential for clogging. This aggregate layer should consist of 2 to 4 inches of washed sand underlain with 2 inches of choking stone (Typically #8 or #89 washed).

- 8) The underdrain shall be elevated from the bottom of the bioretention facility by 6 inches within the gravel blanket to create a fluctuating anaerobic/aerobic zone below the drain pipe. *The intention is that denitrification within the anaerobic/anoxic zone is facilitated by microbes using forms of nitrogen (NO₂ and NO₃) instead of oxygen for respiration.*
- 9) The underdrain must drain freely to an acceptable discharge point. The underdrain can be connected to a downstream open conveyance (vegetated swale), to another bioretention cell as part of a connected treatment system, to a storm drain, daylight to a vegetated dispersion area using an effective flow dispersion device, or to a storage facility for reuse.

Overflow

An overflow device is required to be set at 2 inches below the top of the planter and no more than 12 inches above the soil surface. The most common option is a vertical riser, described below.

Vertical riser

- 1) A vertical PVC pipe (SDR 35) shall be connected to the underdrain.
- 2) The overflow riser(s) shall be 6 inches or greater in diameter, so it can be cleaned without damage to the pipe. The vertical pipe will provide access to cleaning the underdrains.
- 3) The inlet to the riser shall be a maximum of 12 inches above the planting soil, and be capped with a spider cap. Spider caps shall be screwed in or glued (i.e., not removable).

Hydraulic Restriction Layers

A waterproof barrier should be provided to restrict moisture away from foundations. Geomembrane liners shall have a minimum thickness of 30 mils. Equivalent waterproofing measures may be used.

Planting/Storage Media

- 1) The planting media placed in the cell shall be highly permeable and high in organic matter (e.g., loamy sand mixed thoroughly with compost amendment) and a surface mulch layer.
- 2) Planting media shall consist of 60 to 70% sand, 15 to 25% compost, and 10 to 20% clean topsoil. The organic content of the soil mixture should be 8% to 12%. The pH range should be 5.5 to 7.5.
- 3) Sand should be free of stones, stumps, roots, or other similar objects larger than 5 millimeters, and have the following gradation:

Particle Size (ASTM D422)	% Passing
#4	100
#6	88-100
#8	79-97
#50	11-35
#200	5-15

- 4) Compost should be free of stones, stumps, roots or other similar objects larger than ¾ inches, have a particle size of 98% passing through ¾ inch screen or smaller, and meet the following characteristics:
 - Soluble salt concentration: < 10 mmhos/cm (dS/m)
 - pH: 5.0 to 8.5
 - Moisture: 30 to 60% wet weight basis
 - Organic matter: 30 to 65% dry weight basis
 - Stability (carbon dioxide evolution rate): >80% relative to positive control
 - Maturity (seed emergence and seedling vigor): >80% relative to positive control
 - Physical contaminants: < 1% dry weight basis

- 5) Topsoil shall be free of stones, stumps, roots, or other similar objects larger than 2 inches, and have the following characteristics:

Particle Size (ASTM D422, D1140)	% Passing
¾ inch	98
Sand (0.05 - 2.0 mm)	50-75
Silt (0.002 - 0.05 mm)	15-40

Clay	< 5
------	-----

- -
 - Soluble salts: < 4.0 mmhos/cm (dS/m)
 - pH range: 5.5 to 7.0
 - Organic matter: > 5%
 - Carbon to nitrogen ratio: < 20:1
 - Moisture content: 25 to 55%
- 6) The bioretention area shall be covered with 2 to 4 inches (average 3 inches) of mulch at the start and an annual placement of 1 to 2 inches of mulch. *The intention is that this will help sustain nutrient levels, suppress weeds, and maintain infiltrative capacity.*

Mulch shall be the following:

- Well-aged, shredded or chipped woody debris or plant material. Well-aged mulch is defined as mulch that has been stockpiled or stored for at least twelve (12) months. Compost meeting the requirements above may also be used (compost is less likely to float and is a better source for organic materials).
 - Free of weed seeds, soil, roots, and other material that is not bole or branch wood and bark.
 - A maximum of 2 to 3 inches thick. *The intention is that thicker applications can inhibit proper oxygen and carbon dioxide cycling between the soil and atmosphere.*
 - Grass clippings or pure bark shall not be used as mulch.
- 7) Planting media design height shall be marked appropriately, such as a collar on the vertical riser (if installed), or with a stake inserted 2 feet into the planting media and notched to show bioretention surface level and ponding level.
- 8) The bioretention soil mix shall be tested and meet the following criteria:

Item	Criteria	Test Method
Corrected pH	5.5 – 7.5	ASTM D4972
Magnesium	Minimum 32 ppm	*
Phosphorus (Phosphate - P ₂ O ₅)	Not to exceed 69 ppm	*
Potassium (K ₂ O)	Minimum 78 ppm	*
Soluble Salts	Not to exceed 500 ppm	*

* Use authorized soil test procedures.

pH. Should the pH fall outside of the acceptable range, it may be modified with lime (to raise the pH) or iron sulfate plus sulfur (to lower the pH). The lime or iron sulfate must be mixed uniformly into the soil mix prior to use in bioretention facilities. Should the soil mix not meet the minimum requirement for magnesium, it may be modified with magnesium sulfate. Likewise, should the soil mix not meet the minimum requirement for potassium, it may be modified with potash. Magnesium sulfate and potash must be mixed uniformly into the soil mix prior to use in bioretention facilities.

Limestone. Limestone shall contain not less than 85 percent calcium and magnesium carbonates. Dolomitic (magnesium) limestone shall contain at least 10 percent magnesium as magnesium oxide and 85 percent calcium and magnesium carbonates.

Limestone shall conform to the following gradation:

Sieve Size	Minimum Percent Passing By Weight
No. 10	100
No. 20	98
No. 100	50

Iron Sulfate. Iron sulfate shall be a constituent of an approved horticultural product produced as a fertilizer for supplying iron and as a soil acidifier.

Magnesium Sulfate. Magnesium sulfate shall be a constituent of an approved horticultural product produced as a fertilizer.

Potash. Potash (potassium oxide) shall be a constituent of an approved horticultural product produced as a fertilizer.

Plants

- 1) Prior to installation, a licensed landscape architect shall certify that all plants, unless otherwise specifically permitted, conform to the standards of the current edition of American Standard for Nursery Stock as approved by the American Standards Institute, Inc.
- 2) Shade trees shall have a single main trunk. Trunks shall be free of branches below the following heights:

Caliper (in)	Height (ft)
1.5 to 2.5	5
3	6

- 3) Plant materials shall be tolerant of summer drought, ponding fluctuations, and saturated soil conditions for 48 hours.
- 4) It is recommended that a minimum of three tree, three shrubs, and three herbaceous groundcover species be incorporated to protect against facility failure due to disease and insect infestations of a single species. Plant rooting depths shall not damage underdrain if present. Slotted or perforated underdrain pipe should be more than 5 feet from tree locations (if space allows).
- 5) Native plant species and/or hardy cultivars that are not invasive and do not require chemical inputs shall be used to the maximum extent practicable.
- 6) Only slow-release fertilizers shall be used to limit the potential for excessive nutrient discharge.
- 7) Annual replacement of 1 to 2 inches of mulch (may be the same as compost used for planting mix) is required to sustain nutrient levels, suppress weeds, and maintain infiltrative capacity.

Construction Considerations

- 1) Material of planter boxes shall be selected carefully to blend in and enhance aesthetics of adjacent structures (buildings and sidewalks).
- 2) Plants shall be selected carefully to minimize maintenance and function properly.

Operations and Maintenance

Planter boxes require annual plant, soil, and mulch layer maintenance to ensure optimum infiltration, storage, and pollutant removal capabilities. In general, planter box maintenance requirements are typical of landscape care procedures and include:

- 1) Watering: Plants shall be selected to be drought-tolerant and do not require watering after establishment (2 to 3 years). Watering may be required during prolonged dry periods after plants are established.
- 2) Erosion control: Inspect flow entrances, ponding area, and surface overflow areas periodically, and replace soil, plant material, and/or mulch layer in areas if erosion has occurred (see Appendix I for an inspection and maintenance checklist). Properly designed facilities with appropriate flow velocities shall not have erosion problems except perhaps in extreme events. If erosion problems occur, the following shall be reassessed: (1) flow velocities and gradients within the cell, and (2) flow dissipation and erosion protection strategies in the flow entrance. If sediment is deposited in the

- planter box, immediately determine the source within the contributing area, stabilize, and remove excess surface deposits.
- 3) Plant material: Depending on aesthetic requirements, occasional pruning and removing of dead plant material may be necessary. Replace all dead plants and if specific plants have a high mortality rate, assess the cause and, if necessary, replace with more appropriate species. Periodic weeding is necessary until plants are established. The weeding schedule shall become less frequent if the appropriate plant species and planting density have been used and, as a result, undesirable plants have been excluded.
 - 4) Nutrients and pesticides: The soil mix and plants are selected for optimum fertility, plant establishment, and growth. Nutrient and pesticide inputs should not be required and may degrade the pollutant processing capability of the planter box area, as well as contribute pollutant loads to receiving waters. By design, planter boxes are located in areas where phosphorous and nitrogen levels are often elevated and these should not be limiting nutrients. If in question, have soil analyzed for fertility.
 - 5) Mulch: Replace mulch annually in planter boxes where heavy metal deposition is likely (e.g., contributing areas that include industrial, auto dealer/repair, parking lots, and roads). In residential lots or other areas where metal deposition is not a concern, replace or add mulch as needed to maintain a 2 to 3 inch depth at least once every two years.
 - 6) Soil: Soil mixes for planter boxes are designed to maintain long-term fertility and pollutant processing capability. Estimates from metal attenuation research suggest that metal accumulation should not present an environmental concern for at least 20 years in planter boxes. Replacing mulch in planter boxes where heavy metal deposition is likely provides an additional level of protection for prolonged performance. If in question, have soil analyzed for fertility and pollutant levels.

BIO-3: Vegetated Swale

Vegetated swales are open, shallow channels with low-lying vegetation covering the side slopes and bottom that collect and slowly convey runoff to downstream discharge points. Vegetated swales provide pollutant removal through settling and filtration in the vegetation (usually grasses) lining the channels, provide the opportunity for stormwater volume reduction through infiltration and evapotranspiration, reduce the flow velocity, and conveying stormwater runoff. An effective vegetated swale achieves uniform sheet flow through a densely vegetated area for a period of several minutes. The vegetation in the swale can vary depending on its location and is the choice of the designer, depending on the design criteria outlined in this section.



Vegetated swale captures flow from a residential street

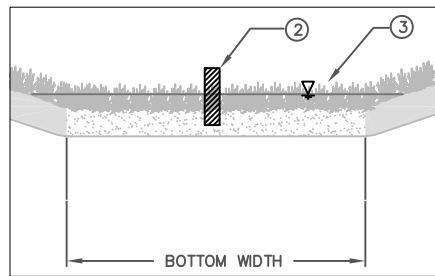
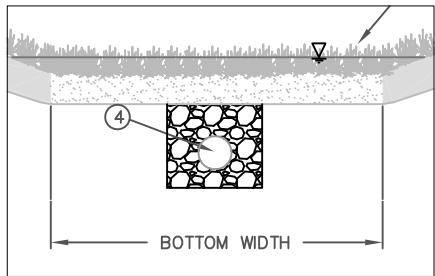
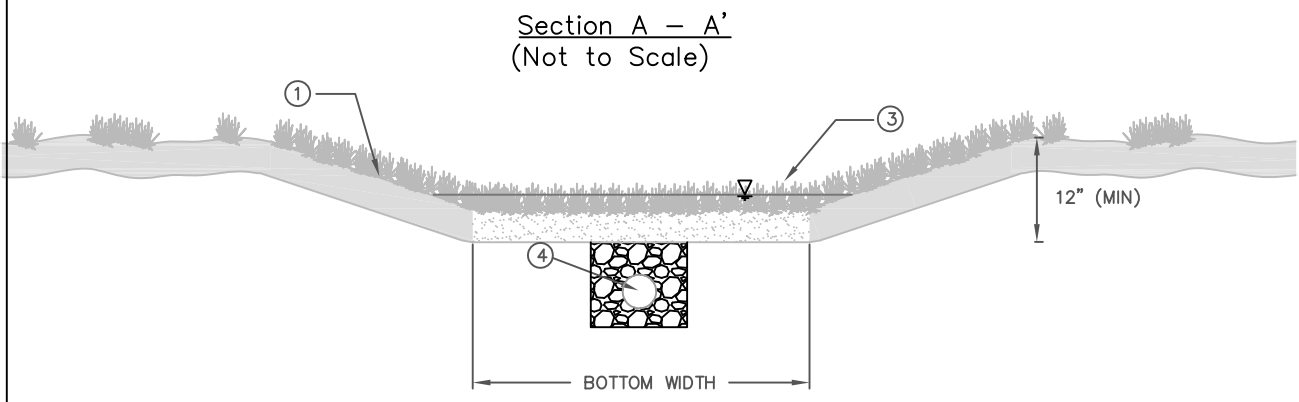
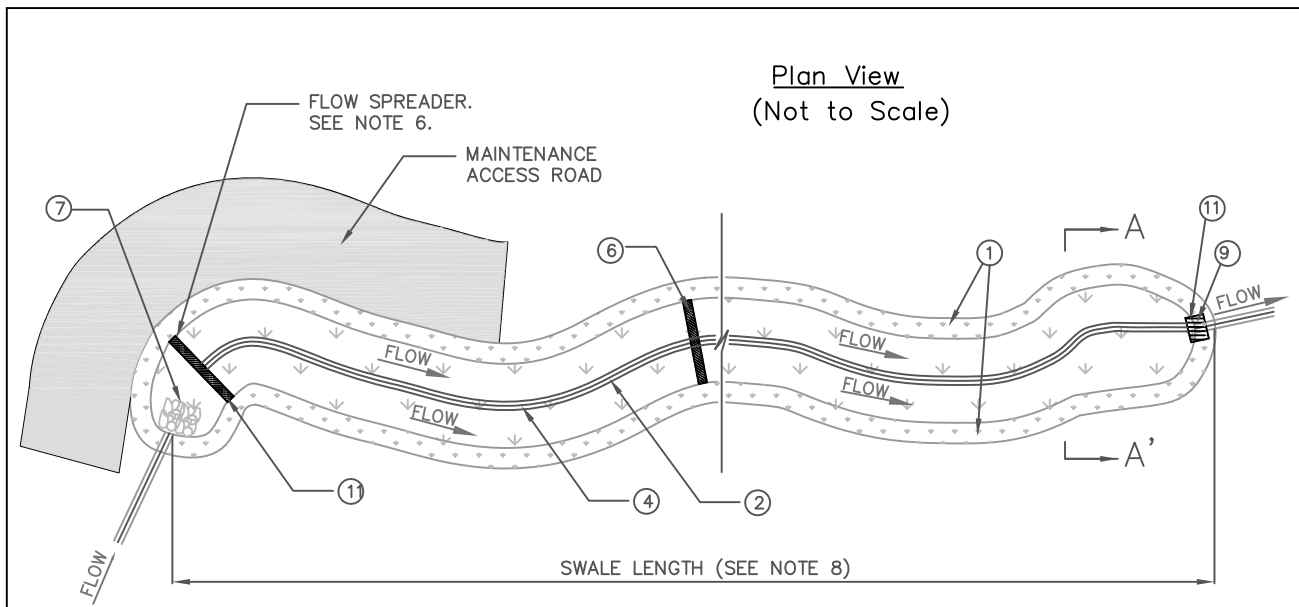
Photo Credit: Geosyntec Consultants

Application

- Open areas adjacent to parking lots
- Open spaces adjacent to athletic fields
- Roadway medians and shoulders

Preventative Maintenance

- Remove excess sediment, trash, and debris
- Clean and reset flow spreaders
- Mow regularly
- Remove sediment and debris build-up near inlets and outlets
- Repair minor erosion and scouring



NOTES:

- ① MOWED TURF SWALES HAVE 4H:1V MAXIMUM SIDE SLOPE, 5H:1V OR FLATTER PREFERRED.
- ② SWALE DIVIDER REQUIRED FOR BOTTOM WIDTHS > 10'. MINIMUM REQUIRED BOTTOM WIDTH IS 2' EXCLUDING WIDTH OF LOW FLOW CHANNEL. MAXIMUM BOTTOM WIDTH WITH DIVIDER IS 16'.
- ③ DEPTH OF FLOW FOR WATER QUALITY TREATMENT MUST NOT EXCEED TWO-THIRDS OF VEGETATION HEIGHT OR NOT GREATER THAN 2" FOR FREQUENTLY MOWED TURF.
- ④ IF AN UNDERDRAIN IS REQUIRED, IT MUST CONSIST OF AN AT LEAST 6" DIAMETER PERFORATED PIPE IN COARSE AGGREGATE BED CONNECTED TO STORM DRAIN. GRAVEL BED MUST EXTEND 6" BELOW AND 12" TO THE SIDE AND TOP OF THE PIPE.
- ⑤ IF NO UNDERDRAIN, LOW FLOW DRAIN SHALL EXTEND ENTIRE LENGTH OF SWALE AND SHALL HAVE A DEPTH OF 6" MINIMUM AND WIDTH NO MORE THAN 5% SWALE BOTTOM WIDTH. ANCHORED PLATE FLOW SPREADER IF USED, SHALL HAVE V-NOTCHES (MAX TOP WIDTH = 5% OF SWALE WIDTH) OR HOLES TO ALLOW PREFERENTIAL EXIT OF LOW FLOWS.
- ⑥ INSTALL CHECK DAMS OR GRADE CONTROL STRUCTURES FOR SLOPES > 2% AT 50' MAXIMUM SPACING TO ACHIEVE A MAXIMUM EFFECTIVE LONGITUDINAL SLOPE OF 2%. FLOW SPREADERS SHALL BE PROVIDED AT INLET AND AT THE BASE OF EACH CHECK DAM.
- ⑦ INSTALL ENERGY DISSIPATOR AT THE INLET OF VEGETATED SWALE.
- ⑧ SWALE LENGTH SHALL LENGTH REQUIRED TO PROVIDE 7 MINUTES RESIDENCE TIME.
- ⑨ INSTALL APPROPRIATE OUTLET STRUCTURE. ACCOMMODATE LOW FLOW CHANNEL AND/OR UNDERDRAIN (IF PRESENT).
- ⑩ AMEND SOILS WITH 2" OF COMPOST TILLED INTO 6" OF NATIVE SOIL UNLESS NATIVE SOIL ORGANIC CONTENT > 10%.
- ⑪ AFFIX PERMANENT IDENTIFICATION TAG AT INLET/OUTLET.



Figure 6-11: Vegetated Swale

Limitations

- 1) Compatibility with flood control - swales must not interfere with flood control functions of existing conveyance and detention structures.
- 2) Vegetation - select vegetation appropriately based on irrigation requirements and exposure (shady versus sunny areas). A thick vegetative cover is needed for vegetated swales to function properly.
- 3) Drainage area - each vegetated swale can treat a relatively small drainage area. Large areas should be divided and treated using multiple swales.

Design Criteria

Vegetated swales should be designed according to the requirements listed in Table 6-19 and outlined in the section below. BMP sizing worksheets are presented in Appendix E.

Table 6-19: Vegetated Swale Filter Design Criteria

Design Parameter	Unit	Design Criteria
Stormwater quality design flow rate (SQDF)	cfs	See Section 2 and Appendix E for calculating SQDF.
Swale Geometry	-	Trapezoidal
Minimum bottom width	feet	2
Maximum bottom width	feet	10; if greater than 10 must use swale dividers; with dividers, max is 16
Minimum length	feet	sufficient length to provide minimum contact time
Maximum channel side slope	H:V	4:1 (5:1 or flatter preferred)
Minimum slope in flow direction	%	0.2 (provide underdrains for slopes less < 0.5%)
Maximum slope in flow direction	%	2.0 (provide grade-control checks for slopes > 2.0)
Maximum flow velocity	ft/sec	1.0 (water quality treatment); 3.0 (flood conveyance)
Maximum depth of flow for water quality treatment	inches	3 to 5 (1 inch below top of grass)
Minimum residence (contact) time	minutes	7 (provide sufficient length to yield minimum residence time)
Vegetation type	--	Varies (see vegetation section below)
Vegetation height	inches	4 to 6 (trim or mow to maintain height)

Sizing Criteria

The flow capacity of a vegetated swale is a function of the longitudinal slope (parallel to flow), the resistance to flow (i.e. Manning's roughness), and the cross sectional area. The cross section is normally approximately trapezoidal and the area is a function of the bottom width and side slopes. The flow capacity of vegetated swales should be such that the SQDF will not exceed a flow depth of 2/3 the height of the vegetation within the swale or 4 inches at the SQDF. Once design criteria have been selected, the resulting flow depth for the SQDF is checked. If the depth restriction is exceeded, swale parameters (e.g. longitudinal slope, width) are adjusted to reduce the flow depth.

Procedures for sizing vegetated swales are summarized below. A vegetated swale sizing worksheet and example are also provided.

Step 1: Select design flows

The swale sizing is based on the SQDF (see [Section 2](#) and Appendix E).

Step 2: Calculate swale bottom width

The swale bottom width (b) is calculated based on Manning's equation for open-channel flow. This equation can be used to calculate discharges (Q) as follows:

$$Q = \frac{1.49AR^{1.67}S^{0.5}}{n} \quad \text{(Equation 6-17)}$$

Where:

Q	=	flow rate (cfs)
n	=	Manning's roughness coefficient (unitless)
A	=	cross-sectional area of flow (ft ²)
R	=	hydraulic radius (ft) = area divided by wetted perimeter
S	=	longitudinal slope (ft/ft)

For shallow flow depths in swales, channel side slopes are ignored in the calculation of bottom width. Use the following equation (a simplified form of Manning's formula) to estimate the swale bottom width (b):

$$b = \frac{SQDF * n_{wq}}{1.49y^{1.67}s^{0.5}} \quad \text{(Equation 6-18)}$$

Where:

b	=	bottom width of swale (ft)
----------	---	----------------------------

$SQDF$	=	stormwater quality design flow (cfs)
n_{wq}	=	Manning's roughness coefficient for shallow flow conditions = 0.2 (unitless)
y	=	design flow depth (ft)
s	=	longitudinal slope (along direction of flow) (ft/ft)

Proceed to Step 3 if the bottom width is calculated to be between 2 and 10 feet. A minimum 2-foot bottom width is required. Therefore, if the calculated bottom width is less than 2 feet, increase the width to 2 feet and recalculate the design flow depth y using the Equation 6-18, where $SQDF$, n_{wq} , and s are the same values as used above, but $b = 2$ feet.

The maximum allowable bottom width is 10 feet. Therefore, if the calculated bottom width exceeds 10 feet, then one of the following steps is necessary to reduce the design bottom width:

- 1) Increase the longitudinal slope (s) to a maximum of 2 feet in 100 feet (0.02 feet per foot).
- 2) Increase the design flow depth (y) to a maximum of 4 inches.
- 3) Place a divider lengthwise along the swale bottom (Figure 6-11) at least three-quarters of the swale length (beginning at the inlet), without compromising the design flow depth and swale lateral slope requirements. The swale width can be increased to an absolute maximum of 16 feet if a divider is provided.

Step 3: Determine design flow velocity

To calculate the design flow velocity (V_{wq}) through the swale, use the flow continuity equation:

$$V_{wq} = SQDF/A_{wq} \tag{Equation 6-19}$$

Where:

V_{wq}	=	design flow velocity (fps)
$SQDF$	=	stormwater quality design flow (cfs)
A_{wq}	=	$by + Zy^2$ = cross-sectional area (ft ²) of flow at design depth, where Z = side slope length per unit height (e.g., $Z = 3$ if side slopes are 3H:1V)

If the design flow velocity exceeds 1 foot per second, go back to Step 2 and modify one or more of the design parameters (longitudinal slope, bottom width, or flow depth) to reduce the design flow velocity to 1 foot per second or less. If the design flow velocity is calculated to be less than 1 foot per second, proceed to Step 4. *Note: It is desirable to*

have the design velocity as low as possible, both to improve treatment effectiveness and to reduce swale length requirements.

Step 4: Calculate swale length

Use the following equation to determine the necessary swale length (L) to achieve a hydraulic residence time of at least 10 minutes (600 seconds):

$$L = 60t_{hr}V_{wq} \tag{Equation 6-20}$$

Where:

- L = minimum allowable swale length (ft)
- t_{hr} = hydraulic residence time (min)
- V_{wq} = design flow velocity (fps), calculated by Equation 6-19

If there is adequate space on the site to accommodate a larger swale, consider using a greater length to increase the hydraulic residence time and improve the swale's pollutant removal capability. If the calculated length is too long for the site, or if it would cause layout problems, such as encroachment into shaded areas, proceed to Step 5 to further modify the layout. If the swale length can be accommodated on the site (meandering may help), proceed to Step 6.

Step 5: Adjust swale layout to fit on site

If the swale length calculated in Step 4 is too long for the site, the length can be reduced (to a minimum of 100 feet) by increasing the bottom width up to a maximum of 16 feet, as long as the 10 minute retention time is retained. However, the length cannot be increased in order to reduce the bottom width because Manning's depth-velocity-flow rate relationships would not be preserved. If the bottom width is increased to greater than 10 feet, a low flow dividing berm is needed to split the swale cross section in half to prevent channelization.

Length can be adjusted by calculating the top area of the swale and providing an equivalent top area with the adjusted dimensions.

- 1) Calculate the swale treatment top area (A_{top}), based on the swale length calculated in Step 4:

$$A_{top} = (b_i + b_{slope})L_i \tag{Equation 6-21}$$

Where:

- A_{top} = top area (ft²) at the design treatment depth
- b_i = bottom width (ft), calculated in Step 2 using Equation 6-18

b_{slope} = the additional top width (ft) above the side slope for the design water depth (for 3:1 side slopes and a 4-inch water depth, $b_{slope} = 2$ feet)

L_i = initial length (ft) calculated in Step 4 using Equation 6-20

- 2) Use the swale top area and a reduced swale length (L_f) to increase the bottom width, using the following equation:

$$L_f = A_{top} / (b_f + b_{slope}) \quad \text{(Equation 6-22)}$$

Where:

L_f = reduced swale length (ft)

b_f = increased bottom width (ft)

- 3) Recalculate V_{wq} according to Step 3 using the revised cross-sectional area A_{wq} based on the increased bottom width (b_f). Revise the design as necessary if the design flow velocity exceeds 1 foot per second.
- 4) Recalculate to ensure that the 10 minute retention time is retained.

Step 6: Provide conveyance capacity for flows higher than SQDF

Vegetated swales may be designed as flow-through channels that convey flows higher than the SQDF, or they may be designed to incorporate a high-flow bypass upstream of the swale inlet. A high-flow bypass usually results in a smaller swale size. If a high-flow bypass is provided, this step is not needed. If no high-flow bypass is provided, proceed with the procedure below. A flow splitter structure design is described in Appendix F.

- 1) Check the swale size to determine whether the swale can convey the flood control design storm peak flow (Refer to Ventura County Hydrology Manual, revised 2006).
- 2) The peak flow velocity of the flood control design storm (see Ventura County Hydrology Manual revised 2006) must be less than 3.0 feet per second. If this velocity exceeds 3.0 feet per second, return to Step 2 and increase the bottom width or flatten the longitudinal slope as necessary to reduce the flood control design storm peak flow velocity to 3.0 feet per second or less. If the longitudinal slope is flattened, the swale bottom width must be recalculated (Step 2) and must meet all design criteria.

Geometry and Size

- 1) In general, a trapezoidal channel shape shall be assumed for sizing calculations above, but a more naturalistic channel cross-section is preferred.

- 2) Swales designed for water quality treatment purposes only are usually fairly shallow, generally less than 1 ft. Therefore, a side slope of 2:1 (H:V) can be used and is acceptable.
- 3) Swales shall be greater than 100 feet in length. The vegetated swale can be shorter than 100 feet if it is used for pretreatment only (i.e., prior to infiltration). Length can be increased by meandering the swale.
- 4) The minimum swale bottom width shall be 2 feet to allow for ease of mowing.
- 5) The maximum swale bottom width shall be limited to 10 feet, unless a swale divider is provided, then the maximum bottom width can be a maximum of 16 feet wide. The swale width is calculated without the swale diving berm. *The intention is that experience shows that when the width exceeds about 10 feet, it is difficult to keep the water from concentrating in low flow channels. It is also difficult to construct the bottom level without sloping to one side. Vegetated swales are best constructed by leveling the bottom after excavating. A single-width pass with a front-end loader produces a better result than a multiple-width pass.*
- 6) Swales that are required to convey flood flow as well as the SQDF should be sized to convey the flood control design storm and include a provision of freeboard as required by the local approval authority.
- 7) Gradual meandering bends in the swale are desirable for aesthetic purposes and to promote slower flow.

Bottom Slope

- 1) The longitudinal slope (along the direction of flow) shall be between 1% and 6%.
- 2) If longitudinal slopes are less than 1.5% and the soils are poorly drained (e.g., silts and clays), then underdrains shall be provided. A soils report to verify soils properties shall be provided for swales less than 1.5%.
- 3) If longitudinal slope exceeds 2%, check dams with vertical drops of 12 inches or less shall be provided to achieve a bottom slope of 2% or less between the drop structures.
- 4) The lateral (horizontal) slope at the bottom of the swale shall be zero (flat) to discourage channeling.

Water Depth and Dry Weather Flow Drain

- 1) Water depth shall not exceed 4 inches (or 2/3 of the expected vegetation height), except for frequently mowed turf swales, in which the depth shall not exceed 2 inches.
- 2) The swale length must provide a minimum hydraulic residence time of 10 minutes.

- 3) A low flow drain shall be provided if the potential for dry weather flows exists. The low flow drain shall extend the entire length of the swale. The drain shall have a minimum depth of 6 inches, and a width no more than 5% of the calculated swale bottom width. The width of the drain shall be in addition to the required bottom width. The flow spreader at the swale inlet shall have v-notches (maximum top width = 5% of swale width) or holes to allow preferential exit of low flows into the drain, if applicable. If an underdrain or gravel drainage layer is installed as discussed below, the low flow drain shall be omitted.

Swale Inflow and Design Capacity

- 1) Whenever possible, inflow shall be directed towards the upstream end of the swale and shall, at a minimum, occur evenly over the length of the swale. Swale inflow design shall provide for positive drainage into the swale to function on the long-term with minimal maintenance.
- 2) On-line vegetated swales shall be designed to convey flow rates up to the post-development peak stormwater runoff discharge rate (flow rate) for the 100-yr 24-hour storm event, with appropriate freeboard (see Ventura County Hydrology Manual, revised 2006).
- 3) Off-line vegetated swales shall be designed to convey the flow-based SQDF by using a flow diversion structure (e.g., flow splitter) which diverts the SQDF to the off-line vegetated swale designed to handle SQDF. Freeboard for off-line swales is not required, but shall be provided if space is available. Flow splitter design specifications are described in Appendix F.

Energy Dissipation

- 1) Vegetated swales may be designed either on-line or off-line. If the facility is on-line, velocities shall be maintained below the maximum design flow velocity of 3 feet per second to prevent scour and resuspension of deposited sediments.
- 2) The maximum flow velocity under the stormwater quality design flow rate shall not exceed 1.0 foot per second. *The intention is that this maximum SQDV promotes settling and keeps vegetation upright.*
- 3) This velocity limitation combined with a maximum depth of 4 inches and bottom width of 10 feet results in a recommended maximum flow capacity of about 3.3 cfs, after accounting for the side slopes. The contributory drainage area to each swale is limited so as not to exceed this recommended maximum flow capacity.
- 4) The maximum flow velocity during the 100-yr 24-hr storm event shall not exceed 3.0 foot per second. This can be accomplished by:
 - a. Splitting roadside swales near high points in the road so that flows drain in opposite directions, mimicking flow patterns on the road surface.

- b. Limiting tributary areas to long swales by diverting flows throughout the length of the swale at regular intervals, to the downstream stormwater conveyance system.
- 5) A flow spreader (see “Flow Spreaders” below) shall be used at the inlet so that the entrance velocity is quickly dissipated and the flow is uniformly distributed across the whole swale. Energy dissipation controls shall be constructed of sound materials such as stones, concrete, or proprietary devices that are rated to withstand the energy of the influent flows.
- 6) If check dams are used to reduce the longitudinal slope, a flow spreader shall be provided at the toe of each vertical drop, with specifications described below.
- 7) If flow is to be introduced through curb cuts, place pavement approximately one inch above the elevation of the vegetated areas. Curb cuts shall be at least 12 inches wide to prevent clogging.

Flow Spreaders

- 1) An anchored plate flow spreader or similar device shall be provided at the inlet to the swale. Equivalent methods for spreading flows evenly throughout the width of the swale are acceptable.
- 2) The top surface of the flow spreader plate shall be level, projecting a minimum of 2 inches above the ground surface of the water quality facility, or v-notched with notches 6 to 10 inches on center and 1 to 4 inches deep (use shallower notches with closer spacing).
- 3) A flow spreader plate shall extend horizontally beyond the bottom width of the facility to prevent water from eroding the side slope. The plate shall have a row of horizontal perforations at its base to prevent ponding for long durations. The horizontal extent shall be such that the bank is protected for all flows up to the 100-yr 24-hr storm event (on-line swales) or the maximum flow that will enter the water quality facility (off-line swales).
- 4) Flow spreader plates shall be securely fixed in place.
- 5) Flow spreader plates may be made of either concrete, stainless steel, or other durable material.
- 6) Anchor posts shall be 4-inch square concrete, tubular stainless steel, or other material resistant to decay.

Check Dams

If check dams are required, they can be designed using a number of different materials, including riprap, earthen berms, or removal stop logs. Check dams must be placed as to achieve the desired slope (1 to 6%) at a maximum of 50 feet apart. Check dams shall be

no higher than 12 inches. If riprap is used, the material shall consist of well-graded stone consisting of a mixture of rock sizes. The following is an example of an acceptable gradation:

Particle Size	% Passing
24 inch	100
15 inch	75
9 inch	50
4 inch	10

Underdrains

If underdrains (not to be confused with a dry weather flow drain) are required, then they must meet the following criteria:

- 1) Underdrains must be made of slotted, polyvinyl chloride (PVC) pipe (PVC SDR 35 or approved equivalent). *The intention is that in comparison to round-hole perforated pipe, slotted underdrains provide greater intake capacity, clog resistant drainage, and reduced entrance velocity into the pipe, thereby reducing the chances of solids migration.*
- 2) Slotted pipe shall have 2 to 4 rows of slots cut perpendicular to the axis of the pipe or at right angles to the pitch of corrugations. Slots shall be 0.04 to 0.1 inch and shall have a length of 1 to 1.25 inches. Slots shall be longitudinally spaced such that the pipe has a minimum of one square inch of opening per linear foot of pipe.
- 3) Underdrains shall be sloped at a minimum of 0.5%.
- 4) The underdrain pipe must be 6 inches or greater in diameter, so it can be cleaned without damage to the pipe. Clean-out risers with diameters equal to the underdrain pipe must be placed at the terminal ends of the underdrain and can be incorporated into the flow spreader and outlet structure to minimize maintenance obstacles in the swale. Intermediate clean-out risers may also be placed in the check dams or grade control structures. The cleanout risers shall be capped with a lockable screw cap.
- 5) The underdrain shall be placed parallel to the swale bottom and backfilled and underbedded with six inches of drain rock. The following coarse aggregate shall be used to provide a gravel blanket and bedding for the underdrain pipe to provide a 1 foot minimum depth around the top and sides of the slotted pipe.

Sieve size	Percent Passing
¾ inch	100
¼ inch	30-60
US No. 8	20-50
US No. 50	3-12
US No. 200	0-1

- 6) At the option of the designer/geotechnical engineer, the drain rock may be wrapped in a geotextile fabric meeting the following minimum materials requirements. If a geotextile fabric is used, it must pass 75 gal/min/ft², should not impede the infiltration rate of the soil medium, and must meet the following minimum materials requirements.

Geotextile Property	Value	Test Method
Trapezoidal Tear (lbs)	40 (min)	ASTM D4533
Permeability (cm/sec)	0.2 (min)	ASTM D4491
AOS (sieve size)	#60 - #70 (min)	ASTM D4751
Ultraviolet resistance	70% or greater	ASTM D4355

Preferably, aggregate should be used in place of geotextile fabric to reduce the potential for clogging. This aggregate layer should consist of 2 to 4 inches of washed sand underlain with 2 inches of choking stone (Typically #8 or #89 washed).

- 7) The underdrain must drain freely to an acceptable discharge point. The underdrain can be connected to a downstream open conveyance (vegetated swale), to another bioretention cell as part of a connected treatment system, daylight to a vegetated dispersion area using an effective flow dispersion device, stored for reuse, or to a storm drain.

Gravel Drainage Layer

To increase volume reduction and if soil conditions allow (infiltration rate > 0.5 in/hr), omit the low flow drain or underdrain and install an appropriately sized gravel drainage layer (typically a washed 57 stone) beneath the swale to achieve desired volume reduction goals. Where slopes are greater than 1%, the gravel drainage layer shall be installed in combination with check dams (e.g., drop structures) to slow the flow in the swale and allow for infiltration into the gravel drainage layer and then into the subsurface. The base of the drainage layer shall have zero slope. The drawdown time in the gravel drainage layer shall not exceed 72 hours. The soil and gravel layers shall be separated with a geotextile filter fabric or a thin, 2 to 4 inch layer of pure sand and a thin layer (nominally two inches) of choking stone (such as #8). Sizing of the gravel drainage layer is based on volume reduction requirements.

Swale Divider

- 1) If a swale divider is used, the divider shall be constructed of a firm material that will resist weathering and not erode, such as concrete, plastic, or compacted soil seeded with grass. Treated timber shall not be used. Selection of divider material must take into account maintenance activities, such as mowing.
- 2) The divider must have a minimum height of 1 inch greater than the stormwater quality design water depth.


- 3) Earthen berms shall be no steeper than 2H:1V.
- 4) Material other than earth shall be embedded to a depth sufficient to be stable.

Soils

Swale soils shall be amended with 2 inches of compost, unless the organic content is already greater than 10%. The compost shall be mixed into the native soils to a depth of 6 inches to prevent soil layering and washout of compost. The compost will contain no sawdust, green or under-composted material, or any other toxic or harmful substance. It shall contain no un-sterilized manure, which can lead to high levels of pathogen indicators (coliform bacteria) in the runoff.

Vegetation

Swales must be vegetated in order to provide adequate treatment of runoff via filtration. Vegetation, when chosen and maintained appropriately, also improves the aesthetics of a site. It is important to maximize water contact with vegetation and the soil surface.

- 1) The swale area shall be appropriately vegetated with a mix of erosion-resistant plant species that effectively bind the soil. A diverse selection of low growing plants that thrive under the specific site, climatic, and watering conditions shall be specified. A mixture of dry-area and wet-area grass species that can continue to grow through silt deposits is most effective. Native or adapted grasses are preferred because they generally require less fertilizer, limited maintenance, and are more drought-resistant than exotic plants. When appropriate, swales that are integrated within a project may use turf or other more intensive landscaping, while swales that are located on the project perimeter, within a park, or close to an open space area are encouraged to be planted with a more naturalistic plant palette.
- 2) Trees or shrubs may be used in the landscape as long as they do not over-shade the turf. 
- 3) Above the design treatment elevation, a typical lawn mix or landscape plants can be used provided they do not shade the swale vegetation.
- 4) Irrigation is required if the seed is planted in the spring or summer. Use of a permanent irrigation system may help provide maximal water quality performance. Drought-tolerant grasses shall be specified to minimize irrigation requirements.
- 5) Vegetative cover shall be at least 4 inches in height, ideally 6 inches. Swale water depth shall ideally be 2/3 of the height of the shortest plant species.
- 6) Locate the swale in an area without excessive shade to avoid poor vegetative growth. For moderately shaded areas, shade tolerant plants shall be used.
- 7) Locate the swale away from large trees that may drop excessive leaves or needles, which may smother the grass or impede the flow through the swale. Landscape

planter beds should be designed and located so that soil does not erode from the beds and enter a nearby swale.

Maintenance Access

- 1) Access to the swale inlet and outlet shall be safely provided, with ample room for maintenance and operational activities.

Operations and Maintenance

- 1) Inspect vegetated swales for erosion or damage to vegetation after every storm greater than 0.75 inches for on-line swales and at least twice annually for off-line swales, preferably at the end of the wet season to schedule summer maintenance and in the fall to ensure readiness for winter. Additional inspection after periods of heavy runoff is recommended. Each swale should be checked for debris and litter and areas of sediment accumulation (see Appendix I for a vegetated swale inspection and maintenance checklist).
- 2) Swale inlets (curb cuts or pipes) should maintain a calm flow of water entering the swale. Remove sediment as needed at the inlet, if vegetation growth is inhibited in greater than 10% of the swale or if the sediment is blocking even distribution and entry of the water. Following sediment removal activities, replanting and/or reseedling of vegetation may be required for reestablishment.
- 3) Flow spreaders should provide even dispersion of flows across the swale. Sediments and debris should be removed from the flow spreader if blocking flows. Splash pads should be repaired if needed to prevent erosion. Spreader level should be checked and leveled if necessary.
- 4) Side slopes should be maintained to prevent erosion that introduces sediment into the swale. Slopes should be stabilized and planted using appropriate erosion control measures when native soil is exposed or erosion channels are formed.
- 5) Swales should drain within 48 hours of the end of a storm. Till the swale if compaction or clogging occurs and revegetate. If a perforated underdrain pipe is present, it should be cleaned if necessary.
- 6) Vegetation should be healthy and dense enough to provide filtering, while protecting underlying soils from erosion:
 - Mulch should be replenished as needed to ensure survival of vegetation.
 - Vegetation, large shrubs or trees that interfere with landscape swale operation should be pruned.
 - Fallen leaves and debris from deciduous plant foliage should be removed.

- Grassy swales should be mowed to 4 to 6 inches height. Grass clippings shall be removed.
 - Invasive vegetation, such as Alligatorweed (*Alternanthera philoxeroides*), Halogeton (*Halogeton glomeratus*), Spotted Knapweed (*Centaurea maculosa*), Giant Reed (*Arundo donax*), Castor Bean (*Ricinus communis*), Perennial Pepperweed (*Lepidium latifolium*), and Yellow Starthistle (*Centaurea solstitialis*) must be removed and replaced with non-invasive species. Invasive species should never contribute more than 10% of the vegetated area. For more information on invasive weeds, including biology and control of listed weeds, look at the “encycloweedia” located at the California Department of Food and Agriculture website at <http://www.cdfa.ca.gov/wma> or the California Invasive Plant Council website at <http://portal.cal-ipc.org/weedlist>.
 - Dead vegetation should be removed if greater than 10% of area coverage or when swale function is impaired. Vegetation should be replaced and established before the wet season to maintain cover density and control erosion where soils are exposed.
- 7) Check dams (if present) should control and distribute flow across the swale. Causes for altered water flow and/or channelization should be identified and obstructions cleared. Check dams and swale should be repaired if damaged.
- 8) The vegetated swale should be well maintained. Trash and debris, sediment, visual contamination (e.g., oils), noxious or nuisance weeds, should all be removed.

BIO-4: Vegetated Filter Strip

Filter strips are vegetated areas designed to treat sheet flow runoff from adjacent impervious surfaces or intensive landscaped areas such as golf courses. Filter strips decrease runoff velocity, filter out total suspended solids and associated pollutants, and provide some infiltration into underlying soils. While some assimilation of dissolved constituents may occur, filter strips are generally more effective in trapping sediment and particulate-bound metals, nutrients, and pesticides. Filter strips are more effective when the runoff passes through the vegetation and thatch layer in the form of shallow, uniform flow. Biological and chemical processes may help break down pesticides, uptake metals, and use nutrients that are trapped in the filter.



Vegetated filter strip captures runoff from freeway

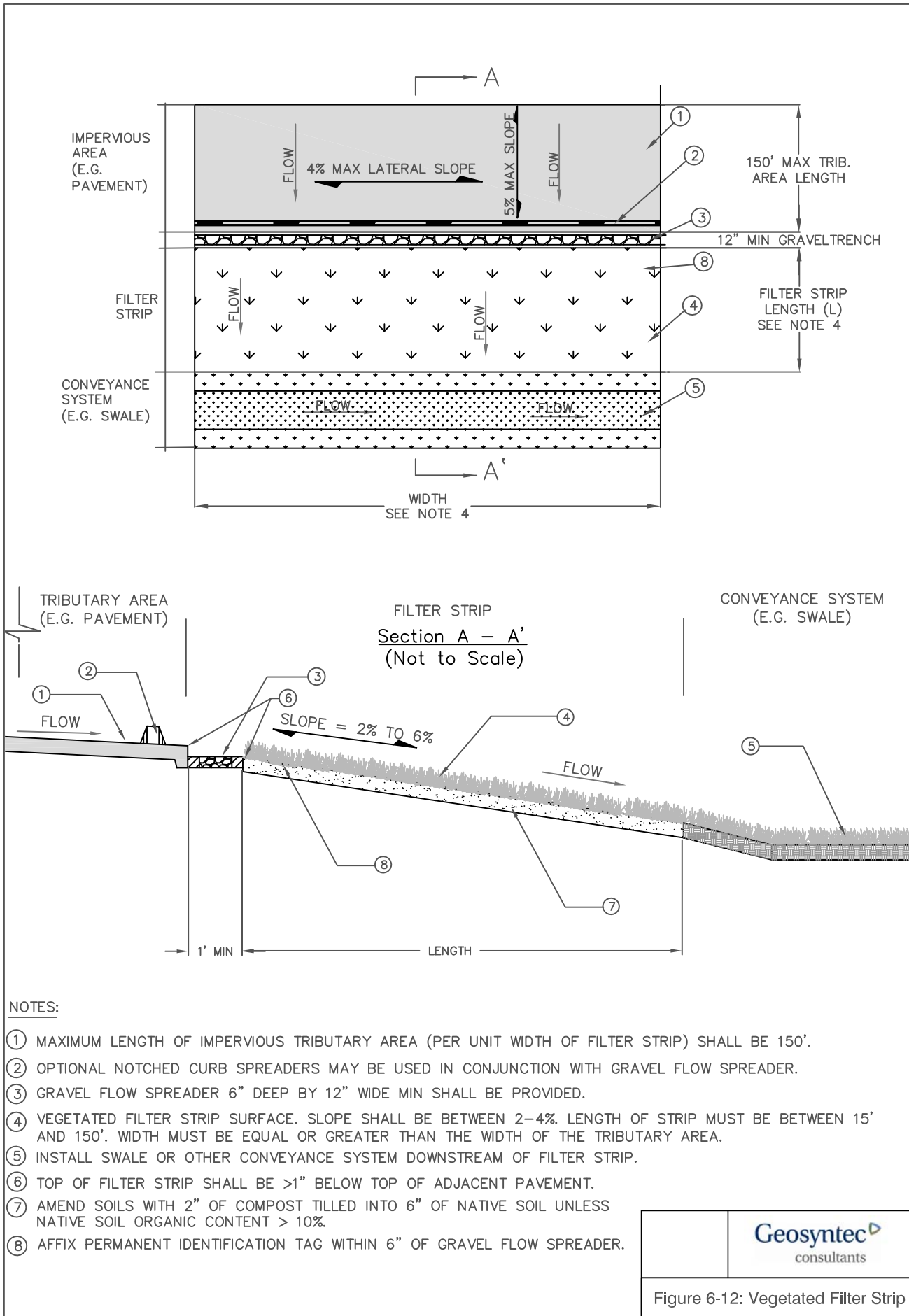
Photo Credit: Washington Department of Transportation

Applications

- Areas adjacent to parking lots and driveways
- Road medians and shoulders

Preventative Maintenance

- Remove excess sediment
- Stabilize/repair minor erosion and scouring
- Remove trash and debris
- Mow regularly



Limitations

The following describes limitations for vegetated filter strips:

- High flow velocity - steep terrain and/or large tributary area may cause concentrated, erosive flows.
- Sheet flow - shallow, evenly-distributed flow across the entire width of the filter strip is required. Filter strips are designed to treat small areas. The maximum flow path from a contributing impervious surface should not exceed 150 feet. Flows must enter as sheet flow and not exceed a depth of 1 inch.
- Shallow grades – a limited site slope may cause ponding.
- Availability of pervious area adjacent to impervious area - filter strips require sheet flow from impervious areas.

Design Criteria

The main challenge associated with filter strips is maintaining sheet flow, which is critical to the performance of this BMP. If flows are concentrated, then little or no treatment of stormwater runoff is achieved and erosive rilling is likely. The use of a flow spreading device (e.g., gravel trench or level spreader) to deliver shallow, evenly-distributed sheet flow to the strip is required. Vegetated filter strips should be designed according to the requirements listed in Table 6-20 and outlined in the section below. BMP sizing worksheets are presented in Appendix E.

Table 6-20: Vegetated Filter Strip Design Criteria

Design Parameter	Unit	Design Criteria
Stormwater quality design flow (SQDF)	cfs	See Section 2 and Appendix E for calculating SQDF.
Maximum design flow depth	inches	1
Design residence time	minutes	10
Design flow velocity	ft/sec	< 1 ft/sec
Minimum length in flow direction	feet	15 (25 preferred); If sized for pretreatment only, filter strip can be a minimum of 4.
Maximum length (parallel to flow) of tributary area per unit width (perpendicular to flow) of filter strip	feet	150
Minimum slope in flow direction	%	2
Maximum slope in flow direction	%	4
Maximum lateral slope	%	4
Vegetation	-	Turf grass (irrigated) or approved equal
Minimum grass height	inches	2
Maximum grass height	inches	4 (typical) or as required to prevent shading
Elevation of flow spreader	inches	> 1 inch below the pavement surface

Sizing Criteria

The flow capacity of a vegetated filter strips (filter strips) is a function of the longitudinal slope (parallel to flow), the resistance to flow (e.g., Manning’s roughness), and the width and length of the filter strip. The slope shall be shallow enough to ensure that the depth of water will not exceed 1 inch over the filter strip. Similarly, the flow velocity shall be less than 1 ft/sec. Procedures for sizing filter strips are summarized below. A filter strip sizing example is also provided.

Step 1: Calculate the design flow rate

The design flow is calculated based on the SQDF (see Section 2).

Step 2: Calculate the minimum width

Determine the minimum width (W_{min}), perpendicular to flow, allowable for the filter strip and design for that width or larger.

$$W_{min} = (SQDF) / (q_{a,min}) \quad \text{(Equation 6-23)}$$

Where

- W_{min} = minimum width of filter strip (and tributary area)
- $SQDF$ = design flow (cfs)
- $q_{a,min}$ = minimum linear unit application rate, 0.005 cfs/ft

Step 3: Calculate the design flow depth

The design flow depth (d_f) is calculated based on the width and the slope, parallel to the flow path, using a modified Manning's equation as follows:

$$d_f = 12 \times [SQDF * n_{wq} / 1.49W_{trib}s^{0.5}]^{0.6} \quad \text{(Equation 6-24)}$$

Where:

- d_f = design flow depth (inches)
- $SQDF$ = design flow (cfs)
- W = width of strip (perpendicular to flow = width of impervious surface contributing area (ft))
- s = slope (ft/ft) of strip parallel to flow, average over the whole width
- n_{wq} = Manning's roughness coefficient (0.25-0.30)

If d_f is greater than 1 inch (0.083 ft), then a shallower slope is required, or a filter strip cannot be used.

Step 4: Calculate the design velocity

The design flow velocity (V_{wq}) is based on the design flow, design flow depth, and width of the strip:

$$V_{wq} = SQDF / (d_f W) \quad \text{(Equation 6-25)}$$

Where:

- $d_{f,ft}$ = design flow depth (ft) ($d_f/12$)
- $SQDF$ = stormwater quality design flow (cfs)

W = width of strip (perpendicular to flow = width of impervious surface contributing area (ft))

Step 5: Calculate the desired length of the filter strip

Determine the required length (L) to achieve a desired minimum residence time of 10 minutes using:

$$L = 60t_{hr} * V_{wq} \quad \text{(Equation 6-26)}$$

Where:

L = minimum allowable strip length (ft)

t_{hr} = hydraulic residence time (min)

V_{wq} = design flow velocity (fps) calculated by Equation 6-25

Geometry and Size

- 1) The width of the filter strip shall extend across the full width of the tributary area. The upstream boundary of the filter shall be located contiguous to the developed tributary area.
- 2) The length (in direction of flow) shall be between 15 and 150 feet. A minimum length of 25 feet is preferred. Filter strips used for pretreatment shall be at least 4 feet long (in direction of flow).
- 3) Filter strips shall be designed on slopes (parallel to the direction of flow) between 2% and 4%; steeper slopes tend to result in concentrated flow. Slopes less than 2% could pond runoff, and in poorly permeable soils, create a mosquito breeding habitat.
- 4) The lateral slope of strip (parallel to the edge of the pavement, perpendicular to the direction of flow) shall be 4% or less.
- 5) Grading shall be even: a filter strip with uneven grading perpendicular to the flow path will develop flow channels over time.
- 6) The top of the strip shall be installed 2 to 5 inches below the adjacent pavement to allow for vegetation and sediment accumulation at the edge of the strip. A beveled transition is acceptable and may be required per roadside design specifications.
- 7) Both the top and toe of the slope shall be as flat as possible to encourage sheet flow and prevent channeling and erosion. For engineered filter strips, the facility surface shall be graded flat prior to placement of vegetation.

Energy Dissipation / Level Spreading

Runoff entering a filter strip must not be concentrated. A flow spreader shall be installed at the edge of the pavement to uniformly distribute the flow along the entire width of the filter strip.

- 1) At a minimum, a gravel flow spreader (gravel-filled trench) shall be placed between the impervious area contributing flows and the filter strip, and meet the following requirements:
 - a. The gravel flow spreader shall be a minimum of 6 inches deep and shall be 12 inches wide.
 - b. The gravel shall be a minimum of 1 inch below the pavement surface. *The intention is that this allows sediment from the paved surface to be accommodated without blocking drainage onto the strip.*
- 2) The gravel flow spreader shall be a minimum of 6 inches deep and shall be 12 inches wide.
 - a. Where the ground surface is not level, the gravel spreader must be installed so that the bottom of the gravel trench and the outlet lip are level.
 - b. Along roadways, gravel flow spreaders must be placed and designed in accordance with County road design specifications for compacted road shoulders.
- 3) Curb ports and interrupted curbs may only be used in conjunction with a gravel spreader to better ensure that water sheet flows onto the strip, provided:
 - a. Curb ports use fabricated openings that allow concrete curbing to be poured or extruded while still providing an opening through the curb to admit water to the filter strip. Interrupted curbs are sections of curb placed to have gaps spaced at regular intervals along the total width of the treatment area. Openings or gaps in the curb shall be at regular intervals but at least every 6 feet. The width of each opening shall be a minimum of 11 inches.
 - b. At a minimum, gaps shall be every 6 feet to allow distribution of flows into the treatment facility before they become too concentrated. The opening shall be a minimum of 11 inches. Approximately 15 percent or more of the curb section length shall be in open ports, and as a general rule, no opening shall discharge more than 10 percent of the overall flow entering the facility.
- 4) Energy dissipaters are needed in a filter strips if sudden slope drops occur, such as locations where flows in a filter strip pass over a rockery or retaining wall aligned perpendicular to the direction of flow. Adequate energy dissipation at the base of a drop section can be provided by a riprap pad.

Access

- 1) Access shall be provided at the upper edge of a filter strip to enable maintenance of the inflow spreader throughout the strip width and allow access for mowing equipment.

Water Depth and Velocity

- 1) The design water depth shall not exceed 1 inch.
- 2) Runoff flow velocities shall not exceed approximately 1 foot per second across the filter strip surface.

Soils

Filter strip soils shall be amended with 2 inches of compost, unless the organic content is already greater than 10%. The compost shall be mixed into the native soils to a depth of 6 inches to prevent soil layering and washout of compost. The compost will contain no sawdust, green or under-composted material, or any other toxic or harmful substance. It shall contain no un-sterilized manure which can lead to high levels of potentially pathogenic bacteria in the runoff.

Vegetation

Filter strips must be uniformly graded and densely vegetated with erosion-resistant grasses that effectively bind the soil. Native or adapted grasses are preferred because they generally require less fertilizer and are more drought-resistant than exotic plants. The following vegetation guidelines shall be followed for filter strips:

- 1) Sod (turf) can be used instead of grass seed, as long as there is complete coverage.
- 2) Irrigation shall be provided to establish the grasses.
- 3) Grasses or turf shall be maintained at a height of 2 to 4 inches. Regular mowing is often required to maintain the turf grass cover.
- 4) Trees or shrubs shall not be used in abundance because they shade the turf and impede sheet flow.

Operations and Maintenance

Filter strips mainly require vegetation management. Therefore little special training is needed for maintenance crews. Typical maintenance activities and frequencies include:

- 1) Inspect strips at least twice annually for erosion or damage to vegetation, preferably at the end of the wet season to schedule summer maintenance and in the fall to ensure the strip is ready for winter. However, additional inspection after periods of heavy runoff is most desirable. The strip should be checked for debris and litter and

- areas of sediment accumulation (see Appendix I for a vegetated filter strip inspection and maintenance checklist).
- 2) Mow as frequently as necessary (at least twice a year) for safety and aesthetics or to suppress weeds and woody vegetation.
 - 3) Trash tends to accumulate in strip areas, particularly along roadways. The need for litter removal should be determined through periodic inspection. Litter should always be removed prior to mowing.
 - 4) Regularly inspect vegetated buffer strips for pools of standing water. Vegetated filter strips can become a nuisance due to mosquito breeding in level spreaders (unless designed to dewater completely in less than 72 hours), in pools of standing water if obstructions develop (e.g. debris accumulation, invasive vegetation), and/or if proper drainage slopes are not implemented and maintained.
 - 5) Activities that lead to ruts or depressions on the surface of the filter strip shall be prevented or the integrity of the strip shall be restored by leveling and reseeding. Examples are vehicle tracks, utility maintenance, and pedestrian (short-cut) tracks.

BIO-5: Proprietary Biotreatment

Proprietary biotreatment devices are manufactured treatment BMPs that incorporate plants, soil, and microbes engineered to provide treatment at higher flow rates or volumes and with smaller footprints than their non-proprietary counterparts. Incoming flows are typically pretreated to remove larger particles/debris, filtered through a planting media (mulch, compost, soil, and plants), collected by an underdrain, and delivered to the stormwater conveyance system.



Application

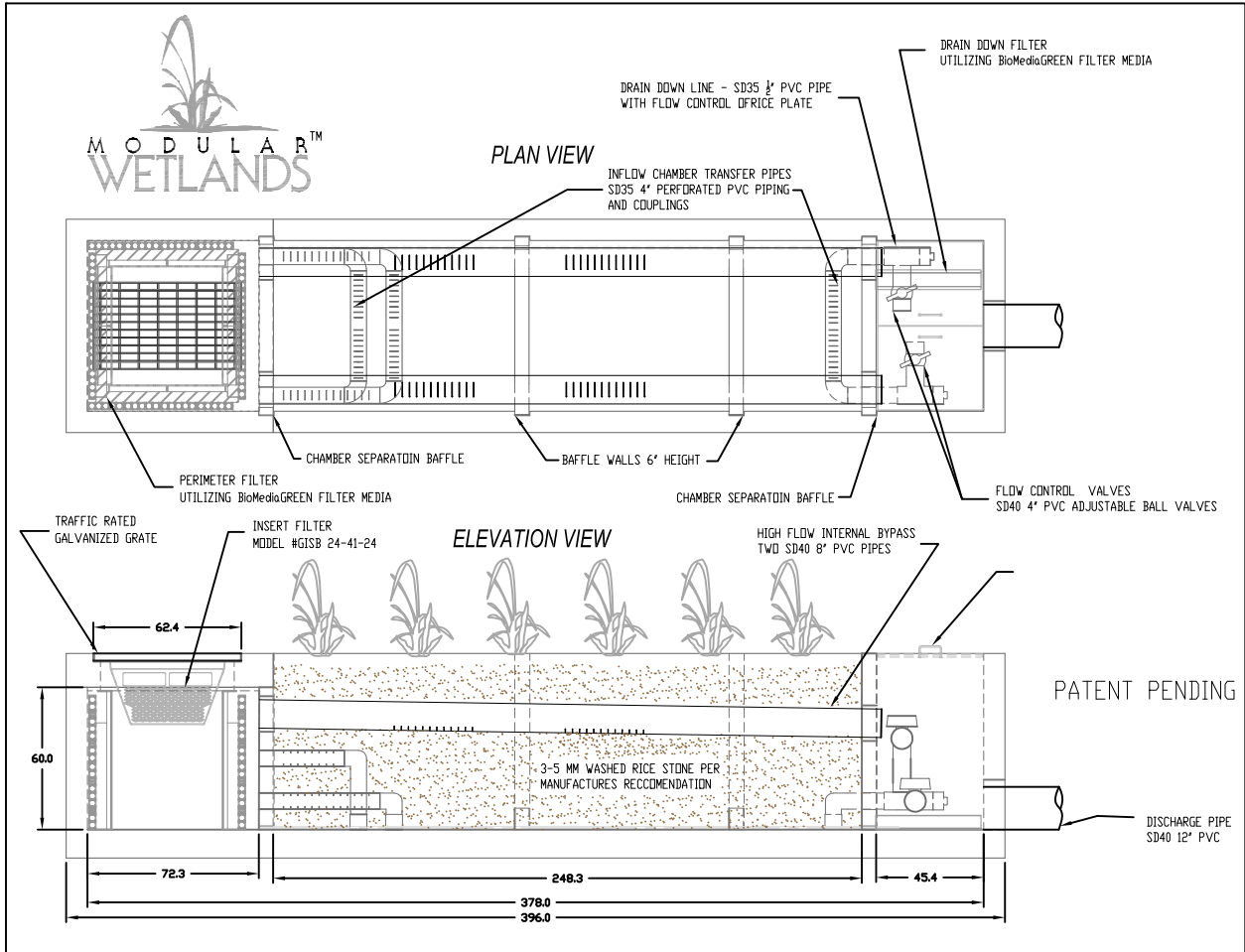
- Parking lot islands
- Pickup/drop off turnarounds
- Roadway curbs

Maintenance

- Filter media replacement
- Sediment, trash, and debris removal
- Mulch replacement
- Vegetation upkeep and replacement

Proprietary Biotreatment Examples

Photo Credits: 1. Filterra®; 2. Stormtreat™



STORMTREAT™ SYSTEMS, Inc.

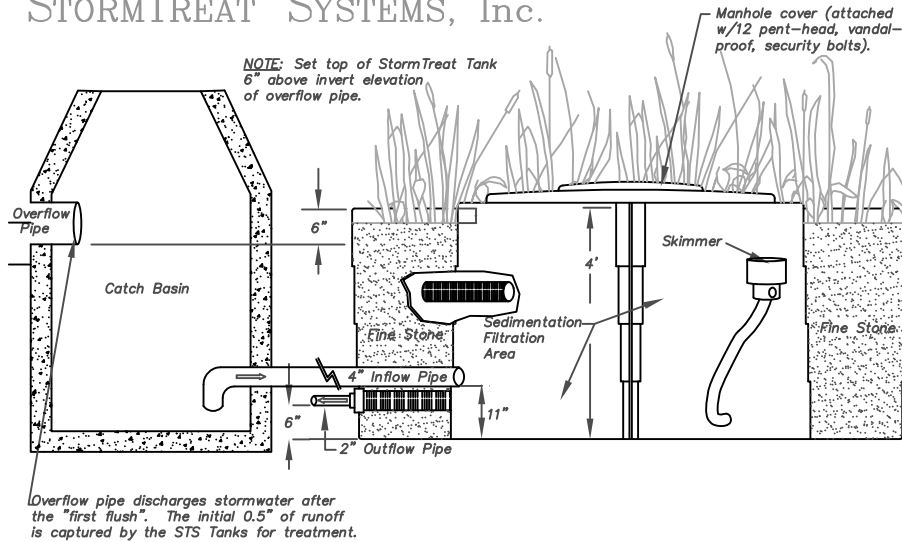


Figure 6-13: Biotreatment Device

Table 6-21: Proprietary Biotreatment Device Manufacturer Websites

Device	Manufacturer	Website
DeepRoot® Silva Cell	DeepRoot® Urban Landscape Products	www.deeproot.com
Filtterra®	Filtterra® Bioretention Systems	www.filtterra.com
Modular Wetlands (MWS-LINEAR)	Modular Wetlands Systems Inc.	www.modularwetlands.com
StormTreat™	StormTreat Systems Inc.	www.stormtreat.com

Design Criteria

As proprietary biotreatment BMP vendors are constantly updating and expanding their product lines, refer to the specific vendor for the latest design and sizing guidance.

TCM-1: Dry Extended Detention Basin

Dry extended detention (ED) basins are basins whose outlets have been designed to detain the SQDV for 36 to 48 hours to allow sediment particles and associated pollutants to settle and be removed. Dry ED basins do not have a permanent pool. They are designed to drain completely between storm events. They can also be used to provide hydromodification and/or flood control by modifying the outlet control structure and providing additional detention storage. The slopes, bottom, and forebay of dry ED basins are typically vegetated. Without the addition of a sand filter beneath the basin, considerable stormwater volume reduction can still occur, depending on the infiltration capacity of the subsoil.



Extended Detention Basin Application

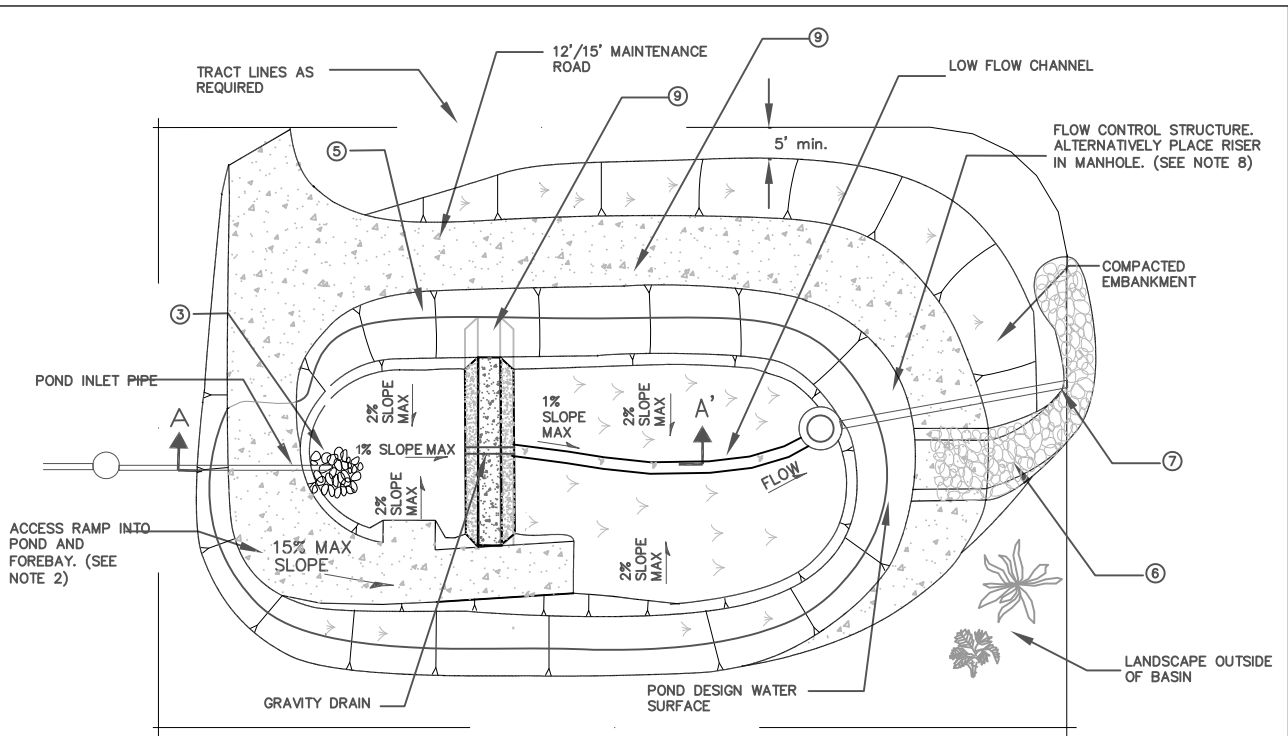
Photo Credit: Geosyntec Consultants

Application

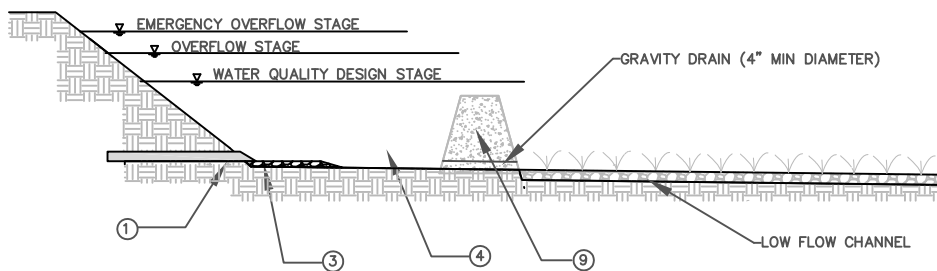
- Adjacent to parking lots
- Road medians and shoulders
- Within open areas or play fields

Preventative Maintenance

- Remove trash and debris, minor sediment accumulation, and obstructions near inlet and outlet structures
- Replace top 2 to 4 inch of sand
- Mow or weed surface of filter



Plan View
(Not to Scale)



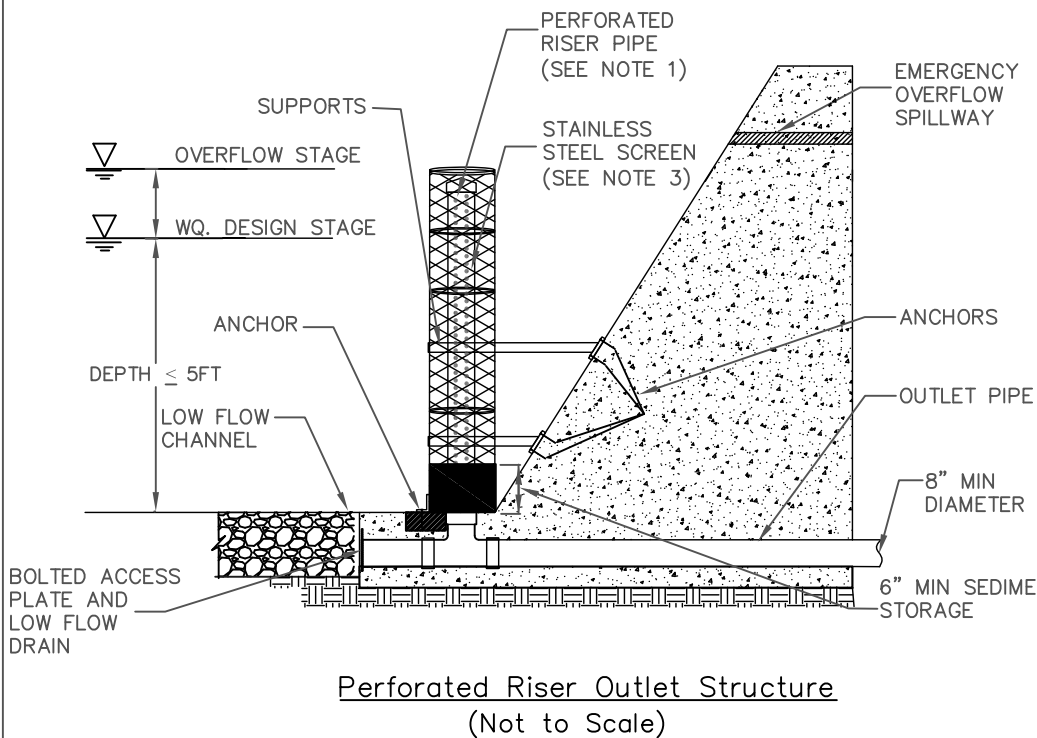
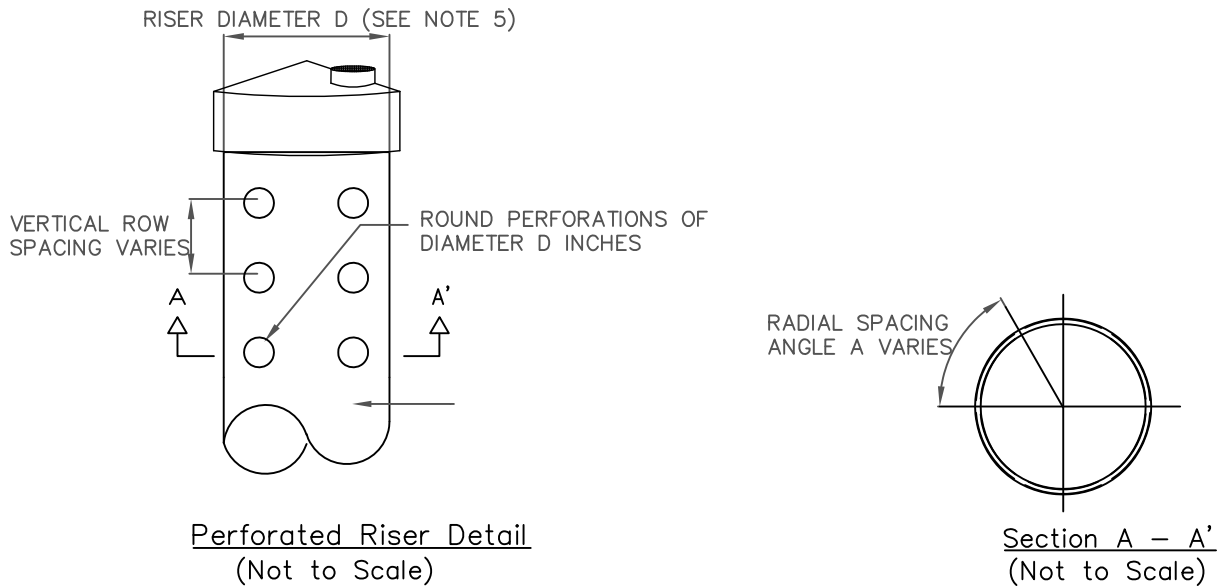
Section A - A'
(Not to Scale)

NOTES:

- ① INLET PIPE SHALL BE DESIGNED AND LOCATED SO THAT NON-EROSIVE VELOCITIES OCCUR IN THE FOREBAY
- ② MAINTENANCE RAMP SHOULD BE PAVED. SLOPE SHOULD NOT EXCEED 10H:1V. MAINTENANCE RAMP SHOULD PROVIDE ACCESS TO BOTH THE FOREBAY AND MAIN BASIN.
- ③ RIP RAP APRON OR OTHER INLET ENERGY DISSIPATION SHALL BE PROVIDED SUCH THAT VELOCITIES IN THE FOREBAY ARE < 4 FT/S.
- ④ SEDIMENT FOREBAY SHOULD BE SIZED TO PROVIDE 5-15% OF THE TOTAL BASIN VOLUME.
- ⑤ SIDE SLOPES SHOULD NOT EXCEED 3:1 (4:1 INTERIOR) UNLESS APPROVED BY AN ENGINEER.
- ⑥ EMERGENCY SPILLWAY MUST BE SIZED TO PASS CAPITAL DEVELOPMENT PEAK FLOW FOR ON-LINE BASINS, AND WATER QUALITY DESIGN FLOW FOR OFF-LINE BASINS.
- ⑦ OUTLET PIPE. ENERGY DISSIPATION SHALL BE PROVIDED UNLESS DISCHARGE IS TO PIPE OR HARDENED CHANNEL.
- ⑧ OUTLET STRUCTURE SHOULD BE SIZED TO DRAIN WATER QUALITY VOLUME IN 36 - 48 HOURS (SEE FIGURE 2-2 FOR PERFORATED RISER DETAILS). ALTERNATIVELY PLACE RISER STRUCTURE IN A MANHOLE (SEE FIGURE 2-3).
- ⑨ INSTALL EARTHEN BERM OR EQUIVALENT. TOP OF BERM SHALL BE 2' MINIMUM BELOW DESIGN WATER QUALITY STAGE. BERM SHALL BE KEYED INTO EMBANKMENT A MINIMUM OF 1' ON BOTH SIDES.

Geosyntec
consultants

Figure 6-14: Extended Detention Basin

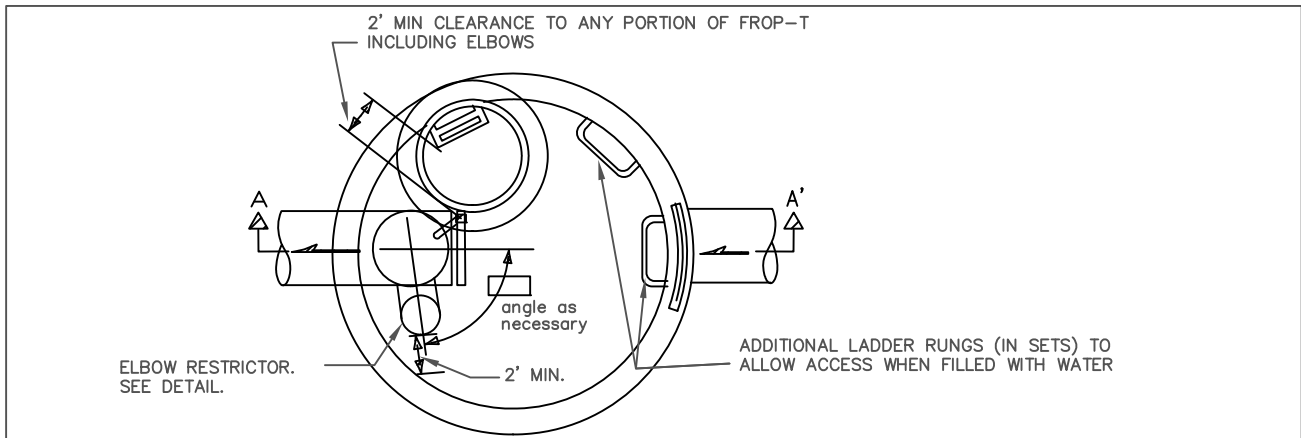


NOTES:

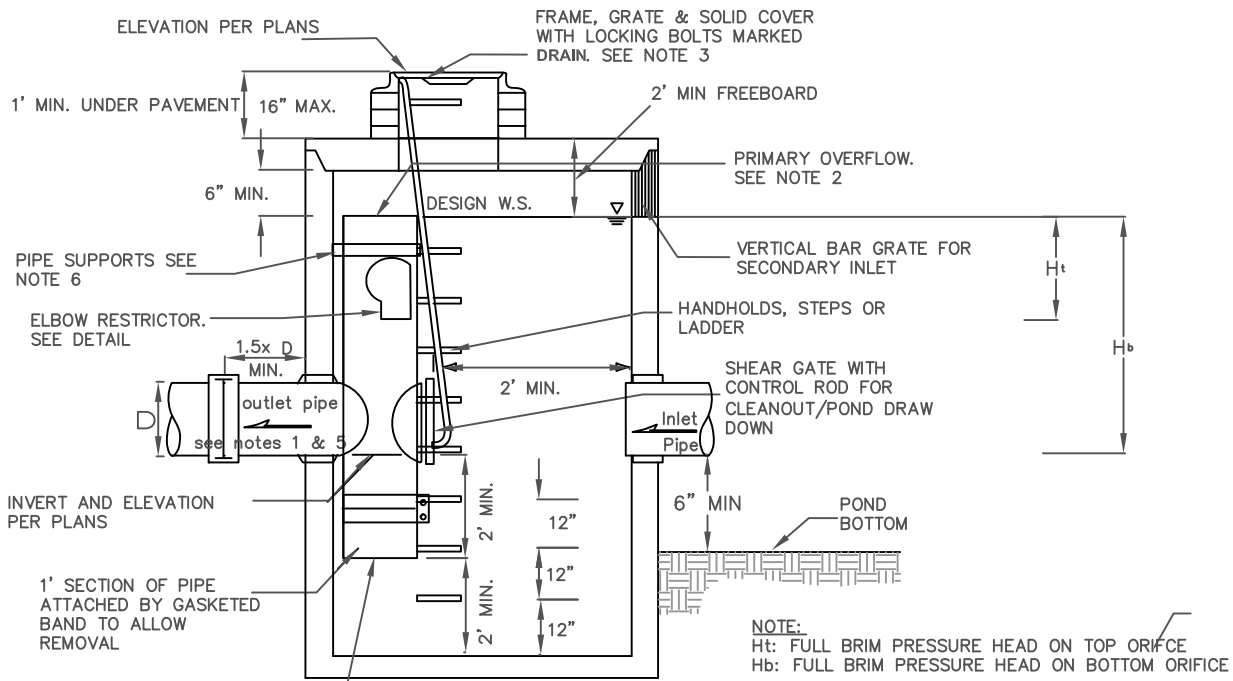
- ① RISER PIPE SHALL BE SIZED TO PROVIDE 36 TO 48-HOUR FULL BRIM DRAW DOWN TIME.
- ② TOTAL OUTLET CAPACITY: CAPITAL DEVELOPED PEAK FLOW FOR ON-LINE BASINS AND WATER QUALITY DESIGN FLOW FOR OFF-LINE BASINS.
- ③ SCREEN OPENINGS SHALL BE AT LEAST 1/4" AND SHALL NOT EXCEED THE DIAMETER OF THE PERFORATIONS ON THE RISER.
- ④ RISER PIPE PERFORATION DIAMETER SHALL BE NO LESS THAN 1/2" AND NO MORE THAN 2"
- ⑤ MINIMUM PIPE DIAMETER (D) IS 2'
- ⑥ RISER PIPE MATERIAL IS CMP



Figure 6-15: Perforated Riser Outlet

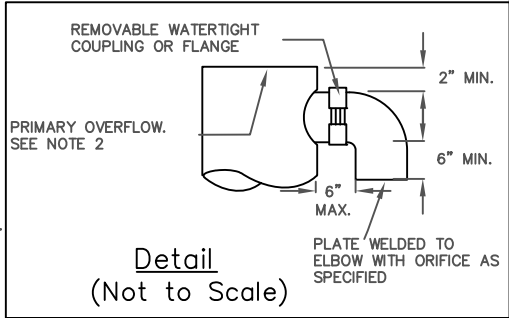


Plan View
(Not to Scale)



Section A - A'
(Not to Scale)

NOTE:
Ht: FULL BRIM PRESSURE HEAD ON TOP ORIFICE
Hb: FULL BRIM PRESSURE HEAD ON BOTTOM ORIFICE



Detail
(Not to Scale)

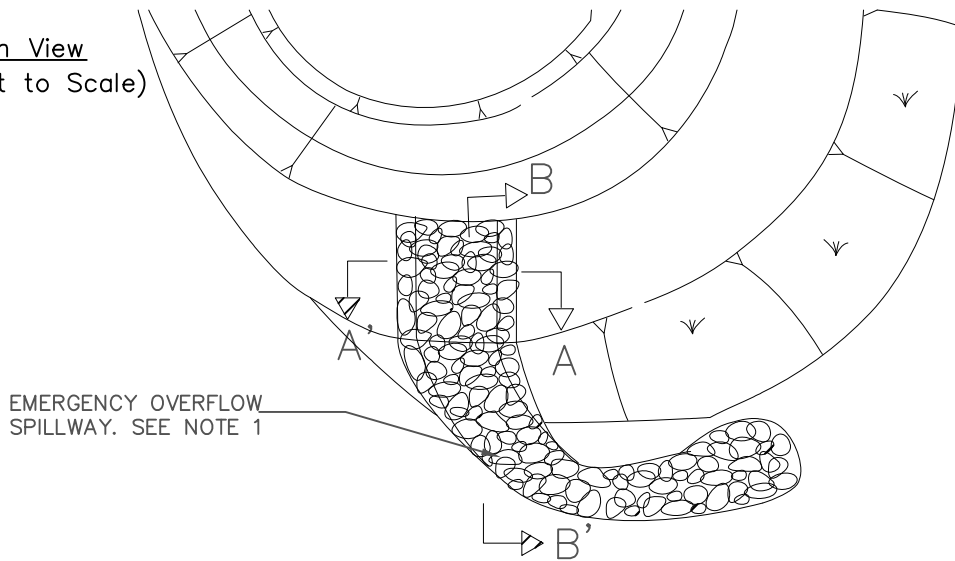
NOTES:

- ① USE A MINIMUM OF A 54" DIA TYPE 2 CATCH BASIN
- ② OUTLET CAPACITY: CAPITAL DEVELOPED PEAK FLOW FOR ON-LINE BASINS.
- ③ METAL PARTS: CORROSION RESISTANT. NON-GALVANIZED PARTS PREFERRED. GALVANIZED PIPE PARTS TO HAVE ASPHALT TREATMENT.
- ④ FRAME AND LADDER OR STEPS OFFSET SO:
 - A. CLEANOUT GATE IS VISIBLE FROM TOP.
 - B. CLIMB-DOWN SPACE IS CLEAR OF RISER AND
 - C. FRAME IS CLEAR OF CURB.
- ⑤ IF METAL OUTLET PIPE CONNECTS TO CEMENT CONCRETE PIPE: OUTLET PIPE TO HAVE SMOOTH O.D. EQUAL TO CONCRETE PIPE I.D. LESS 1/4"
- ⑥ PROVIDE AT LEAST ONE 3 X .090 GAGE SUPPORT BRACKET ANCHORED TO CONCRETE WALL. (MAXIMUM 3' VERTICAL SPACING)
- ⑦ LOCATE ADDITIONAL LADDER RUNGS IN STRUCTURES USED AS ACCESS TO TANKS OR VAULTS TO ALLOW ACCESS WHEN CATCH BASIN IS FILLED WITH WATER

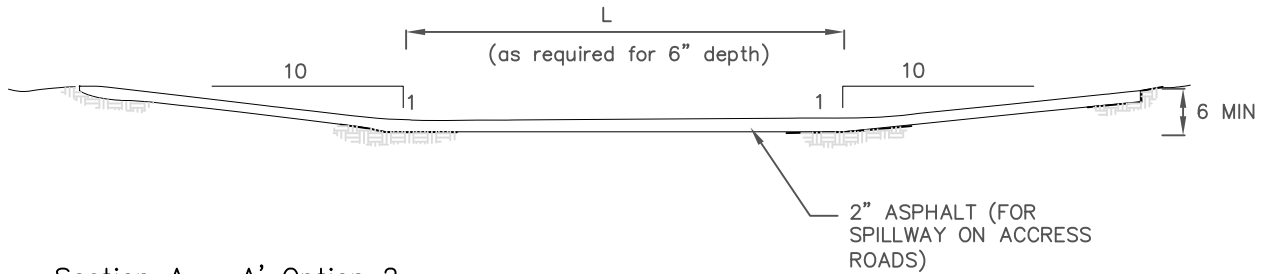


Figure 6-16: Multiple Orifice Outlet

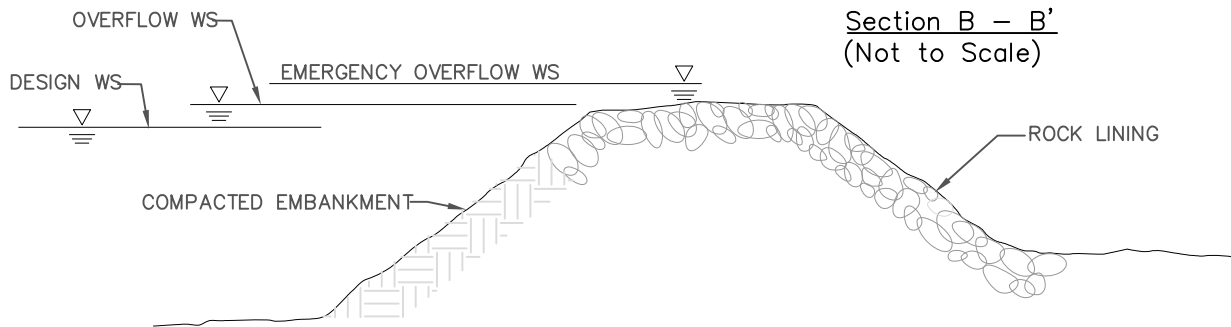
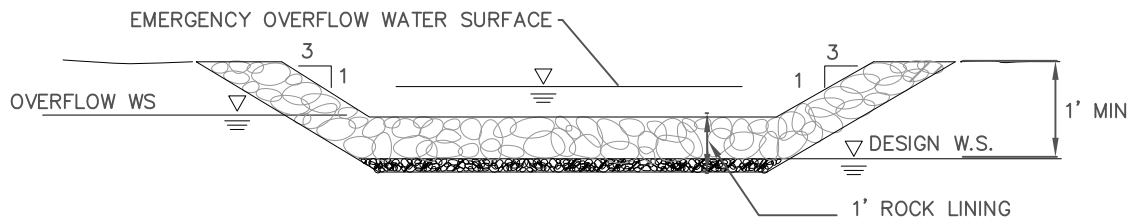
Plan View
(Not to Scale)



Section A – A' Option 1
(Not to Scale)



Section A – A' Option 2
(Not to Scale)



NOTES:

1. ALTERNATIVE SPILLWAY DESIGNS BASED ON THE CALIFORNIA DEPARTMENT OF WATER RESOURCES' GUIDELINES FOR THE DESIGN AND CONSTRUCTION OF SMALL EMBANKMENT DAMS OR AT THE DISCRETION OF THE DEPARTMENT



Figure 6-17: Spillway

Limitations

Limitations for dry extended detention basins include:

- Surface space availability - typically 0.5 to 2.0 percent of the total tributary development area required.
- Depth to groundwater - bottom of basin should be 2 feet higher than the seasonal high water table elevation.
- Steep slopes - basins placed above slopes greater than 15 percent or within 200 feet from the top of a hazardous slope or landslide area require a geotechnical investigation.
- Compatibility with flood control - basins must not interfere with flood control functions of existing conveyance and detention structures.

Design Criteria

The main challenge associated with sand filters is maintaining the filtration capacity, which is critical to the performance of this BMP. If flows entering the sand filter have high sediment concentrations, clogging of the sand filter is likely. Contribution of eroded soils or leaf litter may also reduce the infiltration and associated treatment capacity of the structure. Sand filters should be designed according to the requirements listed in Table 6-19 and outlined in the section below. BMP sizing worksheets are presented in Appendix E.

Table 6-22: Sand Filter Design Criteria

Design Parameter	Unit	Design Criteria
Stormwater quality design volume (SQDV)	acre-feet	See Section 2 and Appendix E for calculating SQDV
Drawdown time for SQDV	hours	Top 50%: 12 hrs (minimum); Bottom 50%: 36 hrs
Basin Design Volume	acre-ft	1.2 * SQDV
Forebay basin size	acre-feet	5 to 15% of SQDV
Maximum forebay drain time	min	45
Low-flow channel depth	inches	9
Low-flow channel flow capacity		2*forebay outlet rate
Freeboard (minimum)	inches	12
Flow path length to width ratio	L:W	2:1, larger preferred; can be achieved using internal berms

Design Parameter	Unit	Design Criteria
Side slope (maximum)	H:V	4:1 (H:V) Interior and 3:1 (H:V) Exterior
Longitudinal slope	percentage	1 (forebay) and 0-2 (main basin)
Low flow channel geometry	feet	depth of 0.5 and width of 1
Maintenance access ramp width	feet	16
Maintenance access ramp slope	H:V	10:1 or flatter
Minimum outflow device diameter	inches	18

Sizing Criteria

Dry extended detention (ED) basins are basins designed such that the SQDV is detained for 48 hours. This allows sediment particles and associated pollutants to settle and be removed from the stormwater. Procedures for sizing extended detention basins are summarized below. A sizing example is also provided.

Step 1: Calculate the design volume

Dry extended detention facilities shall be sized to capture and treat the SQDV (see Section E.1).

Step 2: Calculate the volume of the active basin

The total basin volume shall be increased an additional 20% above the SQDV to account for sediment accumulation, at a minimum. If the basin is designed only for water quality treatment then the basin volume would be 120% of the SQDV. Freeboard is in additional to the total basin volume. Calculate the volume of the active basin (ft³) (V_a):

$$V_a = 1.20 * SQDV \quad \text{(Equation 6-27)}$$

Step 3: Determine detention basin location and preliminary geometry based on site constraints

Based on site constraints, determine the basin geometry (area and length) and the storage available by developing an elevation-storage relationship for the basin. The cross-sectional geometry across the width of the basin shall be approximately trapezoidal with a maximum side slope of 4:1 (H:V) on interior slopes and 3:1 (H:V) on exterior slopes unless specifically permitted by Ventura County (see Side Slopes below). Shallower side slopes are necessary if the basin is designed to have recreational uses during dry weather conditions.

- 1) Calculate the width of the basin footprint (W_{tot}) as follows:

$$W_{tot} = \frac{A_{tot}}{L_{tot}} \quad \text{(Equation 6-28)}$$

Where:

A_{tot} = total surface area of the basin footprint (ft²)

L_{tot} = total length of the basin footprint (ft)

- 2) Calculate the length of the active volume surface area including the internal berm but excluding the freeboard, (L_{av-tot}):

$$L_{av-tot} = L_{tot} - 2Zd_{fb} \quad \text{(Equation 6-29)}$$

Where:

Z = interior side slope as length per unit height (H:V)

d_{fb} = freeboard depth (ft)

- 3) Calculate the width of the active volume surface area including the internal berm but excluding freeboard (ft), (W_{av-tot}):

$$W_{av-tot} = W_{tot} - 2Zd_{fb} \quad \text{(Equation 6-30)}$$

- 4) Calculate the total active volume surface area including the internal berm and excluding freeboard, (A_{av-tot}):

$$A_{av-tot} = L_{av-tot} \times W_{av-tot} \quad \text{(Equation 6-31)}$$

- 5) Calculate the area of the berm, (A_{berm}):

$$A_{berm} = W_{berm} \times L_{berm} \quad \text{(Equation 6-32)}$$

Where:

W_{berm} = width of the internal berm

L_{berm} = length of the internal berm (= width excluding freeboard, W_{av-tot})

- 6) Calculate the surface area excluding the internal berm and freeboard, A_{av} :

$$A_{av} = A_{av-tot} - A_{berm} \quad \text{(Equation 6-33)}$$

Step 4: Determine Dimensions of Forebay

The forebay should be sized to at least 5 to 15% of the basin active volume (V_a). Calculate the active volume of the forebay, (V_f):

$$V_1 = \frac{V_a \times \%V_1}{100} \quad (\text{Equation 6-34})$$

Where:

$\%V_1$ = percent of V_a in forebay (%)

V_a = total active volume (ft³)

7) Calculate the surface area for the active volume of forebay (A_1):

$$A_1 = \frac{V_1}{d_1} \quad (\text{Equation 6-35})$$

Where:

d_1 = average depth for the forebay (ft)

8) Calculate the length of forebay, (L_1):

$$L_1 = \frac{A_1}{W_1} \quad (\text{Equation 6-36})$$

Where:

W_1 = width of forebay (ft)

Step 5: Determine Dimensions of Cell 2

Cell 2 will consist of the remainder of the basin's active volume.

1) Calculate the active volume of Cell 2, (V_2):

$$V_2 = V_a - V_1 \quad (\text{Equation 6-37})$$

Where:

V_a = total basin active volume (ft³)

V_1 = volume of forebay (ft³)

2) Calculate the surface area, A_2 , for the active volume of Cell 2:

$$A_2 = A_{av} - A_1 \quad (\text{Equation 6-38})$$

Where:

A_{av} = basin surface area excluding berm and freeboard (ft²)

A_1 = surface area of forebay (ft²)

- 3) Calculate the average depth (d_2) for the active volume of Cell 2:

$$d_2 = \frac{V_2}{A_2} \quad (\text{Equation 6-39})$$

- 4) Calculate the length of Cell 2, (L_2):

$$L_2 = \frac{A_2}{W_2} \quad (\text{Equation 6-40})$$

Where:

$$W_2 = \text{width of Cell 2 (ft)}$$

- 5) Verify that the length-to-width ratio of Cell 2 at half of d_2 is at least 1.5:1 with $\geq 2:1$ preferred. If the length-to-width ratio is less than 1.5:1, modify input parameters until a ratio of at least 1.5:1 is achieved. If the input parameters cannot be modified as a result of site constraints, another site for the basin should be chosen. Calculate the length-to width (LW_{mid2}) ratio of Cell 2 at half of d_2 follows:

$$LW_{mid2} = \frac{L_{mid2}}{W_{mid2}} \quad (\text{Equation 6-41})$$

Where:

$$W_{mid2} = W_2 - Zd_2 \quad (\text{Equation 6-42})$$

$$L_{mid2} = L_2 - Zd_2 \quad (\text{Equation 6-43})$$

$$W_{mid2} = \text{width of Cell 2 at half of } d_2 \text{ (ft)}$$

$$L_{mid2} = \text{length of Cell 2 at half of } d_2 \text{ (ft)}$$

$$Z = \text{interior side slope as length per unit height (H:V)}$$

$$d_2 = \text{cell 2 average depth (ft)}$$

Step 6: Ensure Design Requirements and Site Constraints are achieved

Check design requirements and site constraints. Modify design geometry until requirements are met. If the chosen site for the basin is inadequate to meet the design requirements, choose a new location or alternative treatment BMP.

Step 7: Size Outlet Structure

The total drawdown time for the basin should be 48 hours. The outlet structure shall be designed to release the bottom 50% of the detention volume (half-full to empty) over 36 hours, and the top half (full to half-full) in 12 hours. A primary overflow should be sized

to pass the peak flow rate from the developed capital design storm. See Section 6 for outlet structure sizing methodologies.

Step 8: Determine Emergency Spillway Requirements

For online basins, an emergency overflow spillway should be sized to pass flows greater than the design peak runoff discharge rate for the 100-yr, 24-hr storm in order to prevent overtopping of the walls or berms in the event that a blockage of the riser occurs. For offline basins, an emergency spillway or riser should be sized to pass the 100-yr, 24-hr post-development peak stormwater runoff discharge rate directly to the downstream conveyance system or another acceptable discharge point. For sites where the emergency spillway discharges to a steep slope, an emergency overflow riser, in addition to the spillway should be provided.

Sizing and Geometry

- 1) The total basin volume shall be increased an additional 20% of the SQDV to account for sediment accumulation, at a minimum. If the basin is designed only for water quality treatment then the basin volume would be 120% of the SQDV. Freeboard is in addition to the total basin volume.
- 2) The minimum freeboard shall be at least 1 foot above the emergency overflow water surface for dry extended detention basins.
- 3) The minimum flow-path length to width ratio at half basin height shall be a minimum of 3:1 (L:W) and can be achieved using internal berms or other means to prevent short-circuiting. Intent: a long flow length will improve fine sediment removal.
- 4) The cross-sectional geometry across the width of the basin shall be approximately trapezoidal with a maximum side slope of 4:1 (H:V) on interior slopes and 3:1 (H:V) on exterior slopes unless specifically permitted by Ventura County (see Side Slopes below). Shallower side slopes are necessary if the basin is designed to have recreational uses during dry weather conditions.
- 5) All dry ED basins shall be free draining and a low flow channel shall be provided. A low flow channel is a narrow, shallow trench filled with pea gravel and encased with filter fabric that runs the length of the basin to drain dry weather flows. The low flow channel shall be of sufficient size considering the natural characteristics of the soil and have a positive-draining gradient flowing toward the outlet structure (typically 1 ft wide by 6 inches deep). If infiltration rates of subsurface soils are insufficient, the low flow channel shall tie into perforated pipe at the outlet structure. If a sand filter or planting media is provided beneath the dry ED basin for increased volume reduction, it may be designed to take the place of the low flow channel.

- 6) The basin bottom shall have a 1% longitudinal slope (direction of flow) in the forebay, and may range from 0 to 2% longitudinal slope in the main basin. The bottom of the basin shall slope 2% toward the center low flow channel.
- 7) A basin shall be large enough to allow for equipment access via a graded 16 foot wide access ramp. If the total basin volume is such that the basin bottom is less than 16 feet wide, an alternative BMP shall be considered or the Ventura County Flood Control District shall be contacted for approval. See Maintenance Access below.

Soils Considerations

- 1) Dry ED basins can be used with almost all soils and geology, with minor design adjustments for rapidly percolating soils (sandy or gravelly soils with infiltration rate > 2.4 in/hr). If rapidly percolating soils are present, dry ED basins shall be lined with compacted low permeability soil or use another other type of liner to prevent rapid, untreated infiltration.
- 2) The slopes of the detention basin shall be analyzed for slope stability using rapid drawdown conditions and shall meet the minimum standards set by the Ventura County Flood Control District. A 1.5 static factor of safety shall be used. Seismic analysis is not required due to the temporary storage of water in the basin.
- 3) The infiltration capability of the dry ED basin can be enhanced by incorporating soil amendments.

Energy Dissipation

- 1) Energy dissipation controls constructed of sound materials such as stones, concrete, or proprietary devices that are rated to withstand the energy of the influent flow shall be installed at the inlet to the sediment forebay. Flow velocity into the basin forebay shall be controlled to 4 feet per second (ft/sec) or less.
- 2) Energy dissipation controls must also be used at the outlet/spillway from the detention basin unless the basin discharges to a storm drain or hardened channel.

Sediment Forebay

As untreated stormwater enters the dry ED basin, it passes through a sediment forebay for coarse solids removal. The forebay may be constructed using an internal berm constructed out of earthen embankment material, grouted riprap, stop logs, or other structurally sound material.

- 1) The basin shall be sized so that 5 to 15% of the total basin volume is in the forebay and 85 to 95% of the total basin volume is in the main portion of the basin.
- 2) A gravity drain outlet from the forebay (2 inch minimum diameter) must extend the entire width of the internal berm and be designed to completely drain to the main basin within 10 minutes.

- 3) The forebay outlet shall be offset (horizontally) from the inflow streamline to prevent short-circuiting.
- 4) Permanent steel post depth markers shall be placed in the forebay to define sediment removal limits at 50% of the forebay sediment storage depth.

Vegetation

Vegetation within the dry ED basin provides erosion protection from wind and water and biofiltration of stormwater. The City shall review and approve any proposed basin landscape plan prior to implementation and following guidelines shall be followed:

- 1) The bottom and slopes of the dry ED basin shall be vegetated. A mix of erosion-resistant plant species that effectively bind the soil shall be used on the slopes and a diverse selection of plants that thrive under the specific site, climatic, and watering conditions shall be specified for the basin bottom. The basin bottom shall not be planted with trees, shrubs, or other large woody plants that may interfere with sediment removal activities. The basin shall be free of floating objects. Only native perennial grasses, forbs, or similar vegetation that can be replaced via seeding shall be used on the basin bottom.
 - a. Landscaping outside of the basin is required for all dry ED basins and must adhere to the following criteria so as not to hinder maintenance operations:
 - b. No trees or shrubs may be planted within 15 feet of inlet or outlet pipes or manmade drainage structures such as spillways, flow spreaders, or earthen embankments. Species with roots that seek water, such as willow or poplar, shall not be used within 50 feet of pipes or manmade structures. Weeping willow (*Salix babylonica*) shall not be planted in or near detention basins.
- 2) Prohibited non-native plant species will not be permitted. For more information on invasive weeds, including biology and control of listed weeds, look at the encyclopedias located at the California Department of Food and Agriculture website or the California Invasive Plant Council website at www.cal-ipc.org.
- 3) A plant list provided by a landscape professional should be used as a guide only and shall not replace project-specific planting recommendations, including recommendations on appropriate plants, fertilizer, mulching applications, and irrigation requirements (if any) to ensure healthy vegetation growth.

Sand Filter or Planting Media Layer

For increasing the volume reduction capability of a dry ED basin, an appropriately sized sand filter or planting media layer can be placed beneath the dry ED basin to achieve desired volume reduction goals if soil and slope conditions allow (i.e., infiltration rate greater than 0.5 in/hr but less than 2.4 in/hr; site slope less than 15%). The drawdown time of the sand filter or planting media layer shall be less than 72 hours. The base of the sand filter or planting media layer shall be level (i.e., zero slope). If a sand filter/planting

media layer is provided over the length of the basin, it can take the place of the low-flow channel so long as it is designed to adequately infiltrate dry weather flows. Sizing of the sand filter and planting media layer for dry ED basins is the same as for [sand filters](#) and [bioretention](#) areas, respectively. The depth of water in the dry ED basin shall not exceed 6 feet.

Outlet Structure and Drawdown Time

A drawdown time of 36 to 48 hours shall be provided for the SQDV. This drawdown time is for the volume in the basin above the sand filter layer (if provided) and serves the purpose of water quality treatment. An outflow device shall be designed to release the bottom 50% of the detention volume (half-full to empty) over 24 to 32 hours, and the top half (full to half-full) in 12 to 16 hours. *The intention is that the drawdown schemes that detain low flows for longer periods than high flows have the following advantages over outlets that drain the basin evenly:*

- Greater flood control capabilities
- Enhanced treatment of low flows which make up the bulk of incoming flows.

Additional storage, detention, and outlet control is required to achieve pre-development stormwater runoff discharge rates for hydromodification control. The outlet structure can be designed to achieve flow control for meeting the multiple objectives of water quality and flow attenuation.

The outflow device (i.e., outlet pipe) shall be oversized (18 inch minimum diameter). There are two options that can be used for the outlet structure:

- 1) Uniformly perforated riser structures.
- 2) Multiple orifice structures (orifice plate).

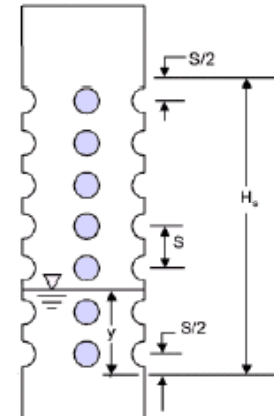
The outlet structure can be placed in the basin with a debris screen (Figure 6-15) or housed in a standard manhole (Figure 6-16). If a multiple orifice structure is used, an orifice restriction (if necessary) shall be used to limit orifice outflow to the maximum discharge rates allowable for achieving the desired water quality and flow control objectives. Orifice restriction plates shall be removable for emergency situations. A removable trash rack shall be provided at the outlet. Orifice plates and trash racks shall be galvanized. Mounting hardware shall use stainless steel bolts.

Note that a primary overflow (typically a riser pipe connected to the outlet works) shall be sized to pass flows larger than the stormwater quality design storm (if the ED basin is sized only for water quality) or to pass flows larger than the peak flow rate of the maximum design storm to be detained in the basin (e.g., 100-yr, 24-hr). The primary overflow is intended to protect against overtopping or breaching of a basin embankment.

Perforated Risers Outlet Sizing Methodology

The following attributes influence the perforated riser outlet sizing calculations:

- Shape of the basin (e.g., trapezoidal)
- Depth and volume of the basin
- Elevation / depth of first row of holes
- Elevation / depth of last row of holes
- Size of perforations
- Number of rows or perforations and number of perforations per row
- Desired drawdown time (e.g., 16 hour and 32 hour draw down for top half and bottom half respectively, 48 hour total drawdown time for the stormwater quality design volume)



Perforated Riser Outlet
Geosyntec Consultants

The governing rate of discharge from a perforated riser structure can be calculated using Equation 6-44 below:

$$Q = C_p \frac{2A_p}{3H_s} \sqrt{2gH}^{3/2} \quad (\text{Equation 6-44})$$

Where:

- Q = riser flow discharge (cfs)
- C_p = discharge coefficient for perforations (use 0.61)
- A_p = cross-sectional area of all the holes (ft²)
- s = center to center vertical spacing between perforations (ft)
- H_s = distance from $s/2$ below the lowest row of holes to $s/2$ above the top row of holes (McEnroe 1988).
- H = effective head on the orifice (measured from center of orifice to water surface)

For the iterative computations needed to size the perforations in the riser and determine the riser height, a simplified version of Equation 6-44 may be used as shown below in Equation 6-45 and Equation 6-46:

$$Q = kH^{3/2} \quad \text{(Equation 6-45)}$$

Where:

H = effective head on the orifice (measured from center of orifice to water surface)

$$k = C_p \frac{2A_p}{3H_s} \sqrt{2g} \quad \text{(Equation 6-46)}$$

Where:

C_p = discharge coefficient for perforations (use 0.61)

A_p = cross-sectional area of all the holes (ft²)

s = center to center vertical spacing between perforations (ft)

H_s = distance from s/2 below the lowest row of holes to s/2 above the top row of holes.

g = 32.17 ft/sec²

Uniformly perforated riser designs are defined by the depth or elevation of the first row of perforations, the length of the perforated section of pipe, and the size or diameter of each perforation.

Multiple Orifice Outlet Sizing Methodology

The following attributes influence multiple orifice outlet sizing calculations:

- Shape of the basin (e.g., trapezoidal)
- Depth and volume of the basin
- Elevation of each orifice
- Desired draw-down time (e.g., 16 hour and 32 hour draw down times for top half and bottom half respectively, 48 hour drawdown time for stormwater quality design volume)

The rate of discharge from a single orifice can be calculated using Equation 6-22.

$$Q = CA(2gH)^{0.5} \quad \text{(Equation 6-47)}$$

Where:

Q = orifice flow discharge

C	=	discharge coefficient
A	=	cross-sectional area of orifice or pipe (ft ²)
g	=	acceleration due to gravity (32.2 ft/s ²)
H	=	effective head on the orifice (measured from center of orifice to water surface)

Multiple orifice designs are defined by the depth (or elevation) and the size (or diameter) of each orifice. The steps needed to size a dual orifice outlet are outlined in Appendix E; multiple orifices may be provided and sized using a similar approach.

Emergency Spillway

An emergency overflow spillway in addition to the primary overflow outlet (as described above) is required. The emergency spillway shall be sized for flows greater than the peak 100-year 24-hour storm if the basin is designed on-line or, if the basin is designed on-line, the spillway shall be sized for flows greater than the basin design volume (e.g., stormwater quality design volume). The spillway shall be constructed with reinforced concrete and provide for adequate energy dissipation downstream. The spillway shall allow for at least 12 inches of freeboard above the emergency overflow water surface elevation if the basin is on-line. If the basin is on-line, 2 feet of freeboard is preferable.

Spillways shall meet the California Department of Water Resources, Division of Safety of Dams Guidelines for the Design and Construction of Small Embankment Dams (<http://damsafety.water.ca.gov/docs/GuidelinesSmallDams.pdf>). *Intent: Emergency overflow spillways are intended to control the location of basin overtopping and safely direct overflows back into the downstream conveyance system or other acceptable discharge point.*

On-line Basins

- 1) On-line basins must have an emergency overflow spillway to prevent overtopping of walls or berms should blockage of the primary outlet occur based on a downstream risk assessment.
- 2) The overflow spillway must be sized to pass flows greater than the design peak runoff discharge rate for the 100-yr, 24-hr storm.
- 3) The minimum freeboard shall be 1 foot (but preferably at least 2 feet) above the maximum water surface elevation over the emergency spillway.

Off-line Basins

- 1) Off-line basins must have either an emergency overflow spillway or an emergency overflow riser. The emergency overflow must be designed to pass the 100-yr 24-hr post-development peak stormwater runoff discharge rate directly to the downstream

conveyance system or another acceptable discharge point. Where an emergency overflow spillway would discharge to a steep slope, an emergency overflow riser, in addition to the spillway shall be provided.

- 2) The emergency overflow spillway shall be armored to withstand the energy of the spillway flows. The spillway shall be constructed of grouted rip-rap.
- 3) The minimum freeboard shall be 1 foot above the maximum water surface elevation over the emergency spillway.

Side Slopes

- 1) Interior side slopes above the stormwater quality design depth and up to the emergency overflow water surface shall be no steeper than 4:1 (H:V), unless stabilization has been approved by a licensed civil engineer and the City.
- 2) Exterior side slopes shall be no steeper than 2:1 (H:V), unless stabilization has been approved by a licensed civil engineer and the City.
- 3) For any slope (interior or exterior) greater than 2:1 (H:V), a geotechnical investigation and report must be submitted and approved by the City.
- 4) Landscaped slopes must be no greater than 3:1 (H:V) to allow for maintenance.
- 5) Basin walls may be vertical retaining walls, provided: (a) they are constructed of reinforced concrete, (b) a fence is provided along the top of the wall (see fencing below) or further back, and (c) the design is stamped by a licensed civil engineer and approved by the City.

Embankments

- 1) Earthworks and berm embankments shall be performed in accordance with the latest edition of the “Greenbook Standard Specifications for Public Works Construction”.
- 2) Embankments are earthen slopes or berms used for detaining or redirecting the flow of water.
- 3) Top of berm separating forebay and main basin shall be 2 feet minimum below the stormwater quality design water surface and shall be keyed into embankment a minimum of 1 foot on both sides.
- 4) Typically, the top width of berm embankments are at least 20 feet, but narrower embankments may be plausible if approved by the civil engineer and the City.
- 5) Basin berm embankments must be constructed on native consolidated soil (or adequately compacted and stable fill soils analyzed by a licensed civil engineer) free of loose surface soil materials, roots, and other organic debris.

- 6) The berm embankment shall be constructed of compacted soil (95% minimum dry density, modified proctor method per ASTM D1557), placed in 6-inch lifts.
- 7) Basin berm embankments greater than 4 feet in height must be constructed by excavating a key equal to 50% of the berm embankment cross-sectional height and width. This requirement may be waived if specifically recommended by a licensed civil engineer.
- 8) The berm embankment shall be constructed of compacted soil (95% minimum dry density, modified proctor method per ASTM D1557), placed in 6-inch lifts.
- 9) Low growing native or non-invasive perennial grasses shall be planted on downstream embankment slopes. See vegetation section below.

Fencing



- 1) Safety is provided either by fencing of the facility or by managing the contours of the basin to eliminate drop-offs and other hazards.
- 2) If fences are required, fences shall be designed and constructed in accordance with relevant standards and must typically be located at or above the overflow water surface elevation. Shrubs (approved, California-adapted species) can be used to hide the fencing. See vegetation section above.

Right-of-Way

- 1) Dry extended detention basins and associated access roads to be maintained by the City shall be dedicated in fee or in an easement to the City with appropriate access.

Maintenance Access

- 1) Ownership of the basin and maintenance thereof is the responsibility of the developer/applicant. A maintenance agreement with the City is required to ensure adequate performance and allow the City emergency access to the facilities.
- 2) Maintenance access road(s) shall be provided to the control structure and other drainage structures associated with the basin (e.g., inlet, emergency overflow or bypass structures). Manhole and catch basin lids must be in or at the edge of the access road.
- 3) A graded 16-foot wide access ramp into the basin shall be constructed near the basin outlet. An access ramp is required for removal of sediment with a backhoe or loader and truck. The ramp must extend to the basin bottom to avoid damage to vegetation planted on the basin slope. A 16-foot wide commercial driveway approach shall be provided where curb and gutter front the maintenance ramp.
- 4) All access ramps and roads shall be provided in accordance with the current policies of the Ventura County Flood Control District or local approval authority.

Construction Considerations

The use of treated wood or galvanized metal anywhere inside the facility is prohibited.

Operations and Maintenance

Maintenance is of primary importance if extended detention basins are to continue to function as originally designed. A maintenance agreement must be developed with the local approval authority to ensure adequate performance and allow emergency access. Maintenance of the basin is the responsibility of the development, unless otherwise agreed upon.

A specific maintenance plan shall be formulated for each facility outlining the schedule and scope of maintenance operations, as well as the data handling and reporting requirements. The following are general maintenance requirements:

- 1) The basin shall be inspected semiannually or more frequently, and inspections after major storm events are encouraged (see Appendix I for guidance on facility maintenance inspections). Trash and debris shall be removed as needed, but at least annually prior to the beginning of the wet season (see Appendix I for dry extended detention basin inspection and maintenance checklist).
- 2) Site vegetation shall be maintained as follows:
 - Vegetation, large shrubs, or trees that limit access or interfere with basin operation shall be pruned or removed.
 - Slope areas that have become bare shall be revegetated and eroded areas shall be regraded prior to being revegetated.
 - Grass shall be mowed to 4 to 9 inch high and grass clippings shall be removed.
 - Fallen leaves and debris from deciduous plant foliage shall be raked and removed.
 - Invasive vegetation, such as Alligatorweed (*Alternanthera philoxeroides*), Halogeton (*Halogeton glomeratus*), Spotted Knapweed (*Centaurea maculosa*), Giant Reed (*Arundo donax*), Castor Bean (*Ricinus communis*), Perennial Pepperweed (*Lepidium latifolium*), and Yellow Starthistle (*Centaurea solstitialis*) must be removed and replaced with non-invasive species. Invasive species shall never contribute more than 25% of the vegetated area. For more information on invasive weeds, including biology and control of listed weeds, look at the encyclopedias located at the California Department of Food and Agriculture website- http://www.cdfa.ca.gov/phpps/ipc/encycloweedia/encycloweedia_hp.htm or the California Invasive Plant Council website at www.cal-ipc.org.

- Dead vegetation shall be removed if it exceeds 10% of area coverage. Vegetation shall be replaced immediately to maintain cover density and control erosion where soils are exposed.
 - No herbicides or other chemicals shall be used to control vegetation.
- 3) Sediment buildup exceeding 50% of the forebay capacity shall be removed. Sediment from the remainder of the basin shall be removed when 6 inches of sediment accumulates. Sediments shall be tested for toxic substance accumulation in compliance with current disposal requirements if land uses in the catchment include commercial or industrial zones, or if visual or olfactory indications of pollution are noticed. If toxic substances are encountered at concentrations exceeding thresholds of Title 22, Section 66261 of the California Code of Regulations, the sediment must be disposed of in a hazardous waste landfill. It is recommended to clean the forebay frequently to reduce frequency of main basin cleaning.
 - 4) Remove sediment from basin when accumulation reaches 25% of original design depth. Cleaning is recommended to occur in early spring to allow vegetation to reestablish.
 - 5) Repair erosion to banks and bottom of basin as required.
 - 6) Following sediment removal activities, replanting, and/or reseeding of vegetation may be required for reestablishment.
 - 7) Control vectors as needed.

TCM-2: Wet Detention Basin

Wet detention basins are constructed, naturalistic ponds with a permanent or seasonal pool of water (also called a “wet pool” or “dead storage”). Aquascape facilities, such as artificial lakes, are a special form of wet pool facility that can incorporate innovative design elements to allow them to function as a stormwater treatment facility in addition to an aesthetic water feature. Wetponds require base flows to exceed or match losses through evaporation and/or infiltration and they must be designed with the outlet positioned and/or operated in such a way as to maintain a permanent pool. Wetponds can be designed to provide extended detention of incoming flows using the volume above the permanent pool surface.



Wet Detention Basin

Photo Credit: Geosyntec Consultants

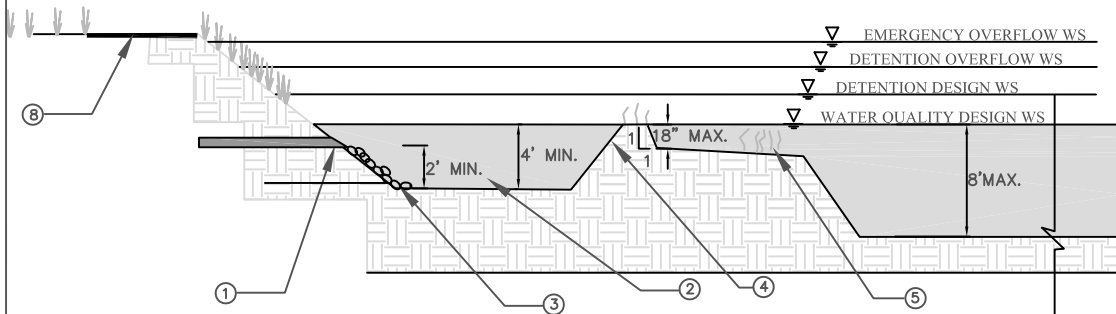
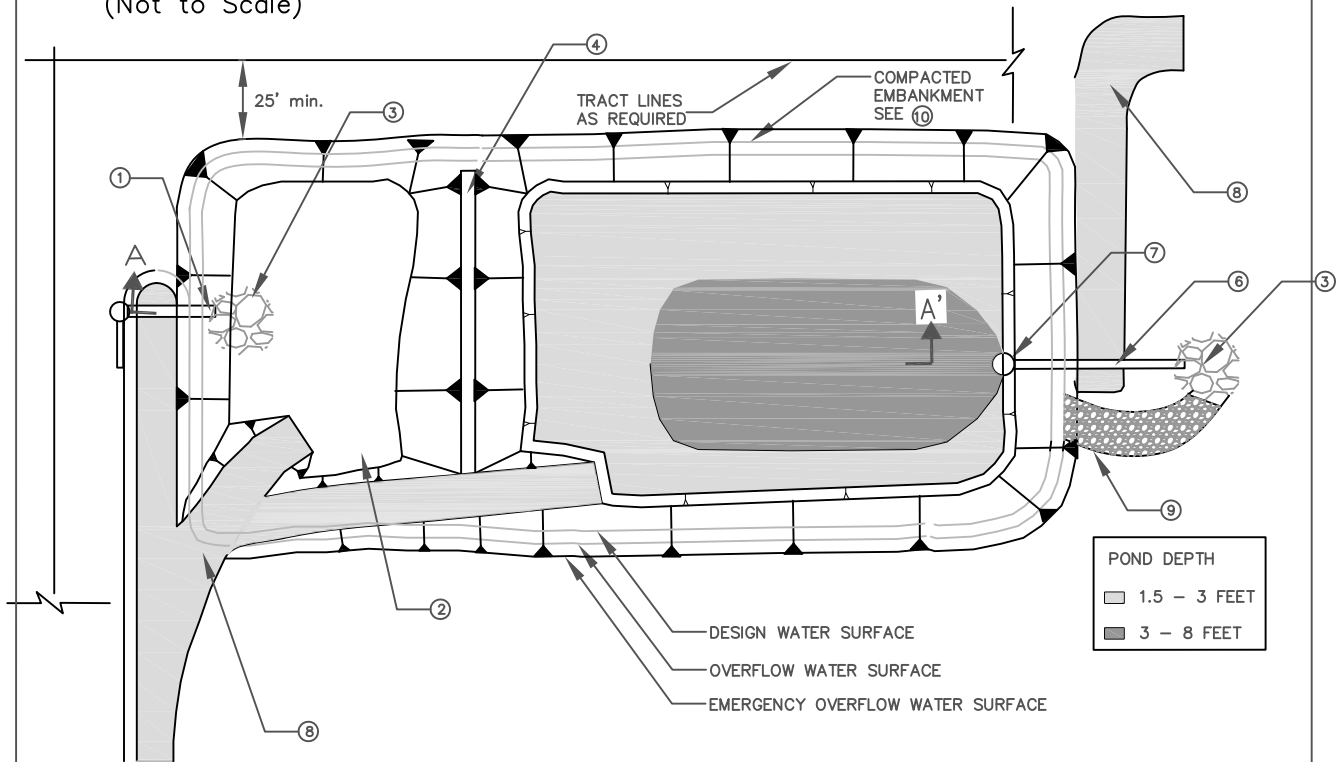
Application

- Regional detention & treatment
- Roads, highways, parking lots, commercial, residential
- Parks, open spaces, and golf courses

Preventative Maintenance

- inspected at a minimum annually and inspections after major storm events
- Pruned or remove vegetation, large shrubs, or trees that limit access or interfere with basin operation
- Remove sediment buildup at inlets and outlets

Plan View
(Not to Scale)



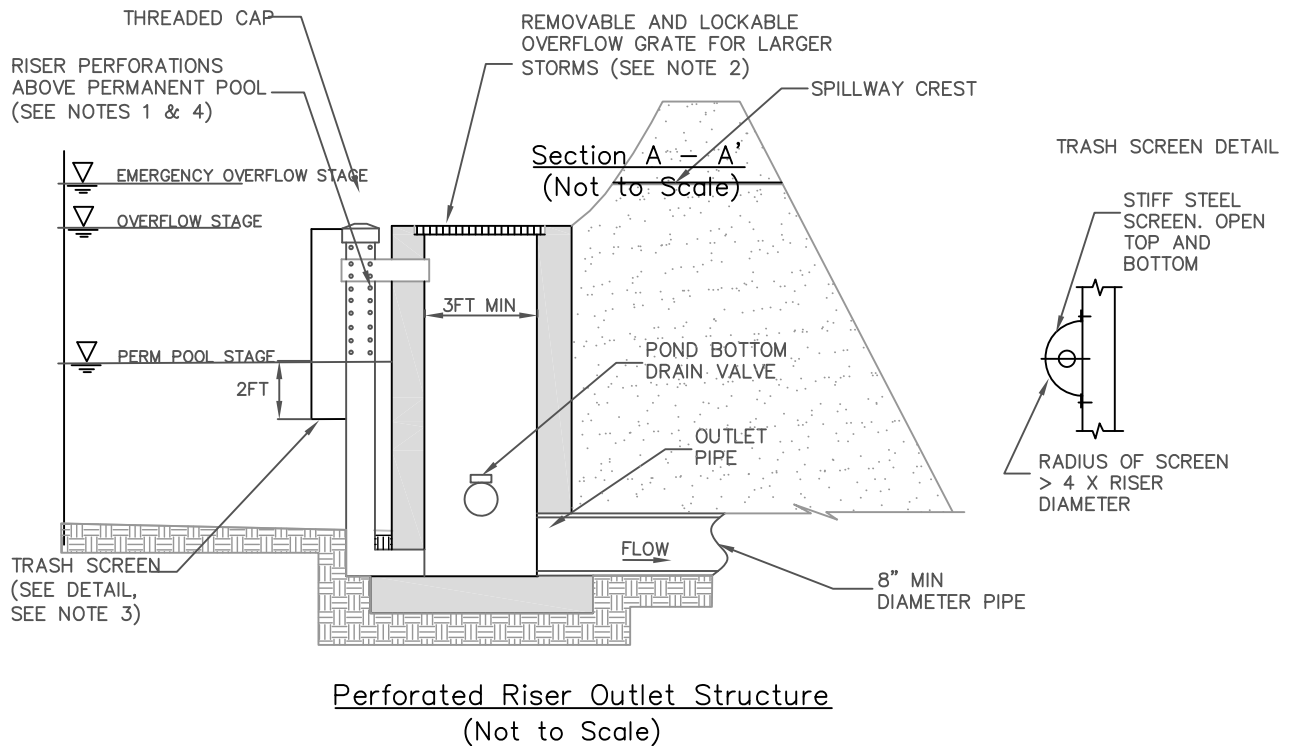
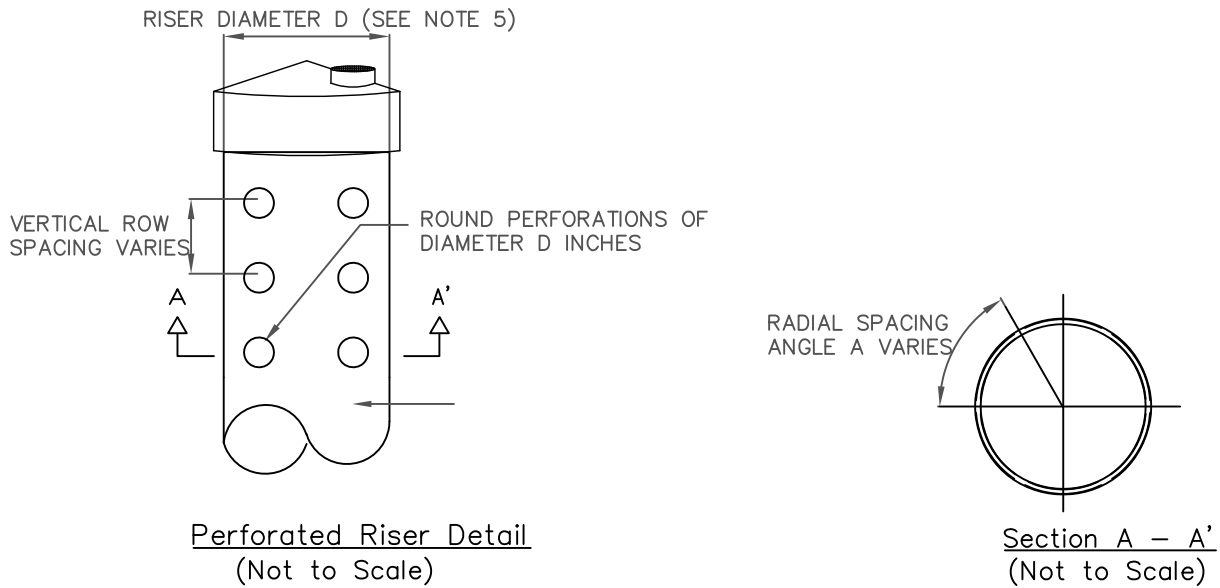
Section A - A'
(Not to Scale)

NOTES:

- ① INLET PIPE SHOULD BE SUBMERGED WITH A MINIMUM OF 2' DISTANCE FROM THE BOTTOM
- ② FIRST CELL VOLUME SHALL EQUAL 25% TO 35% OF TOTAL WETPOND VOLUME. DEPTH SHALL BE 4' MIN TO 8' MAX PLUS AN ADDITIONAL 1' MIN SEDIMENT STORAGE DEPTH.
- ③ RIP RAP APRON OR OTHER ENERGY DISSIPATION.
- ④ BERM SHALL EXTEND ACROSS ENTIRE WIDTH OF THE WETPOND.
- ⑤ EMERGENT VEGETATION SHALL BE PLANTED IN REGIONS OF THE POND THAT ARE 3' DEEP OR LESS.
- ⑥ SIZE OUTLET PIPE TO PASS CAPITAL DESIGN PEAK FLOW FOR ON-LINE PONDS AND WATER QUALITY PEAK FLOW FOR OFF-LINE PONDS.
- ⑦ WATER QUALITY OUTLET STRUCTURE. SEE FIGURE 8-2 AND FIGURE 8-3 FOR DETAILS.
- ⑧ INSTALL PAVED MAINTENANCE ACCESS ROAD. SLOPE SHOULD NOT EXCEED 12%. SHOULD PROVIDE ACCESS TO BOTH THE FIRST CELL AND MAIN BASIN.
- ⑨ INSTALL EMERGENCY OVERFLOW SPILLWAY AS NEEDED. SEE FIGURE 2-4 FOR DETAILS
- ⑩ EMBANKMENT SIDE SLOPES SHALL BE NO STEEPER THAN 2H:1V OUTSIDE AND 3H:1V INSIDE

Geosyntec
consultants

Figure 6-18: Wet Detention Basin

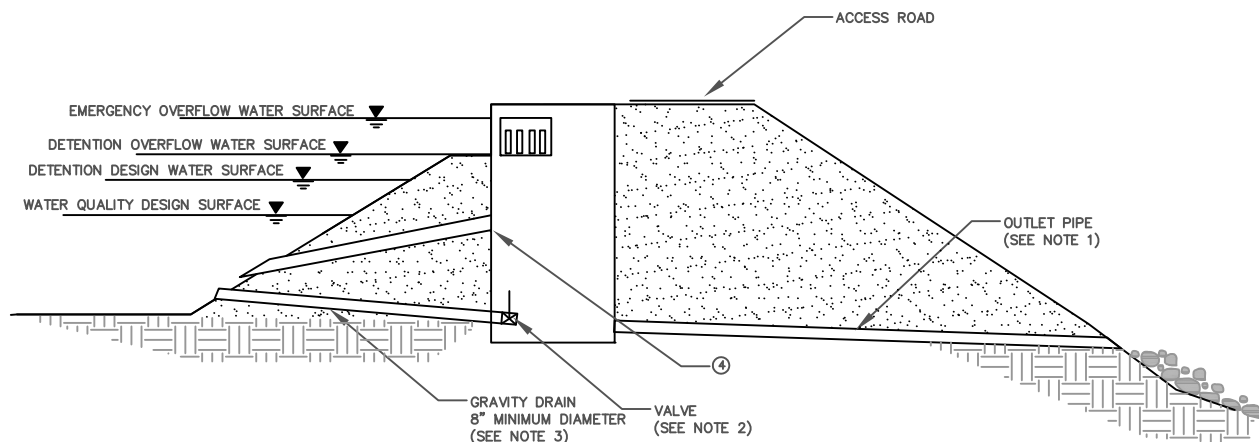


NOTES:

- ① RISER PIPE SHALL BE SIZED TO PROVIDE 36 TO 48-HOUR FULL BRIM DRAW DOWN TIME.
- ② TOTAL OUTLET CAPACITY: CAPITAL DEVELOPED PEAK FLOW FOR ON-LINE BASINS AND WATER QUALITY DESIGN FLOW FOR OFF-LINE BASINS.
- ③ SCREEN OPENINGS SHALL BE AT LEAST 1/4" AND SHALL NOT EXCEED THE DIAMETER OF THE PERFORATIONS ON THE RISER.
- ④ RISER PIPE PERFORATION DIAMETER SHALL BE NO LESS THAN 1/2" AND NO MORE THAN 2"
- ⑤ MINIMUM PIPE DIAMETER (D) IS 2'
- ⑥ RISER PIPE MATERIAL IS CMP



Figure 6-19: Riser Outlet



Inverted Pipe Outlet Structure
(Not to Scale)

NOTES:

- ① SIZE OUTLET PIPE SYSTEM TO PASS CAPITAL PEAK FLOW FOR ON-LINE PONDS AND WATER QUALITY PEAK FLOW FOR OFF-LINE PONDS.
- ② VALVE MAY BE LOCATED INSIDE MANHOLE OR OUTSIDE WITH APPROVED OPERATIONAL ACCESS
- ③ INVERT OF DRAIN SHALL BE 6" MINIMUM BELOW TOP OF INTERNAL BERM. LOWER PLACEMENT IS DESIRABLE. INVERT SHALL BE 6" MINIMUM ABOVE BOTTOM OF POND.
- ④ OUTLET PIPE INVERT SHALL BE AT WETPOOL WATER SURFACE ELEVATION

Geosyntec
consultants

Figure 6-20: Inverted Pipe Outlet

Limitations

Limitations for wet detention basins include:

- Wet detention basins typically are used for treating areas larger than 10 acres and less than 10 square miles. They are especially applicable for regional water quality treatment and flow control.
- Off-line wet detention basins must not interfere with flood control functions of existing conveyance and detention structures.
- If wet detention basins are located in areas with site slopes greater than 15% or within 200 feet of a hazardous steep slope or mapped landslide area (on the uphill side), a geotechnical investigation and report must be provided to ensure that the basin does not compromise the stability of the site slope or surrounding slopes.
- Wet detention basins require a regular source of base flow if water levels are to be maintained. If base flow is insufficient during summer months, supplemental water may be necessary to maintain water levels.

Design Criteria

The main challenge associated with wet detention basins is maintaining desired water levels. A wet detention basin should be designed according to the requirements listed in Table 6-23 and outlined in the section below. BMP sizing worksheets are presented in Appendix E.

Table 6-23: Wet Detention Basin Design Criteria

Design Parameter	Unit	Design Criteria
Stormwater quality design volume, SQDV	acre-ft	See Section 2 and Appendix E for calculating SQDV.
Permanent Pool Volume		SQDV
Forebay Volume		5 to 10% of SQDV
Maximum Forebay Drain Time	min	45
Depth without sediment storage	feet	0.5-12 (littoral zone, 25-40% permanent pool) 4 (first cell minimum) 8 (any cell maximum) Deeper zone: 4-8 feet average; 12 feet maximum depth
Maximum residence time	Days	7 (dry weather)
Freeboard (minimum)	inches	12

Flow path length to width ratio	L:W	2:1 (larger preferred)
Side slope (maximum)	H:V	4:1 (H:V) Interior and 3:1 (H:V) Exterior
Longitudinal slope	percentage	1 (forebay) and 0-2 (main basin)
Vegetation Type	--	Varies see vegetation section below
Vegetation Height	--	Varies see vegetation section below
Buffer zone (minimum)	feet	25
Maintenance access ramp width	feet	16
Maintenance access ramp slope	H:V	10:1 or flatter
Minimum outflow device diameter	inches	18

Sizing Criteria

Wet Detention basins may be designed with or without extended detention above the permanent pool. The extended detention portion of the wet detention basin above the permanent pool, if provided, functions like a dry extended detention (ED) basin (see [VEG-5: Dry Extended Detention Basin](#)). If there is no extended detention provided, wet detention basins shall be sized to provide a minimum wet pool volume equal to the stormwater quality design volume plus an additional 5% for sediment accumulation. If extended detention is provided above the permanent pool, the sizing is dependent of the functionality of the basin; the basin may function as water quality treatment only or water quality plus peak flow attenuation.

If and the basin is designed for water quality treatment only, then the permanent pool volume shall be a minimum of 10 percent of the stormwater quality design volume and the surcharge volume (above the permanent pool) shall make up the remaining 90 percent. If extended detention is provided above the permanent pool and the basin is designed for water quality treatment and peak flow attenuation, then the permanent pool volume shall be equal to the water quality treatment volume, and the surcharge volume shall be sized to attenuate peak flows in order to meet the peak runoff discharge requirements. The extended detention portion of the wet detention basin above the permanent pool, if provided, functions like a dry extended detention (ED) basin (see [VEG-5: Dry Extended Detention Basin](#)).

Step 1: Calculate the design volume

Wet detention basins shall be sized with a permanent pool volume equal to the SQDV volume (see [Section 2](#) and Appendix E).

Step 2: Determine the active design volume for the wet detention basin without extended detention

The active volume of the wet detention basin, V_a , shall be equal to the SQFV plus an additional 5% for sediment accumulation.

$$V_a = 1.05 \times SQDV \quad (\text{Equation 6-48})$$

Step 3: Determine pond location and preliminary geometry based on site constraints

Based on site constraints, determine the pond geometry and the storage available by developing an elevation-storage relationship for the pond. Note that a more natural geometry may be used and is in many cases recommended; the preliminary basin geometry calculations should be used for sizing purposes only.

1) Calculate the width of the pond footprint, W_{tot} , as follows:

$$W_{tot} = \frac{A_{tot}}{L_{tot}} \quad (\text{Equation 6-49})$$

Where:

A_{tot} = total surface area of the pond footprint (ft²)

L_{tot} = total length of the pond footprint (ft)

1) Calculate the length of the active volume surface area including the internal berm but excluding the freeboard, L_{av-tot} :

$$L_{av-tot} = L_{tot} - 2Zd_{fb} \quad (\text{Equation 6-50})$$

Where:

Z = interior side slope as length per unit height

d_{fb} = freeboard depth

2) Calculate the width of the active volume surface area including the internal berm but excluding freeboard, W_{av-tot} :

$$W_{av-tot} = W_{tot} - 2Zd_{fb} \quad (\text{Equation 6-51})$$

3) Calculate the total active volume surface area including the internal berm and excluding freeboard, A_{av-tot} :

$$A_{av-tot} = L_{av-tot} \times W_{av-tot} \quad (\text{Equation 6-52})$$

4) Calculate the area of the berm, A_{berm} :

$$A_{berm} = W_{berm} \times L_{berm} \quad (\text{Equation 6-53})$$

Where:

W_{berm} = width of the internal berm

L_{berm} = length of the internal berm

- 5) Calculate the active volume surface area excluding the internal berm and freeboard, A_{wq} :

$$A_{wq} = A_{wq = tot} - A_{berm} \quad (\text{Equation 6-54})$$

Step 4: Determine Dimensions of Forebay

The wet detention basin shall be divided into two cells separated by a berm or baffle. The forebay shall contain between 5 and 10 percent of the total volume. The berm or baffle volume shall not count as part of the total volume. Calculate the active volume of forebay, V_1 :

$$V_1 = \frac{V_a \times \%V_1}{100} \quad (\text{Equation 6-55})$$

Where:

$\%V_1$ = percent of SQDV in forebay (%)

- 1) Calculate the surface area for the active volume of forebay, A_1 :

$$A_1 = \frac{V_1}{d_1} \quad (\text{Equation 6-56})$$

Where:

d_1 = average depth for the active volume of forebay (ft)

- 1) Calculate the length of forebay, L_1 . Note, inlet and outlet should be configured to maximize the residence time.

$$L_1 = \frac{A_1}{W_1} \quad (\text{Equation 6-57})$$

Where:

W_1 = width of forebay (ft), $W_1 = W_{av-tot} = L_{berm}$

Step 5: Determine Dimensions of Cell 2

Cell 2 will consist of the remainder of the basin's active volume.

- 1) Calculate the active volume of Cell 2, V_2 :

$$V_2 = V_a - V_1 \quad (\text{Equation 6-58})$$

- 2) The minimum wetpool surface area includes 0.3 acres of wetpool per acre-foot of permanent wetpool volume. Calculate A_{min2} :

$$A_{min2} = (V_2 \times 0.3 \frac{\text{acres}}{\text{acre-foot}}) \quad (\text{Equation 6-59})$$

- 3) Calculate the actual wetpool surface area, A_2 :

$$A_2 = A_{av} - A_1 \quad (\text{Equation 6-60})$$

Verify that A_2 is greater than A_{min2} . If A_2 is less than A_{min2} , then modify input parameters to increase A_2 until it is greater than A_{min2} . If site constraints limit this criterion, then another site for the pond should be chosen.

- 4) Calculate the top length of Cell 2, L_2 :

$$L_2 = \frac{A_2}{W_2} \quad (\text{Equation 6-61})$$

Where:

$$W_2 = \text{width of Cell 2 (ft), } W_2 = W_1 = W_{wq-tot} = L_{berm}$$

- 5) Verify that the length-to-width ratio of Cell 2 is at least 1.5:1 with $\geq 2:1$ preferred. If the length-to-width ratio is less than 1.5:1, modify input parameters until a ratio of at least 1.5:1 is achieved. If the input parameters cannot be modified as a result of site constraints, another site for the pond should be chosen.

$$LW_2 = \frac{L_2}{W_2} \quad (\text{Equation 6-62})$$

- 6) Calculate the emergent vegetation surface area, A_{ev} :

$$A_{ev} = \frac{A_2 \bullet \% A_{ev}}{100} \quad (\text{Equation 6-63})$$

Where:

$$\%A_{ev} = \text{percent of surface area that will be planted with emergent vegetation}$$

- 7) Calculate the volume of the emergent vegetation shallow zone (1.5 – 3 ft), V_{ev} :

$$V_{ev} = A_{ev} \bullet d_{ev} \quad (\text{Equation 6-64})$$

Where:

d_{ev} = average depth of the emergent vegetation shallow zone (1.5 – 3 ft)

8) Calculate the length of the emergent vegetation shallow zone, L_{ev} :

$$L_{ev} = \frac{A_{ev}}{W_{ev}} \quad (\text{Equation 6-65})$$

Where:

W_{ev} = width of the emergent vegetation shallow zone (ft), $W_{ev} = W_2$

9) Calculate the volume of the deep zone, V_{deep} :

$$V_{deep} = V_2 - V_{ev} \quad (\text{Equation 6-66})$$

10) Calculate the surface area of the deep (>3 ft) zone, A_{deep} :

$$A_{deep} = A_2 - A_{ev} \quad (\text{Equation 6-67})$$

11) Calculate the average depth of the deep zone (4-8 ft), d_{deep} :

$$d_{deep} = \frac{V_{deep}}{A_{deep}} \quad (\text{Equation 6-68})$$

12) Calculate length of the deep zone, L_{deep} :

$$L_{deep} = \frac{A_{deep}}{W_{deep}} \quad (\text{Equation 6-69})$$

Where:

W_{deep} = width of the deep zone (ft), $W_{deep} = W_2$

Step 6: Ensure design requirements and site constraints are achieved

Check design requirements and site constraints. Modify design geometry until requirements are met. If the chosen site for the basin is inadequate to meet the design requirements, choose a new location for the BMP.

Step 7: Size Outlet Structure

For extended detention wet detention basin, outlet structures shall be designed to provide 12 to 48 hour emptying time for the water quality volume above the permanent pool.

The basin outlet pipe shall be sized, at a minimum, to pass flows greater than the stormwater quality design peak flow for off-line basins or flows greater than the peak runoff discharge rate for the 100-year, 24-hr design storm for on-line basins.

Step 8: Determine Emergency Spillway Requirements

For online basins, an emergency overflow spillway should be sized to pass flows greater than the design peak runoff discharge rate for the 100-yr, 24-hr storm to prevent overtopping of the walls or berms in the event that a blockage of the riser occurs. For offline basins, an emergency spillway or riser should be sized to pass the water quality design storm. For sites where the emergency spillway discharges to a steep slope, an emergency overflow riser, in addition to the spillway should be provided.

Sizing and Geometry

- 1) If there is no extended detention provided, wet detention basins shall be sized to provide a minimum wet pool volume equal to the stormwater quality design volume plus an additional 5% for sediment accumulation. If extended detention is provided above the permanent pool and the basin is designed for water quality treatment only, then the permanent pool volume shall be a minimum of 10 percent of the stormwater quality design volume and the surcharge volume (above the permanent pool) shall make up the remaining 90 percent. If extended detention is provided above the permanent pool and the basin is designed for water quality treatment and peak flow attenuation, then the permanent pool volume shall be equal to the water quality treatment volume and the surcharge volume shall be sized to attenuate peak flows to meet the peak runoff discharge requirements. The extended detention portion of the wet detention basin above the permanent pool, if provided, functions like a dry extended detention (ED) basin (see TCM-1: Dry Extended Detention Basin).
- 2) The wet detention basin shall be divided into two cells separated by a berm or baffle. The first cell shall contain between 25 to 35 percent of the total volume. The berm or baffle volume shall not count as part of the total volume. Intent: The full-length berm or baffle reduces short-circuiting and promotes plug flow.
- 3) Wet detention basins with wetpool volumes less than or equal to 4,000 cubic feet may be single-celled (i.e., no baffle or berm is required).
- 4) Sediment storage shall be provided in the first cell. The sediment storage shall have a minimum depth of 1 foot. This volume shall not be included as part of the required water quality volume.
- 5) The minimum depth of the first cell shall be 4 feet, exclusive of sediment storage requirements. The depth of the first cell may be greater than the depth of the second cell. Average depth shall be between 4 feet and 8 feet.
- 6) The maximum depth of each cell shall not exceed 12 feet (exclusive of sediment storage in the first cell).

- 7) For wet detention basin depths in excess of 6 feet, some form of recirculation shall be provided, such as a fountain or aerator, to prevent stratification, stagnation and low dissolved oxygen conditions.
- 8) Interior side slopes above the permanent pool shall be 4:1 (H:V).
- 9) The edge of the basin shall slope from the surface of the permanent pool to a depth of 12 to 18 inches at a slope of 1:1 or greater. If soil conditions will not support a 1:1 (H:V) slope then the steepest slope that can be supported shall be used or a shallow retaining wall constructed (18 inch max). Beyond the edge of the basin, a bench sloped at 4:1 (H:V) maximum shall extend into the basin to a depth of at least 3 feet. A steeper slope may be used beyond the 3 foot depth to a maximum of 8 feet. Intent: steep slopes at water's edge will minimize very shallow areas that can support mosquitoes.
- 10) At least 25% of the basin area shall be deeper than 3 feet to prevent the growth of emergent vegetation across the entire basin. If greater than 50% of the wet pool area is in excess of 6 feet deep, some form of recirculation shall be provided, such as a fountain or aerator, to prevent stratification, stagnation and low dissolved oxygen conditions.
- 11) A wet detention basin shall have a surface area of not less than 0.3 acres for each acre-foot of permanent pool volume. In addition, extra area needed to provide a design that meets all other provisions of this section shall be provided. Additional surface area in excess of the minimum may be provided. There is no maximum surface area provided that all provisions of this section are met.
- 12) Inlets and outlets shall be placed to maximize the flowpath through the facility. The flowpath length-to-width ratio shall be a minimum of 1.5:1, but a flowpath length-to-width ratio of 2:1 or greater is preferred. The flowpath length is defined as the distance from the inlet to the outlet, as measured at mid-depth. The width at mid-depth can be found as follows: width = (average top width + average bottom width)/2. Intent: a long flowpath length will improve fine sediment removal.
- 13) All inlets shall enter the first cell. If there are multiple inlets, the length-to-width ratio shall be based on the average flowpath length for all inlets.
- 14) The minimum freeboard shall be 1 foot above the maximum water surface elevation (2 feet preferred) for on-line basins and 1 foot above the maximum water surface elevation for on-line basins.
- 15) The maximum residence time for dry weather flows shall be 7 days. Intent: Vector control.

Internal Berms and Baffles

- 1) A berm or baffle shall extend across the full width of the wet detention basin and be keyed into the basin side slopes. If the berm embankments are greater than 4 feet in

- height, the berm must be constructed by excavating a key equal to 50% of the embankment cross-sectional height and width. This requirement may be waived if recommended by a licensed civil engineer for the specific site conditions. The geotechnical investigation must consider the situation in which one of the two cells is empty while the other remains full of water.
- 2) The top of the berm shall extend to the permanent pool surface or be one foot below the permanent pool surface to discourage public access. If the top of the berm is at the water permanent pool surface, the side slopes must be 4H:1V. Berm side slopes may be steeper (up to 3:1) if the berm is submerged one foot.
 - 3) If good vegetation cover is not established on the berm, erosion control measures shall be used to prevent erosion of the berm back-slope when the basin is initially filled.
 - 4) The interior berm or baffle may be a retaining wall provided that the design is prepared and stamped by a licensed civil engineer. If a baffle or retaining wall is used, it shall be submerged one foot below the permanent pool surface to discourage access by pedestrians.
 - 5) Internal earthen berms 6 feet high or less shall have a minimum top width 6 feet or as recommended by a civil engineer.

Water Supply

- 1) Water balance calculations shall be provided to demonstrate that adequate water supply will be present to maintain a pool of water during a drought year when precipitation is 50% of average for the site. Water balance calculations shall include evapotranspiration, infiltration, precipitation, spillway discharge, and dry weather flow (where appropriate).
- 2) Where water balance indicates that losses will exceed inputs, a source of water shall be provided to maintain the basin water surface elevation throughout the year. The water supply shall be of sufficient quantity and quality to not have an adverse impact on the wet detention basin water quality. Water that meets drinking water standards shall be assumed to be of sufficient quality.
- 3) Wet detention basin may be designed as seasonal ponds where the water balance and water supply conditions make it infeasible to sustain a permanent wet detention basin.

Soils Considerations

Wet detention basin implementation in areas with high permeability soils requires liners to increase the chances of maintaining a permanent pool in the basin. Liners can be either synthetic materials or imported lower permeability soils (i.e., clays). The water balance assessment shall determine whether a liner is required.

If low permeability soils are used for the liner, a minimum of 18 inches of native soil amended with good topsoil or compost (one part compost mixed with 3 parts native soil) must be placed over the liner. If a synthetic material is used, a soil depth of 2 feet is recommended to prevent damage to the liner during planting.

Buffer Zone

A minimum of 25 feet buffer shall be provided around the top perimeter of the wet detention basin. The portion of the access road outside of the maximum water level may be included as part of the buffer.

Stormwater Quality Design Features

- 1) Wet detention basins that are located in publicly-accessible or highly visible locations shall include design features that will improve and maintain the quality of water within the BMP at a level suitable for the proposed location and uses of the surrounding area. Typical design features include aeration, pumped circulation, filters, biofilters, and other facilities that operate year-round to remove pollutants and nutrients. Stormwater quality design features will result in higher quality water in the BMP and lower discharges of pollutants downstream.
- 2) Wet detention basins in publicly-accessible or highly visible locations shall have a maintenance plan that includes regular collection and removal of trash from the area within and surrounding the BMP.
- 3) If fencing is required for wet detention basins in publicly-accessible or highly visible locations, the fence can be designed to be aesthetically incorporated into the site and Shrubs (approved, California-adapted species) can be used to hide the fencing. See vegetation section below.

Energy Dissipation

- 1) The inlet to the wet detention basin shall be submerged with the inlet pipe invert a minimum of two feet from the basin bottom (not including sediment storage). The top of the inlet pipe shall be submerged at least 1 foot, if possible. Intent: The inlet is submerged to dissipate energy of the incoming flow. The distance from the bottom is set to minimize resuspension of settled sediments. Alternative inlet designs that accomplish these objectives are acceptable.
- 2) Energy dissipation controls must also be used at the outlet from the wet detention basin unless the basin discharges to a stormwater conveyance system or hardened channel.

Vegetation

A plan shall be prepared that indicates how aquatic, temporarily submerged areas (extended detention wet detention basins) and terrestrial areas will be stabilized with vegetation.

- 1) If the second cell of the wet detention basin is 3 feet or shallower, the bottom area shall be planted with emergent wetland vegetation.
- 2) Emergent aquatic vegetation shall be planted to cover 25-75% of the area of the permanent pool.
- 3) Outside of the basin, native vegetation adapted for site conditions shall be used in non-irrigated sites.
- 4) The area surrounding a wet detention basin must be landscaped to minimize erosion and must adhere to the following criteria so as not to hinder maintenance operations:
- 5) No trees or shrubs may be planted within 15 feet of inlet or outlet pipes or manmade drainage structures such as spillways, flow spreaders, or earthen embankments. Species with roots that seek water, such as willow or poplar, shall not be used within 50 feet of pipes or manmade structures. Weeping willow (*Salix babylonica*) shall not be planted in or near detention basins.
- 6) Prohibited non-native plant species will not be permitted. For more information on invasive weeds, including biology and control of listed weeds, look at the encyclopedias located at the California Department of Food and Agriculture website- http://www.cdfa.ca.gov/phpps/ipc/encyclopedias/encyclopedias_hp.htm or the California Invasive Plant Council website at www.cal-ipc.org.
- 7) A landscape professional should provide recommendations on appropriate plants, fertilizer, mulching applications, and irrigation requirements (if any) to ensure healthy vegetation growth.

Outlet Structure

- 1) An outlet pipe and outlet structure shall be provided. The outlet pipe may be a perforated standpipe strapped to a manhole or placed in an embankment, suitable for extended detention, or may be back-sloped to a catch basin with a grated opening (jail house window) or manhole with a cone grate (birdcage). The grate or birdcage openings provide an overflow route should the basin outlet pipe become clogged.
- 2) For extended detention wet detention basin, outlet structures shall be designed to provide 12 to 48 hour emptying time for the water quality volume above the permanent pool.
- 3) The basin outlet pipe shall be sized, at a minimum, to pass flows greater than the stormwater quality design peak flow for off-line basins or flows greater than the peak runoff discharge rate for the 100-year, 24-hr design storm for on-line basins.

Emergency Spillway

An emergency overflow spillway in addition to the primary overflow outlet (as described above) is required. The emergency spillway shall be sized for flows greater than the peak

100-year 24-hour storm if the basin is designed on-line or, if the basin is designed off-line, the spillway shall be sized for flows greater than the basin design volume (e.g., stormwater quality design volume). The spillway shall be constructed with reinforced concrete and provide for adequate energy dissipation downstream. The spillway shall allow for at least 12 inches of freeboard above the emergency overflow water surface elevation if the basin is on-line. If the basin is off-line, 2 feet of freeboard is preferable.

Spillways shall meet the California Department of Water Resources, Division of Safety of Dams Guidelines for the Design and Construction of Small Embankment Dams (<http://damsafety.water.ca.gov/docs/GuidelinesSmallDams.pdf>). *Intent: Emergency overflow spillways are intended to control the location of basin overtopping and safely direct overflows back into the downstream conveyance system or other acceptable discharge point.*

On-line Basins

- 1) On-line basins must have an emergency overflow spillway to prevent overtopping of walls or berms should blockage of the primary outlet occur based on a downstream risk assessment.
- 2) The overflow spillway must be sized to pass flows greater than the design peak runoff discharge rate for the 100-yr, 24-hr storm.
- 3) The minimum freeboard shall be 1 foot (but preferably at least 2 feet) above the maximum water surface elevation over the emergency spillway.

Off-line Basins

- 1) Off-line basins must have either an emergency overflow spillway or an emergency overflow riser. The emergency overflow must be designed to pass flows greater than the basin design volume (e.g., stormwater quality design volume) directly to the downstream conveyance system or another acceptable discharge point. Where an emergency overflow spillway would discharge to a steep slope, an emergency overflow riser, in addition to the spillway shall be provided. See Appendix E for basin/pond outlet sizing worksheets.
- 2) The emergency overflow spillway shall be armored to withstand the energy of the spillway flows. The spillway shall be constructed of grouted rip-rap.
- 3) The minimum freeboard shall be 1 foot above the maximum water surface elevation over the emergency spillway.

Side Slopes

- 1) Interior side slopes above the stormwater quality design depth and up to the emergency overflow water surface shall be no steeper than 4:1 (H:V), unless stabilization has been approved by a licensed civil engineer.

- 2) Exterior side slopes shall be no steeper than 2:1 (H:V), unless stabilization has been approved by a licensed civil engineer.
- 3) For any slope (interior or exterior) steeper than 2:1 (H:V), a geotechnical investigation and report must be submitted and approved by the City.
- 4) Landscaped slopes must be no steeper than 3:1 (H:V) to allow for maintenance.
- 5) Basin walls may be vertical retaining walls, provided: (a) they are constructed of reinforced concrete, (b) a fence is provided along the top of the wall (see fencing below) or further back, and (c) the design is stamped by a licensed civil engineer.

Embankments

- 1) Earthworks and berm embankments shall be performed in accordance with the latest edition of the “Greenbook Standard Specifications for Public Works Construction”.
- 2) Embankments are earthen slopes or berms used for detaining or redirecting the flow of water.
- 3) Top of berm shall be 2 feet minimum below the stormwater quality design water surface and shall be keyed into embankment a minimum of 1 foot on both sides.
- 4) Typically, the top width of berm embankments are at least 20 feet, but narrower embankments may be plausible if approved by the civil engineer and the City.
- 5) Basin berm embankments must be constructed on native consolidated soil (or adequately compacted and stable fill soils analyzed by a licensed civil engineer) free of loose surface soil materials, roots, and other organic debris.
- 6) The berm embankment shall be constructed of compacted soil (95% minimum dry density, modified proctor method per ASTM D1557), placed in 6-inch lifts.
- 7) Basin berm embankments greater than 4 feet in height must be constructed by excavating a key equal to 50% of the berm embankment cross-sectional height and width. This requirement may be waived if specifically recommended by a licensed civil engineer.
- 8) The berm embankment shall be constructed of compacted soil (95% minimum dry density, modified proctor method per ASTM D1557), placed in 6-inch lifts.
- 9) Low growing native or non-invasive perennial grasses shall be planted on downstream embankment slopes. See vegetation section below.

Fencing

Safety is provided either by fencing of the facility or by managing the contours of the basin to eliminate drop-offs and other hazards.

- 1) If fences are required, fences shall be designed and constructed in accordance with current and relevant policies and typically are required to be located at or above the overflow water surface elevation. Shrubs (approved, California-adapted species) can be used to hide the fencing. See vegetation section above.

Right-of-Way

- 2) Wet detention basins and associated access roads to be maintained by the Cities or Ventura County shall be dedicated in fee or in an easement to the City with appropriate access.

Maintenance Access

- 1) Ownership of the basin and maintenance thereof is the responsibility of the developer/applicant. A maintenance agreement with the City is required to ensure adequate performance and allow the City emergency access to the facilities.
- 2) Maintenance access road(s) shall be provided to the control structure and other drainage structures associated with the basin (e.g., inlet, emergency overflow or bypass structures). Manhole and catch basin lids must be in or at the edge of the access road.
- 3) A graded 16-foot wide access ramp into the basin shall be constructed near the basin outlet. An access ramp is required for removal of sediment with a backhoe or loader and truck. The ramp must extend to the basin bottom to avoid damage to vegetation planted on the basin slope. A 16-foot wide commercial driveway approach shall be provided where curb and gutter front the maintenance ramp.
- 4) All access ramps and roads shall be provided in accordance with the current policies of the Flood Control District.

Vector Control

- 1) A Mosquito Management Plan or Service Contract must be approved or waived by the local Vector Control District for any facility that maintains a pool of water for 72 hours or more.

Operations and Maintenance

General Requirements

Maintenance is of primary importance if extended detention basins are to continue to function as originally designed. A maintenance agreement must be developed with the Flood Control District to ensure adequate performance and allow the County emergency access. Maintenance of the basin is the responsibility of the development, unless otherwise agreed upon.

A specific maintenance plan shall be formulated for each facility outlining the schedule and scope of maintenance operations, as well as the data handling and reporting requirements. The following are general maintenance requirements:

- 1) The basin shall be inspected annually and inspections after major storm events are encouraged (see Appendix I for guidance on facility maintenance inspections). Trash and debris shall be removed as needed, but at least annually prior to the beginning of the wet season (see Appendix I for dry extended detention basin inspection and maintenance checklist).
- 2) Site vegetation shall be maintained as follows:
- 3) Vegetation, large shrubs, or trees that limit access or interfere with basin operation shall be pruned or removed.
- 4) Slope areas that have become bare shall be revegetated and eroded areas shall be regraded prior to being revegetated.
- 5) Grass shall be mowed to 4"-9" high and grass clippings shall be removed.
- 6) Fallen leaves and debris from deciduous plant foliage shall be raked and removed.
- 7) Invasive vegetation, such as Alligatorweed (*Alternanthera philoxeroides*), Halogeton (*Halogeton glomeratus*), Spotted Knapweed (*Centaurea maculosa*), Giant Reed (*Arundo donax*), Castor Bean (*Ricinus communis*), Perennial Pepperweed (*Lepidium latifolium*), and Yellow Starthistle (*Centaurea solstitialis*) must be removed and replaced with non-invasive species. Invasive species shall never contribute more than 25% of the vegetated area. For more information on invasive weeds, including biology and control of listed weeds, look at the encyclopedias located at the California Department of Food and Agriculture website-
- 8) http://www.cdffa.ca.gov/phpps/ipc/encycloweedia/encycloweedia_hp.htm or the California Invasive Plant Council website at www.cal-ipc.org.
- 9) Dead vegetation shall be removed if it exceeds 10% of area coverage. Vegetation shall be replaced immediately to maintain cover density and control erosion where soils are exposed.
- 10) No herbicides or other chemicals shall be used to control vegetation.
- 11) Sediment buildup exceeding 50% of the forebay capacity shall be removed. Sediment from the remainder of the basin shall be removed when 6 inches of sediment accumulates. Sediments shall be tested for toxic substance accumulation in compliance with current disposal requirements if land uses in the catchment include commercial or industrial zones, or if visual or olfactory indications of pollution are noticed. If toxic substances are encountered at concentrations exceeding thresholds of Title 22, Section 66261 of the California Code of Regulations, the sediment must be disposed of in a hazardous waste landfill.

- 12) Following sediment removal activities, replanting, and/or reseeding of vegetation may be required for reestablishment.

Construction Considerations

The use of treated wood or galvanized metal anywhere inside the facility is prohibited. The use of galvanized fencing is permitted if in accordance with the Fencing requirement above

Maintenance Standards

A summary of the routine and major maintenance activities recommended for dry extended detention ponds is shown in Table 6-58. The routine and major maintenance standards listed in Table 6-59 and Table 6-60 are intended to be measures to determine if maintenance actions are required as identified through inspection. They are not intended to be measures of the facility's required condition at all times between inspections. In other words, exceedance of these thresholds or measures at any time between inspections and/or scheduled maintenance does not constitute a violation of these standards. These standards are violated only when an inspection identifies required maintenance action that has not been scheduled before the next regular inspection.

TCM-3: Constructed Wetland

A constructed treatment wetland is a system consisting of a sediment forebay and one or more permanent micro-pools with aquatic vegetation covering a significant portion of the basin. Constructed treatment wetlands typically include components such as an inlet with energy dissipation, a sediment forebay for settling out coarse solids and to facilitate maintenance, a base with shallow sections (1 to 2 feet deep) planted with emergent vegetation, deeper areas or micro pools (3 to 5 feet deep), and a water quality outlet structure. The interactions between the incoming stormwater runoff, aquatic vegetation, wetland soils, and the associated physical, chemical, and biological unit processes are a fundamental part of constructed treatment wetlands.



Constructed Wetlands

Photo Credits: Geosyntec Consultants

Application

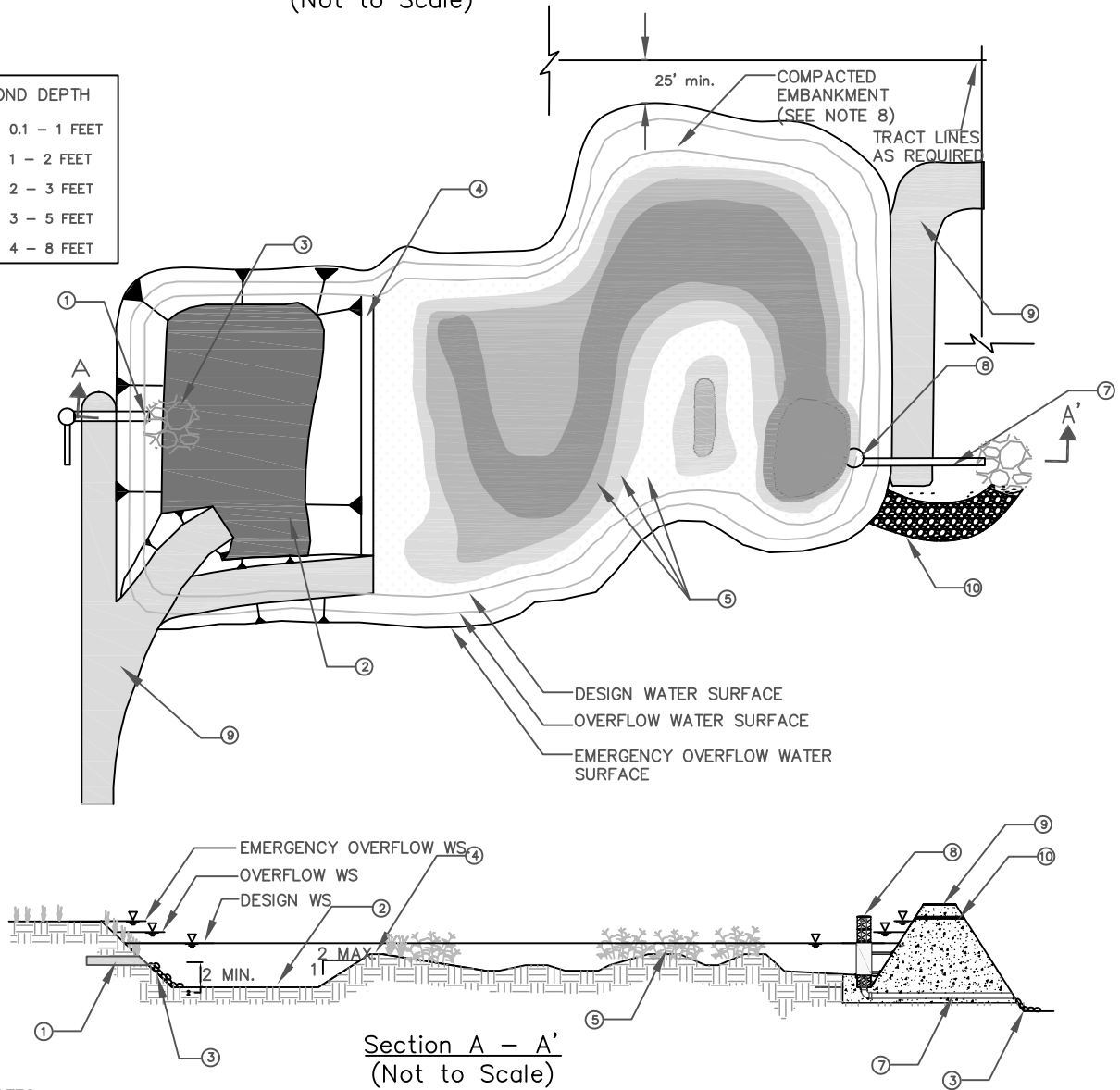
- Regional detention & treatment
- Roads, highways, parking lots, commercial, residential
- Parks, open spaces, and golf courses

Preventative Maintenance

- inspected at a minimum annually and inspections after major storm events
- Pruned or remove vegetation, large shrubs, or trees that limit access or interfere with basin operation
- Remove sediment buildup at inlets and outlets

Plan View
(Not to Scale)

POND DEPTH	
	0.1 - 1 FEET
	1 - 2 FEET
	2 - 3 FEET
	3 - 5 FEET
	4 - 8 FEET



NOTES:

- ① INLET PIPE SHOULD BE SUBMERGED WITH A MINIMUM OF 2' DISTANCE FROM THE BOTTOM
- ② SEDIMENT FOREBAY. FORE BAY VOLUME SHALL EQUAL 10% TO 20% OF TOTAL WETLAND VOLUME. FORE BAY DEPTH SHALL BE 4' MIN TO 8' MAX PLUS AN ADDITIONAL 1' MIN SEDIMENT STORAGE DEPTH.
- ③ RIP RAP APRON OR OTHER INLET ENERGY DISSIPATION.
- ④ BERM AT DESIGN WATER SURFACE ELEVATION OR SUBMERGED 1' BELOW DESIGN WATER SURFACE ELEVATION. EXTEND BERM ACROSS ENTIRE WIDTH OF THE WETLAND.
- ⑤ WETLAND VEGETATION. PLANTING SCHEME MUST BE DESIGNED BY A WETLAND ECOLOGIST.
- ⑥ EMBANKMENT SIDE SLOPES SHALL BE NO STEEPER THAN 2H:1V OUTSIDE AND 3H:1V INSIDE
- ⑦ SIZE OUTLET PIPE TO PASS CAPITAL DESIGN PEAK FLOW FOR ONLINE AND WATER QUALITY PEAK FLOW FOR OFFLINE BASINS.
- ⑧ WATER QUALITY OUTLET STRUCTURE. SEE FIGURE 7-2 AND FIGURE 7-3 FOR DETAILS.
- ⑨ MAINTENANCE RAMP SHOULD BE PAVED. SLOPE SHOULD NOT EXCEED 12%. MAINTENANCE RAMP SHOULD PROVIDE ACCESS TO BOTH THE FOREBAY AND MAIN BASIN.
- ⑩ INSTALL EMERGENCY OVERFLOW SPILWAY AS NEEDED. SEE FIGURE 2-4 FOR DETAILS

Figure 6-21: Constructed Wetland

Limitations

- In theory, there are no limitations on the tributary area size draining to a constructed treatment wetland; however, constructed treatment wetlands usually require considerable land area. Typically, treatment wetlands capture runoff from tributary areas larger than 10 acres and less than 10 square miles. Smaller “pocket” wetlands can be feasible in areas where space is restricted.
- If the constructed treatment wetland is not used for flow control, the wetland must not interfere with flood control functions of existing conveyance and detention structures.
- Constructed treatment wetlands shall not be permitted in areas with site slopes greater than 7% or within 200 feet (on the uphill side) of a steep slope hazard area or a mapped landslide area unless a geotechnical investigation and report is completed by a licensed civil engineer.
- Constructed treatment wetlands require a regular source of water (base flow) to maintain wetland vegetation and associated treatment processes. If adequate base flow is not available year-round, supplemental water may be needed during the summer months to maintain adequate base flow.

Design Criteria

The main challenge associated with constructed treatment wetlands is maintaining base flow to support vegetation. Constructed wetlands should be designed according to the requirements listed in Table 6-24 and outlined in the section below. Constructed wetland BMP sizing worksheets are presented in Appendix E.

Table 6-24: Constructed Wetland Design Criteria

Design Parameter	Unit	Design Criteria
Stormwater quality design volume, SQDV	acre-feet	See Section 2 and Appendix E for calculating SQDV.
Permanent pool volume	%	75% of SQDV
Drawdown time for extended detention (over permanent pool)	hours	48 ; 12 for 50% SQDV (minimum)
Sediment forebay volume	%	30 to 50% of permanent pool surface area
Depth of sediment forebay	feet	2-4 (1 foot of sediment storage required)
Wetland zone volume	%	50-70% of permanent pool surface area
Depth of wetland basin	feet	0.5 to 1.0 (30 to 50% should be 0.5 feet deep)

Design Parameter	Unit	Design Criteria
Wetland (littoral zone) bottom slope	%	10 maximum
Maximum residence time	Days	7 (dry weather)
Freeboard (minimum)	inches	12
Flow path length to width ratio	L:W	2:1, larger preferred
Side slope (maximum)	H:V	4:1 Interior; 3:1 Exterior
Vegetation Type	--	Varies see vegetation section below
Vegetation Height	--	Varies see vegetation section below
Buffer zone (minimum)	feet	25
Maintenance access ramp width	feet	16
Maintenance access ramp slope	H:V	10:1 or flatter
Minimum outflow device diameter	inches	18

Sizing

In most cases, the constructed treatment wetland permanent pool shall be sized to be greater than or equal to the stormwater quality design volume. If extended detention is provided above the permanent pool and the wetland is designed for water quality treatment only, then the permanent pool volume shall be a minimum of 80 percent of the stormwater quality design volume and the surcharge volume (above the permanent pool) shall make up the remaining 20 percent and provide at least 12 hours of detention. If extended detention is provided and the basin is designed for water quality treatment and peak flow attenuation, then the permanent pool volume shall be equal to the water quality treatment volume and the surcharge volume shall be sized to attenuate peak flows to meet the peak runoff discharge requirements. The extended detention portion of the wetland above the permanent pool, if provided, functions like a dry extended detention (ED) basin (see [VEG-5: Dry Extended Detention Basin](#)).

Step 1: Calculate the design volume

Constructed wetlands shall be sized to be greater than or equal to the SQDV volume (see [Section 2](#) and Appendix E).

Step 2: Determine the Wetland Location, Wetland Type and Preliminary Geometry Based on Site Constraints

Based on site constraints, determine the wetland geometry and the storage available by developing an elevation-storage relationship for the wetland. The equations provided below assume a trapezoidal geometry for cell 1 (Forebay) and cell 2, and assumes that the wetland does not have extended detention.

- 1) Calculate the width of the wetland footprint, W_{tot} , as follows:

$$W_{tot} = \frac{A_{tot}}{L_{tot}} \quad \text{(Equation 6-70)}$$

Where:

$$A_{tot} = \text{total surface area of the wetland footprint (ft}^2\text{)}$$

$$L_{tot} = \text{total length of the wetland footprint (ft)}$$

- 2) Calculate the length of the water quality volume surface area including the internal berm but excluding the freeboard, L_{wq-tot} :

$$L_{wq-tot} = L_{tot} - 2Zd_{fb} \quad \text{(Equation 6-71)}$$

Where:

$$Z = \text{interior side slope as length per unit height}$$

$$d_{fb} = \text{freeboard depth}$$

- 3) Calculate the width of the water quality volume surface area including the internal berm but excluding freeboard, W_{wq-tot} :

$$W_{wq-tot} = W_{tot} - 2Zd_{fb} \quad \text{(Equation 6-72)}$$

- 4) Calculate the total water quality volume surface area including the internal berm and excluding freeboard, A_{wq-tot} :

$$A_{wq-tot} = L_{wq-tot} \times W_{wq-tot} \quad \text{(Equation 6-73)}$$

- 5) Calculate the area of the berm, A_{berm} :

$$A_{berm} = W_{berm} \times L_{berm} \quad \text{(Equation 6-74)}$$

Where:

$$W_{berm} = \text{width of the internal berm}$$

$$L_{berm} = \text{length of the internal berm}$$

- 6) Calculate the water quality surface area excluding the internal berm and freeboard, A_{wq} :

$$A_{wq} = A_{wq = tot} - A_{berm} \quad (\text{Equation 6-75})$$

Step 3: Determine Dimensions of Forebay

30-50% of the SQDV is required to be within the active volume of forebay.

- 1) Calculate the active volume of forebay, V_1 :

$$V_1 = \frac{SQDV \times \%V_1}{100} \quad (\text{Equation 6-76})$$

Where:

$$\%V_1 = \text{percent of SQDV in forebay (\%)}$$

- 2) Calculate the surface area for the active volume of forebay, A_1 :

$$A_1 = \frac{V_1}{d_1} \quad (\text{Equation 6-77})$$

Where:

$$d_1 = \text{average depth for the active volume of forebay (2 -4 ft) (ft)}$$

- 3) Calculate the length of forebay, L_1 . Note, inlet and outlet should be configured to maximize the residence time.

$$L_1 = \frac{A_1}{W_1} \quad (\text{Equation 6-78})$$

Where:

$$W_1 = \text{width of forebay (ft), } W_1 = W_{av-tot} = L_{berm}$$

Step 4: Determine Dimensions of Cell 2

Cell 2 will consist of the remainder of the basin's active volume.

- 1) Calculate the active volume of Cell 2, V_2 :

$$V_2 = SQDV - V_1 \quad (\text{Equation 6-79})$$

- 2) Calculate the surface area of Cell 2, A_2 :

$$A_2 = A_{wq} - A_1 \quad (\text{Equation 6-80})$$

- 3) Calculate the top length of Cell 2, L_2 :

$$L_2 = \frac{A_2}{W_2} \quad (\text{Equation 6-81})$$

Where:

$$W_2 = \text{width of Cell 2 (ft), } W_2 = W_1 = W_{\text{wq-tot}} = L_{\text{berm}}$$

- 4) Verify that the length-to-width ratio of Cell 2, LW_2 , is at least 3:1 with $\geq 4:1$ preferred. If the length-to-width ratio is less than 3:1, modify input parameters until a ratio of at least 3:1 is achieved. If the input parameters cannot be modified as a result of site constraints, another site for the pond should be chosen.

$$LW_2 = \frac{L_2}{W_2} \quad (\text{Equation 6-82})$$

- 5) Calculate the very shallow zone surface area, A_{vs} :

$$A_{vs} = \frac{A_2 \cdot \% A_{vs}}{100} \quad (\text{Equation 6-83})$$

Where:

$$\%A_{vs} = \text{percent of surface area of very shallow zone}$$

- 6) Calculate the volume of the shallow zone, V_{vs} :

$$V_{vs} = A_{vs} \cdot d_{vs} \quad (\text{Equation 6-84})$$

Where:

$$d_{vs} = \text{average depth of the very shallow zone (0.1 – 1 ft)}$$

- 7) Calculate the length of the very shallow zone, L_{vs} :

$$L_{vs} = \frac{A_{vs}}{W_{vs}} \quad (\text{Equation 6-85})$$

Where:

$$W_{vs} = \text{width of the very shallow zone (ft), } W_{vs} = W_2$$

- 8) Calculate the surface area of the shallow zone, A_s :

$$A_s = \frac{A_2 \cdot \% A_s}{100} \quad (\text{Equation 6-86})$$

Where:

$\%A_s$ = percent of surface area of shallow zone

9) Calculate the volume of the shallow zone, V_s :

$$V_s = A_s \bullet d_s \quad (\text{Equation 6-87})$$

Where:

d_s = average depth of shallow zone (1 - 3 ft)

10) Calculate length of the shallow zone, L_s :

$$L_s = \frac{A_s}{W_s} \quad (\text{Equation 6-88})$$

Where:

W_s = width of the shallow zone (ft), $W_s = W_2$

11) Calculate the surface area of the deep zone, A_{deep} :

$$A_{deep} = A_2 - A_{vs} - A_s \quad (\text{Equation 6-89})$$

12) Calculate the volume of the deep zone, V_{deep} :

$$V_{deep} = V_2 - V_{vs} - V_s \quad (\text{Equation 6-90})$$

13) Calculate the average depth of the deep zone (3-5 ft), d_{deep} :

$$d_{deep} = \frac{V_{deep}}{A_{deep}} \quad (\text{Equation 6-91})$$

14) Calculate length of the deep zone, L_{deep} :

$$L_{deep} = \frac{A_{deep}}{W_{deep}} \quad (\text{Equation 6-92})$$

Where:

W_{deep} = width of the deep zone (ft), $W_{deep} = W_2$

Step 5: Ensure design requirements and site constraints are achieved

Check design requirements and site constraints. Modify design geometry until requirements are met. If the chosen site for the basin is inadequate to meet the design requirements, choose a new location or alternative treatment BMP.

Step 6: Size Outlet Structure

For wetlands with detention, the outlet structures shall be designed to provide 12 hours emptying time for the water quality volume or the required detention necessary for achieving the peak runoff discharge requirements if the extended detention is designed for flow attenuation.

The wetland outlet pipe shall be sized, at a minimum, to pass flows greater than the stormwater quality design peak flow for on-line basins or flows greater than the peak runoff discharge rate for the 100-year, 24-hr design storm for on-line basins.

Step 7: Determine Emergency Spillway Requirements

For online basins, an emergency overflow spillway should be sized to pass flows greater than the design peak runoff discharge rate for the 100-yr, 24-hr storm in order to prevent overtopping of the walls or berms in the event that a blockage of the riser occurs. For offline basins, an emergency spillway or riser should be sized to pass the 100-yr, 24-hr post-development peak storm water runoff discharge rate directly to the downstream conveyance system or another acceptable discharge point. For sites where the emergency spillway discharges to a steep slope, an emergency overflow riser, in addition to the spillway should be provided.

Sizing and Geometry

In most cases, the constructed treatment wetland permanent pool shall be sized to be greater than or equal to the stormwater quality design volume. If extended detention is provided above the permanent pool and the wetland is designed for water quality treatment only, then the permanent pool volume shall be a minimum of 80 percent of the stormwater quality design volume and the surcharge volume (above the permanent pool) shall make up the remaining 20 percent and provide at least 12 hours of detention. If extended detention is provided and the basin is designed for water quality treatment and peak flow attenuation, then the permanent pool volume shall be equal to the water quality treatment volume and the surcharge volume shall be sized to attenuate peak flows to meet the peak runoff discharge requirements. A constructed treatment wetland design worksheets are presented in Appendix E. The extended detention portion of the wetland above the permanent pool, if provided, functions like a dry extended detention (ED) basin (see [TCM-1: Dry Extended Detention Basin](#)).

- 1) Constructed treatment wetlands shall consist of at least two cells including a sediment forebay and a wetland basin.
- 2) The sediment forebay must contain between 10 and 20 percent of the total basin volume.
- 3) The depth of the sediment forebay shall be between 4 and 8 feet.
- 4) One foot of sediment storage shall be provided in the sediment forebay.

- 5) The “berm” separating the two basins shall be uniform in cross-section and shaped such that its downstream side gradually slopes to the main wetland basin.
- 6) The top of berm shall be either at the stormwater quality design water surface or submerged 1 foot below the stormwater quality design water surface, as with wet retention basins. Correspondingly, the side slopes of the berm must meet the following criteria:
 - a. If the type of the berm is at the stormwater quality design water surface, the berm side slopes shall be no steeper than 4H:1V.
 - b. If the top of berm is submerged 1 foot, the upstream side slope may be a max of 3H:1V.
- 7) The constructed treatment wetlands shall be designed with a “naturalistic” shape and a range of depths intermixed throughout the wetland basin to a maximum of 5 feet.

Depth Range (feet)	Percent by Area
0.1 to 1	15
1 to 3	55
3 to 5	30

- 8) The flowpath length-to-width ratio shall be a minimum of 2:1, but preferably at least 4:1 or greater. *Intent: a high flow path length to width ratio will maximize fine sediment removal.*
- 9) The minimum freeboard shall be 1 foot above the maximum water surface elevation for on-line basins (2 feet preferable) and 1 foot above the maximum water surface elevation for on-line basins.
- 10) Wetland pools shall be designed such that the residence time for dry weather flows is no greater than 7 days. *Intent: Minimize vector and stagnation issues.*

Water Supply

Water balance calculations shall be provided to demonstrate that adequate water supply will be present to maintain a permanent pool of water during a drought year when precipitation is 50% of average for the site. Water balance calculations shall include evapotranspiration, infiltration, precipitation, spillway discharge, and dry weather flow (where appropriate).

Where water balance indicates that losses will exceed inputs, a source of water shall be provided to maintain the wetland water surface elevation throughout the year. The water supply shall be of sufficient quantity and quality to not have an adverse impact on the

wetland water quality. Water that meets drinking water standards shall be assumed to be of sufficient quality.

Soils Considerations

- 1) Implementation of constructed treatment wetlands in areas with high permeability soils (>0.1 in/hr) requires liners to increase the chances of maintaining permanent pools and/or micro-pools in the basin. Liners can be either synthetic materials or imported lower permeability soils (i.e., clays). The water balance assessment shall determine whether a liner is required. The following conditions can be used as a guideline.
- 2) The wetland basin must retain water for at least 10 months of the year.
- 3) The sediment forebay must retain at least 3 feet of water year-round.
- 4) Many wetland plants can adapt to periods of summer drought, so a limited drought period is allowed in the wetland basin. This may allow for a soil liner rather than a geosynthetic liner. The sediment forebay must retain water year-round for presettling to be effective.
- 5) If low permeability soils are used for the liner, a minimum of 18 inches of native soil amended with good topsoil or compost (one part compost mixed with 3 parts native soil) must be placed over the liner (see soil amendment Section 5.10). If a synthetic material is used, a soil depth of 2 feet is recommended to prevent damage to the liner during planting.

Buffer Zone

A minimum of 25 feet buffer shall be provided around the top perimeter of the constructed treatment wetlands.

Energy Dissipation

- 1) The inlet to the constructed treatment wetland shall be submerged with the inlet pipe invert a minimum of two feet from the cell bottom (not including sediment storage). The top of the inlet pipe shall be submerged at least 1 foot, if possible. *Intent: the inlet is submerged to dissipate energy of the incoming flow. The distance from the bottom is set to minimize resuspension of settled sediments. Alternative inlet designs that accomplish these objectives are acceptable.*
- 2) Energy dissipation controls must also be used at the outlet/spillway from the constructed treatment wetlands unless the wetland discharges to a stormwater conveyance system or hardened channel.

Vegetation

- 1) The wetland cell(s) shall be planted with emergent wetland plants following the recommendations of a wetlands specialist.
- 2) Landscaping outside of the basin is required for all constructed wetlands and must adhere to the following criteria so as not to hinder maintenance operations:
 - a. No trees or shrubs may be planted within 15 feet of inlet or outlet pipes or manmade drainage structures such as spillways, flow spreaders, or earthen embankments. Species with roots that seek water, such as willow or poplar, shall not be used within 50 feet of pipes or manmade structures. Weeping willow (*Salix babylonica*) shall not be planted in or near detention basins.
 - b. Prohibited non-native plant species will not be permitted. For more information on invasive weeds, including biology and control of listed weeds, look at the encycloweedia located at the California Department of Food and Agriculture website- http://www.cdfa.ca.gov/phpps/ipc/encycloweedia/encycloweedia_hp.htm or the California Invasive Plant Council website at www.cal-ipc.org.
- 3) Project-specific planting recommendations should be provided by a wetland ecologist or a qualified landscape professional including recommendations on appropriate plants, fertilizer, mulching applications, and irrigation requirements (if any) to ensure healthy vegetation growth.

Outlet Structure

An outlet pipe and outlet structure shall be provided. The outlet pipe may be a perforated standpipe strapped to a manhole or placed in an embankment, suitable for extended detention, or may be back-sloped to a catch basin with a grated opening (jail house window) or manhole with a cone grate (birdcage). The grate or birdcage openings provide an overflow route should the basin outlet pipe become clogged. The outlet should be protected from clogging by a skimmer shield that starts at the bottom of the permanent pool and extends above the SQDV depth. A trash rack is also required.

For wetlands with detention, the outlet structures shall be designed to provide 12 hours emptying time for the water quality volume or the required detention necessary for achieving the peak runoff discharge requirements if the extended detention is designed for flow attenuation.

The wetland outlet pipe shall be sized, at a minimum, to pass flows greater than the stormwater quality design peak flow for on-line basins or flows greater than the peak runoff discharge rate for the 100-year, 24-hr design storm for on-line basins.

See the dry extended detention section (see [ST-1: Dry Extended Detention Basin](#)) and Appendix E for further detail on outlet sizing.

Emergency Spillway

An emergency overflow spillway in addition to the primary overflow outlet (as described above) is required. The emergency spillway shall be sized for flows greater than the peak 100-year 24-hour storm if the basin is designed on-line or, if the basin is designed on-line, the spillway shall be sized for flows greater than the basin design volume (e.g., stormwater quality design volume). The spillway shall be constructed with reinforced concrete and provide for adequate energy dissipation downstream. The spillway shall allow for at least 12 inches of freeboard above the emergency overflow water surface elevation if the basin is on-line. If the basin is on-line, 2 feet of freeboard is preferable.

Spillways shall meet the California Department of Water Resources, Division of Safety of Dams Guidelines for the Design and Construction of Small Embankment Dams (<http://damsafety.water.ca.gov/docs/GuidelinesSmallDams.pdf>). *Intent: Emergency overflow spillways are intended to control the location of basin overtopping and safely direct overflows back into the downstream conveyance system or other acceptable discharge point.*

On-line Basins

- 1) On-line basins must have an emergency overflow spillway to prevent overtopping of walls or berms should blockage of the primary outlet occur based on a downstream risk assessment.
- 2) The overflow spillway must be sized to pass flows greater than the design peak runoff discharge rate for the 100-yr, 24-hr storm.
- 3) The minimum freeboard shall be 1 foot (but preferably at least 2 feet) above the maximum water surface elevation over the emergency spillway.

Off-line Basins

- 1) Off-line basins must have either an emergency overflow spillway or an emergency overflow riser. The emergency overflow must be designed to pass the 100-yr 24-hr post-development peak stormwater runoff discharge rate (see Appendix E for further detail) directly to the downstream conveyance system or another acceptable discharge point. Where an emergency overflow spillway would discharge to a steep slope, an emergency overflow riser, *in addition* to the spillway shall be provided.
- 2) The emergency overflow spillway shall be armored to withstand the energy of the spillway flows. The spillway shall be constructed of grouted rip-rap.
- 3) The minimum freeboard shall be 1 foot above the maximum water surface elevation over the emergency spillway.

Side Slopes

- 1) Interior side slopes above the stormwater quality design depth and up to the emergency overflow water surface shall be no steeper than 4:1 (H:V), unless stabilization has been approved by a licensed civil engineer and the City.
- 2) Exterior side slopes shall be no steeper than 2:1 (H:V), unless stabilization has been approved by a licensed civil engineer and the City.
- 3) For any slope (interior or exterior) steeper than 2:1 (H:V), a geotechnical investigation and report must be submitted and approved by the City.
- 4) Landscaped slopes must be no steeper than 3:1 (H:V) to allow for maintenance.
- 5) Basin walls may be vertical retaining walls, provided: (a) they are constructed of reinforced concrete, (b) a fence is provided along the top of the wall (see fencing below) or further back, and (c) the design is stamped by a licensed civil engineer and approved by the City.

Embankments

- 1) Earthworks and berm embankments shall be performed in accordance with the latest edition of the “Greenbook Standard Specifications for Public Works Construction”.
- 2) Embankments are earthen slopes or berms used for detaining or redirecting the flow of water.
- 3) Top of berm shall be 2 feet minimum below the stormwater quality design water surface and shall be keyed into embankment a minimum of 1 foot on both sides.
- 4) Typically, the top width of berm embankments are at least 20 feet, but narrower embankments may be plausible if approved by the civil engineer and the City.
- 5) Basin berm embankments must be constructed on native consolidated soil (or adequately compacted and stable fill soils analyzed by a licensed civil engineer) free of loose surface soil materials, roots, and other organic debris.
- 6) Basin berm embankments greater than 4 feet in height must be constructed by excavating a key equal to 50% of the berm embankment cross-sectional height and width. This requirement may be waived if specifically recommended by a licensed civil engineer.
- 7) The berm embankment shall be constructed of compacted soil (95% minimum dry density, modified proctor method per ASTM D1557), placed in 6-inch lifts.
- 8) Low growing native or non-invasive perennial grasses shall be planted on downstream embankment slopes. See vegetation section below.

Fencing

Safety is provided either by fencing of the facility or by managing the contours of the basin to eliminate drop-offs and other hazards.

- 1) Provide fencing in accordance with the local permitting agency's requirements. Perimeter fencing (minimum height of 42 inches) shall be required on all basins exceeding two feet in depth or where interior side slopes are steeper than 6:1 (H:V).
- 2) If fences are required, fences shall be designed and constructed in accordance with current policies of the local permitting agency and must be located at or above the overflow water surface elevation. Shrubs (approved, California-adapted species) can be used to hide the fencing. See vegetation section above.

Right-of-Way

- 1) Constructed treatment wetlands and associated access roads to be maintained by the City shall be dedicated in fee or in an easement to the City with appropriate access.

Maintenance Access

- 1) Ownership of the basin and maintenance thereof is the responsibility of the developer/applicant. A maintenance agreement with the City is required to ensure adequate performance and allow the City emergency access to the facilities.
- 2) Maintenance access road(s) shall be provided to the control structure and other drainage structures associated with the basin (e.g., inlet, emergency overflow or bypass structures). Manhole and catch basin lids must be in or at the edge of the access road.
- 3) A graded 16-foot wide access ramp into the basin shall be constructed near the basin outlet. An access ramp is required for removal of sediment with a backhoe or loader and truck. The ramp must extend to the basin bottom to avoid damage to vegetation planted on the basin slope. A 16-foot wide commercial driveway approach shall be provided where curb and gutter front the maintenance ramp.
- 4) All access ramps and roads shall be provided in accordance with the current policies of the Flood Control District.

Vector Control

- 1) A Mosquito Management Plan or Service Contract must be approved or waived by the local Vector Control District for any facility that maintains a pool of water for 72 hours or more.

Construction Considerations

The use of treated wood or galvanized metal anywhere inside the facility is prohibited. The use of galvanized fencing is permitted if in accordance with the Fencing requirement above.

Operations and Maintenance

Maintenance is of primary importance if constructed treatment wetlands basins are to continue to function as originally designed. A specific maintenance plan shall be formulated for each facility outlining the schedule and scope of maintenance operations, as well as the data handling and reporting requirements. The following are general maintenance requirements:

- 1) The constructed treatment wetlands basin shall be inspected twice annually or more frequently, and inspections after major storm events are encouraged (see Appendix I for a constructed treatment wetland inspection and maintenance checklist). Trash and debris shall be removed as needed, but at least annually prior to the beginning of the wet season.
- 2) Site vegetation shall be maintained as frequently as necessary to maintain the aesthetic appearance of the site and to prevent clogging of outlets, creation of dead volumes, and barriers to mosquito fish to access pooled areas, and as follows:
- 3) Vegetation, large shrubs, or trees that limit access or interfere with basin operation shall be pruned or removed.
- 4) Slope areas that have become bare shall be revegetated and eroded areas shall be regraded prior to being revegetated.
- 5) Invasive vegetation, such as Alligatorweed (*Alternanthera philoxeroides*), Halogeton (*Halogeton glomeratus*), Spotted Knapweed (*Centaurea maculosa*), Giant Reed (*Arundo donax*), Castor Bean (*Ricinus communis*), Perennial Pepperweed (*Lepidium latifolium*), and Yellow Starthistle (*Centaurea solstitialis*) must be removed and replaced with non-invasive species. Invasive species shall never contribute more than 25% of the vegetated area. For more information on invasive weeds, including biology and control of listed weeds, look at the encyclopedias located at the California Department of Food and Agriculture website-
- 6) http://www.cdfa.ca.gov/phpps/ipc/encycloweedia/encycloweedia_hp.htm or the California Invasive Plant Council website at www.cal-ipc.org.
- 7) Dead vegetation shall be removed if it exceeds 10% of area coverage. This does not include seasonal die-back where roots would grow back later in colder areas. Vegetation shall be replaced immediately to maintain cover density and control erosion where soils are exposed.

- 8) Sediment buildup exceeding 6 inches over the storage capacity in the first cell shall be removed. Sediments shall be tested for toxic substance accumulation in compliance with current disposal requirements if land uses in the catchment include commercial or industrial zones, or if visual or olfactory indications of pollution are noticed. If toxic substances are encountered at concentrations exceeding thresholds of Title 22, Section 66261 of the California Code of Regulations, the sediment must be disposed of in a hazardous waste landfill. Clean forebay every two years at a minimum, to avoid accumulation in main wetland area. Environmental regulations and permits may be involved with the removal of wetland deposits. When the main wetland area needs to be cleaned, it is suggested that the main area be cleaned one half at a time with at least one growing season in between cleanings. This will help to preserve the vegetation and enable the wetland to recover more quickly from the cleaning.
- 9) Repair erosion to banks and bottom as required.
- 10) Inspect outlet for clogging a minimum of twice a year, before and after the rainy season, after large storms, and more frequently if needed. Correct observed problems as necessary.
- 11) Following sediment removal activities, replanting, and/or reseeding of vegetation may be required for reestablishment.

TCM-4: Sand Filters

Sand filters operate much like bioretention facilities; however, instead of filtering stormwater through engineered soils, stormwater is filtered through a constructed sand bed with an underdrain system. Runoff enters the filter and spreads over the surface. As flows increase, water backs up on the surface of the filter where it is held until it can percolate through the sand. The treatment pathway is vertical (downward through the sand) to a perforated underdrain system that is connected to the downstream storm drainage system or to an infiltration facility. As stormwater passes through the sand, pollutants are trapped in the small pore spaces between sand grains or are adsorbed to the sand surface.



Application

- Adjacent to parking lots
- Road medians and shoulders
- Within open areas or play fields

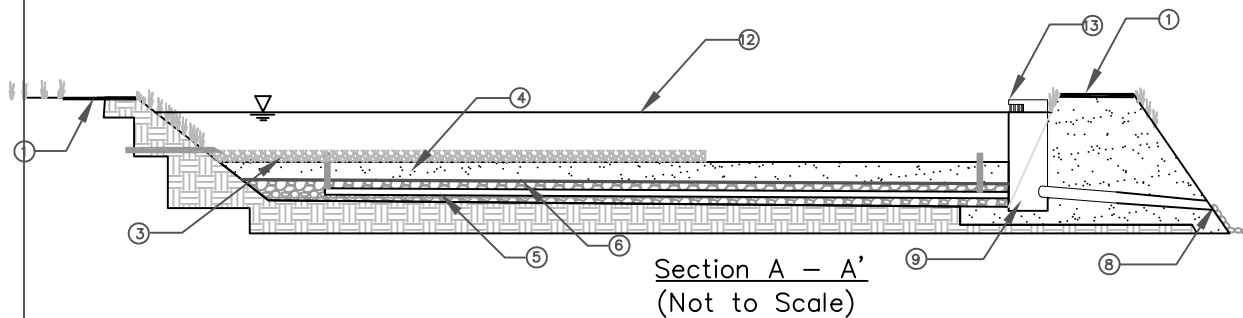
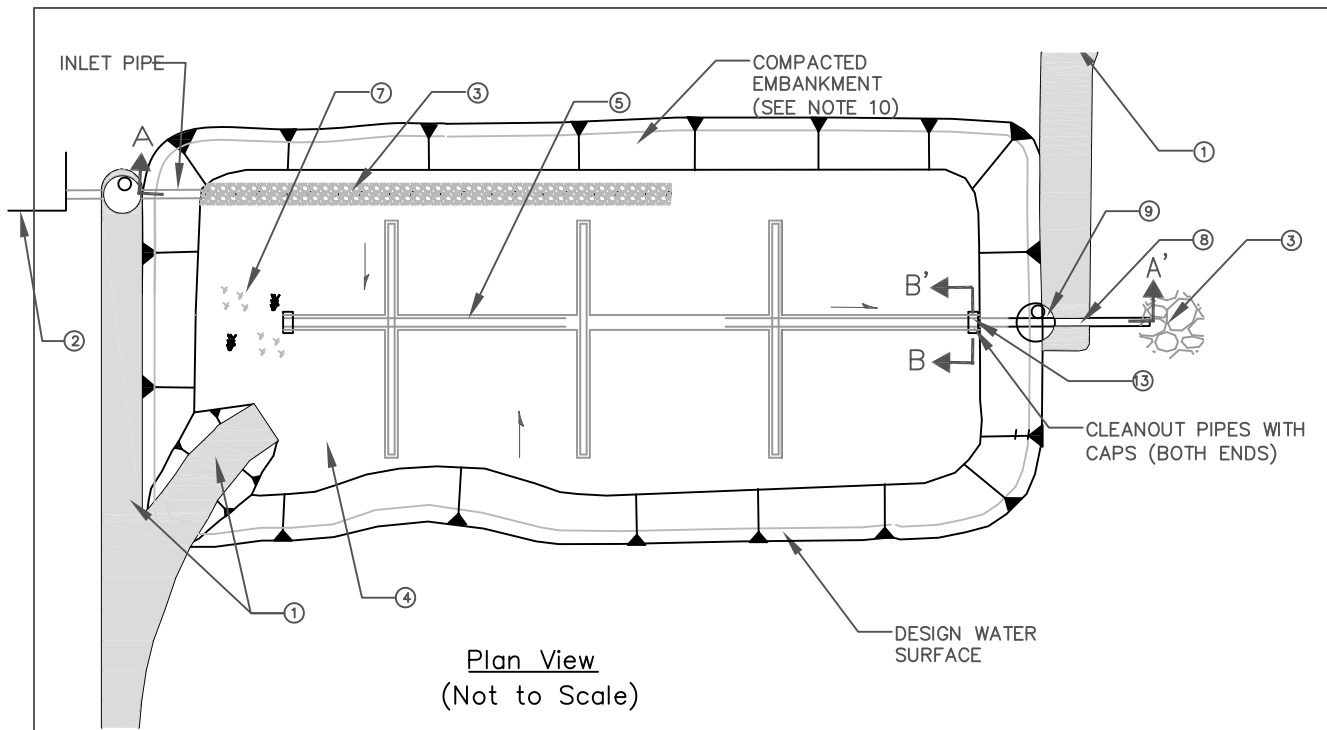
Preventative Maintenance

- Remove trash and debris, minor sediment accumulation, and obstructions near inlet and outlet structures
- Replace top 2” – 4” of sand
- Mow or weed surface of filter



Sand filters connected to impervious surfaces

Photo Credits: Geosyntec Consultants



NOTES:

- ① INSTALL MAINTENANCE ACCESS ROAD AND RAMP TO BOTTOM OF SAND FILTER. MAINTENANCE RAMP SHOULD BE PAVED. SLOPE SHOULD NOT EXCEED 10H:1V.
- ② UPSTREAM PRETREATMENT SHALL BE PROVIDED. IN THE ABSENCE OF PRETREATMENT, INCLUDE SEDIMENT FOREBAY WITH VOLUME EQUAL TO 10-20% OF TOTAL SAND FILTER VOLUME.
- ③ FLOW SPREADER TO EVENLY DISTRIBUTE FLOWS ALONG AT LEAST 20% OF PERIMETER.
- ④ FILTER BED SHALL BE A 24" MINIMUM SAND LAYER ON TOP OF 8" MINIMUM GRAVEL OR DRAIN ROCK BACKFILL.
- ⑤ 6" MINIMUM DIAMETER PERFORATED PIPE UNDERDRAIN SURROUNDED BY GRAVEL BEDDING. INSTALL AT 0.5% MINIMUM SLOPE
- ⑥ INSTALL GEOTEXTILE FABRIC OVERLAIN BY 1" OF DRAIN ROCK OR TRANSITIONALLY GRADED AGGREGATE BETWEEN SAND AND GRAVEL LAYER.
- ⑦ VEGETATION MAY BE PLANTED ON TOP OF FILTER BED. NO TOP SOIL SHALL BE ADDED TO FILTER BED.
- ⑧ SIZE OUTLET PIPE STRUCTURE TO PASS WATER QUALITY DESIGN STORM AND INCLUDE AN EMERGENCY OVERFLOW.
- ⑨ EMERGENCY OVERFLOW STRUCTURE.
- ⑩ INTERIOR SIDE SLOPES SHOULD NOT EXCEED 4:1 UNLESS APPROVED BY AN ENGINEER. EXTERIOR SIDE SLOPES SHALL NOT EXCEED 3:1 WITHOUT A SUPPORTING GEOTECHNICAL REPORT.
- ⑪ ¾" - 1½" WASHED DRAIN ROCK OR GRAVEL LAYER.
- ⑫ DESIGN WATER SURFACE. 6' MAX PONDING DEPTH.
- ⑬ AFFIX PERMANENT IDENTIFICATION TAG.

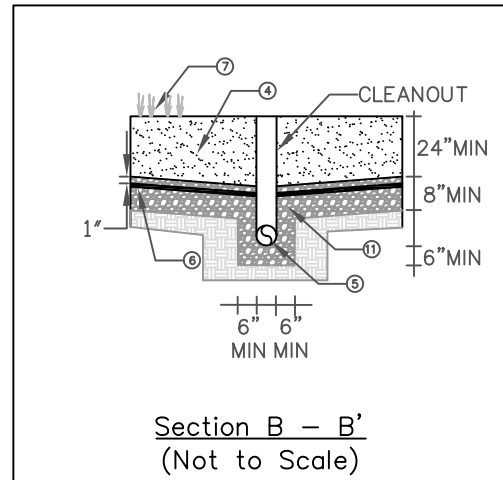


Figure 6-22: Sand Filter	

Limitations

Limitations for sand filters include:

- The sand filter should be located away from trees producing leaf litter or areas contributing significant eroded sediment to prevent clogging.
- Sand filters are should not be used in areas where heavy sediment loads are expected or in tributary areas that are not fully stabilized; high sediment loading rates may cause premature clogging of the filter. Pretreatment is essential.
- Site must have adequate relief between land surface and stormwater conveyance system to permit vertical percolation through the sand filter and collection and conveyance in the underdrain to stormwater conveyance system; four feet of elevation difference is recommended between the inlet and outlet of the filter.
- Not applicable in areas of high groundwater.
- Does not provide quantity control.

Design Criteria

The main challenge associated with sand filters is maintaining the filtration capacity, which is critical to the performance of this BMP. If flows entering the sand filter have high sediment concentrations, clogging of the sand filter is likely. Contribution of eroded soils or leaf litter may also reduce the infiltration and associated treatment capacity of the structure. Sand filters should be designed according to the requirements listed in Table 6-22 and outlined in the section below. BMP sizing worksheets are presented in Appendix E.

Table 6-25: Sand Filter Design Criteria

Design Parameter	Unit	Design Criteria
Stormwater quality design volume, SQDV	acre-feet	See Section 2 and Appendix E for calculating SQDV.
Max depth at SQDV	feet	3
Freeboard (minimum)	feet	1
Length to width ratio	L:W	2:1 (larger preferred)
Filter bed depth	inches	18 inches sand; 9 inches gravel
Max ponding depth above filter bed	feet	6
Drawdown time	Hours	?
Hydraulic conductivity of	in/hr	1 (equal to 2 ft/day)

Design Parameter	Unit	Design Criteria
sand, k		
Underdrains		6 inch minimum diameter; 0.5% minimum slope
Side slopes	H:V	4:1 (H:V) interior and 3:1 (H:V) exterior, unless stabilization has been approved by a licensed geotechnical engineer; or vertical concrete walls
Maintenance access ramp width	ft	16
Maintenance access ramp slope	H:V	10:1 or flatter

Pretreatment

Pretreatment must be provided for sand filters in order to reduce the sediment load entering the filter. Pretreatment refers to design features that provide settling of large particles before runoff reaches the filter, easing the long-term maintenance burden. To ensure that pretreatment mechanisms are effective, designers shall incorporate pretreatment such as a biofiltration BMP, proprietary device, or sedimentation forebay. BMPs that are described in the 2010 TGM that may serve this purpose include:

For design specification of selected pre-treatment devices, refer to:

- [VEG-3: Vegetated swale](#)
- [VEG-4: Vegetated filter strip](#)
- [PROP-1: Hydrodynamic separation device](#)

Sizing Criteria

Background

Sand filter design is based on Darcy's law:

$$Q = KiA \quad \text{(Equation 6-93)}$$

Where:

- Q = water quality design flow (cfs)
- K = hydraulic conductivity (fps)
- A = surface area perpendicular to the direction of flow (ft²)
- i = hydraulic gradient (ft/ft) for a constant head and constant media depth, computed as follows:

$$i = \frac{h+l}{l} \quad \text{(Equation 6-94)}$$

Where:

h	=	average depth of water above the filter (ft), defined for this design as $d/2$
d	=	maximum storage depth above the filter (ft)
l	=	thickness of sand media (ft)

Darcy's law underlies both the simple and the routing methods of design. The filtration rate V , or more correctly, $1/V$, is the direct input in the sand filter design. The relationship between the filtration rate V and hydraulic conductivity K is revealed by equating Darcy's law and the equation of continuity, $Q = VA$. Specifically:

$$Q = KiA \quad \text{and} \quad Q = VA$$

$$\text{So,} \quad VA = KiA$$

$$\text{Or:} \quad V = Ki \quad \text{(Equation 6-95)}$$

Where,

$$V = \text{filtration rate (ft/s)}$$

Note that $V \neq K$. That is, the filtration rate is not the same as the hydraulic conductivity, but they do have the same units (distance per time). K can be equated to V by dividing V by the hydraulic gradient i , which is defined above.

The hydraulic conductivity K does not change with head nor is it dependent on the thickness of the media, only on the characteristics of the media and the fluid. A design hydraulic conductivity of 1 inch per hour (2 feet per day) used in this simple sizing method is based on bench-scale tests of conditioned rather than clean sand (KCSWDM, 2005) and represents the average sand bed condition as silt is captured and held in the sand bed.

Unlike the hydraulic conductivity, the filtration rate V changes with head and media thickness, although the media thickness is constant in the sand filter design.

Simple Sizing Method

The simple sizing method does not route flows through the filter. It determines the size of the filter based on the simple assumption that inflow is immediately discharged through the filter as if there were no storage volume. An adjustment factor (0.7) is applied to compensate for the greater filter size resulting from this method. Even with

the adjustment factor, the simple method generally produces a larger filter size than the routing method.

Step 1: Determine the water quality design volume

Sand filters should be sized to capture and treat the stormwater quality design volume (see [Section E.1](#)).

Step 2: Determine maximum storage depth of water

Determine the maximum water storage depth (d) above the sand filter. This depth is defined as the depth at which water begins to overflow the reservoir pond, and it depends on the site topography and hydraulic constraints. The depth is chosen by the designer, but shall be 6 feet or less.

Step 3: Calculate the sand filter area

Determine the sand filter area using the following equation:

$$A_{sf} = \frac{V_{wq}RL}{Kt(h+L)} \quad \text{(Equation 6-96)}$$

Where,

A_{sf}	=	surface area of the sand filter bed (ft ²)
V_{wq}	=	water quality design volume (ft ³)
R	=	routing adjustment factor (use $R = 0.7$)
L	=	sand bed depth (ft)
K_{des}	=	design hydraulic conductivity of media (use 2 ft/day)
t	=	drawdown time (use 1 day)
h	=	average depth of water above the filter (ft), [use ($d/2$) with d from Step 2]

Routing Method

A continuous runoff model, such as US EPA's Stormwater Management Model (SWMM) Model, can be used to optimally size a sand filter. A continuous simulation model consists of three components: a representative long term period of rainfall data (≈ 20 years or greater) as the primary model input; a model component representing the tributary area to the sand filter that takes into account the amount of impervious area, soil types of the pervious area, vegetation, evapotranspiration, etc.; and a component that simulates the sand filter. Using this method, the filter should be sized to capture and treat the WQ design volume from the post-development tributary area.

The continuous simulation model routes predicted tributary runoff to the sand filter, where treatment is simulated as a function of the infiltrative (flow) capacity of the sand filter and the available storage volume above the sand filter. In a continuous runoff model such as SWMM, the physical parameters of the sand filter are represented with stage-storage-discharge relationships. Due to the computational power of ordinary desktop computers, long-term continuous simulations generally take only minutes to run. This allows the modeler to run several simulations for a range of sand filter sizes, varying either the surface area of the filter (and resulting flow capacity) or the storage capacity above the sand filter, or both. Sufficient continuous model simulations should be completed so that results encompass the WQ design volume capture goal.

Model results should be plotted for both varying storage depths above the filter and for varying filter surface area (and resulting flow capacity) while keeping all other parameters constant. The resulting relationship of percent capture as a function of sand filter flow and storage capacity can be used to optimally size a sand filter based on site conditions and restraints.

In addition to continuous simulation modeling, routing spreadsheets and/or other forms of routing modeling that incorporate rainfall-runoff relationships and infiltrative (flow) capacities of sand filters may be used to size facilities. Alternative sizing methodologies should be prepared with good engineering practices.

Sizing and Geometry

- 1) Sand filters shall be sized to capture and filter the Stormwater quality design volume, SQDV (See Section 2 and Appendix E for further detail).
- 2) Sand filters may be designed in any geometric configuration, but rectangular with a 2:1 length-to-width ratio or greater is preferred.
- 3) Filter bed depth must be at least 24 inches, but 36 inches is preferred.
- 4) Depth of water storage over the filter bed should be 6 feet maximum. Minimum freeboard is one foot.
- 5) Sand filters should be placed off-line to prevent scouring of the filter bed by high flows. The overflow structure must be designed to pass the stormwater quality design storm.

Sand Specification

Ideally the effective diameter of the sand, d_{10} (the diameter corresponding to the sieve size that passes 10% of sand grains), should be just small enough to ensure a good quality effluent while preventing penetration of stormwater particles to such a depth that they cannot be removed by surface scraping (~2-3 inches). This effective diameter usually lies in the range 0.20-0.35 mm. In addition, the coefficient of uniformity, $C_u = d_{60}/d_{10}$, should be less than 3.

The sand in a filter should consist of medium sand with few fines meeting ASTM C 33 size gradation (by weight) or equivalent as given in the table below.

U.S. Sieve Size	Percent Passing
3/8 inch	100
U.S. No. 4	95 to 100
U.S. No. 8	80 to 100
U.S. No. 16	50 to 85
U.S. No. 30	25 to 60
U.S. No. 50	5 to 30
U.S. No. 100	Less than 10

Finally, the silica (SiO_2) content of the sand should be greater than 95% by weight.

Underdrain

- 1) There are several underdrain system options which can be used in the design of a sand filter:
 - a. A central underdrain collection pipe with lateral collection pipes in an 8 inch minimum gravel backfill or drain rock bed.
 - b. Longitudinal pipes in an 8 inch minimum gravel backfill or drain rock bed, with a collection pipe at the outfall.
 - c. Small sand filters may use a single underdrain pipe in an 8 inch minimum gravel backfill or drain rock bed.
- 2) All underdrain pipes and connectors must be 6 inches or greater so they can be cleaned without damage to the pipe. Clean-out risers with diameters equal to the underdrain pipe must be placed at the terminal ends of all pipes and extend to the surface of the filter. A valve box should be provided for access to the cleanouts and the cleanout assembly must be water tight to prevent short circuiting of the sand filter.
- 3) The underdrain pipe must be sized and perforated as to ensure free draining of the sand filter bed. Round perforations must be at least 1/2-inch in diameter and the pipe must be laid with holes downward.
- 4) The maximum perpendicular distance between any two lateral collection pipes or from the edge of the filter and the collection pipes shall be 9 feet.
- 5) All pipes must be placed with a minimum slope of 0.5%.
- 6) The invert of the underdrain outlet must be above the seasonal high groundwater level.

- 7) At least 8 inches of gravel backfill must be maintained over all underdrain piping, and at least 6 inches must be maintained on both side and beneath the pipe to prevent damage by heavy equipment during maintenance. Either drain rock or gravel backfill may be used between pipes.
- 8) The bottom gravel layer should have a diameter at least 2X the size of the openings into the drainage system. The grains should be hard, preferably rounded, with a specific gravity of at least 2.5, and free of clay, debris and organic impurities.
- 9) Either a geotextile fabric or a two-inch transition gradation layer (preferred) must be placed between the sand layer and the drain rock or gravel backfill layer. If a geotextile is used, one inch of drain rock or gravel backfill should be placed above the fabric. This allows for a transitional zone between sand and gravel and may reduce pooling of water at the liner interface. The geotextile must meet the following minimum materials requirements.

Geotextile Property	Value	Test Method
Trapezoidal Tear (lbs)	40 (min)	ASTM D4533
Permeability (cm/sec)	0.2 (min)	ASTM D4491
AOS (sieve size)	#60 - #70 (min)	ASTM D4751
Ultraviolet resistance	70% or greater	ASTM D4355

Flow Spreader

- 1) A flow spreader shall be installed at the inlet along one side of the filter to evenly distribute incoming runoff across the filter and to prevent erosion of the filter surface.
 - a. If the sand filter is curved or an irregular shape, a flow spreader shall be provided for a minimum of 20 percent of the filter perimeter.
 - b. If the length-to-width ratio of the filter is 2:1 or greater, a flow spreader must be located on the longer side and for a minimum length of 20 percent of the facility perimeter.
 - c. In other situations, use good engineering judgment in positioning the spreader.
- 2) Erosion protection shall be provided along the first foot of the sand bed adjacent to the flow spreader. Geotextile weighted with sand bags at 15-foot intervals may be used. Quarry spalls may also be used.

Vegetation

- 1) The use of vegetation in sand filters is optional. However, no top soil should be added to the sand filter bed because the fine-grained materials (silt and clay) would reduce the hydraulic capacity of the filter.
- 2) Growing grass or other vegetation requires the selection of species that can tolerate the demanding environment of a sand filter bed. Plants not receiving sufficient dry weather flows must be able to withstand long periods of drought during summer periods, followed by periods of saturation during storm events. A horticultural specialist should be consulted for advice on species selection.
- 3) A sod grown in sand may be used on the sand surface as long as there is no clay in the sand substrate and the particle size gradation of the substrate meets the sand filter specifications. No other sod shall be used due to the high clay content in most sod soils.
- 4) To prevent uses that could compact and damage the filter surface, permanent structures are not permitted on sand filters (e.g. playground equipment).

Emergency Overflow Structure

Sand filters may only be placed off-line, but an emergency overflow must still be provided in the event the filter becomes clogged. The overflow structure must be able to safely convey flows from the stormwater quality design storm to the downstream conveyance system or other acceptable discharge point.

Side Slopes

- 1) Interior side slopes up to the emergency overflow water surface shall be no steeper than 3H:1V, unless stabilization has been approved by a licensed geotechnical engineer.
- 2) Exterior side slopes shall be no steeper than 2H:1V, unless stabilization has been approved by a licensed geotechnical engineer.
- 3) For any slope (interior or exterior) greater than 2H:1V a geotechnical report must be submitted and approved by the County's Geotechnical and Materials Engineering Division.
- 4) Pond walls may be vertical retaining walls, provided: (a) they are constructed of reinforced concrete, (b) a fence, which prevents access, is provided along the top of the wall or further back, and (c) the design is stamped by a licensed civil engineer and approved by the County.

Embankments

- 1) Embankments (earthen slopes or berms) may be used for detaining or redirecting the flow of water.
- 2) The minimum top width of all berm embankments shall be 20 feet, or as approved by the geotechnical engineer.
- 3) Basin berm embankments must be constructed on native consolidated soil (or adequately compacted and stable fill soils analyzed by a licensed geotechnical engineer) free of loose surface soil materials, roots, and other organic debris.
- 4) Earthworks shall be in accordance with Section 300-6 of the Standard Specifications for Public Works Construction, most recent edition.
- 5) Basin berm embankments greater than 4 feet in height must be constructed by excavating a key equal to 50% of the berm embankment cross-sectional height and width. This requirement may be waived if specifically recommended by a licensed geotechnical engineer.
- 6) The berm embankment shall be constructed of compacted soil (95% minimum dry density, modified proctor method per ASTM D1557), placed in 6-inch lifts.

Maintenance Access

Maintenance access road(s) shall be provided to the control structure and other drainage structures associated with the basin (e.g., inlet, emergency overflow or bypass structures). Manhole and catch basin lids must be in or at the edge of the access road.

An access ramp is required for removal of sediment with a backhoe or loader and truck. The ramp must extend to the bottom of the sand filter.

Access roads shall meet the following design criteria:

- 1) All access ramps and roads shall be paved with a minimum of 3 inches concrete over 4 inches of crushed aggregate base material. This requirement may be modified depending on the soil conditions and intended use of the road at the discretion of the design engineer.
- 2) Maximum grade shall be 12% unless otherwise approved by LAUSD.
- 3) Centerline turning radius shall be 40 feet, minimum.
- 4) Access roads less than 500 ft long shall have 12 feet wide pavement within a minimum 15 feet wide bench. Access roads greater than 500 feet long shall have 16 feet wide pavement within a minimum 20 feet wide bench.

- 5) All access roads shall terminate with turnaround areas of 40 feet by 40 feet. A hammer type turn around area or a circle drive around the top of the facility is also acceptable.
- 6) Adequate gates and commercial driveways are required at street crossings. Gates should be located a minimum of 25 feet from the street curb except in residential areas where the gates may be located along the property line provided there is adequate site distance to see oncoming vehicles at the posted speed limit.

Landscaping Outside of the Facility

A sand filter can add aesthetics to a site and should be incorporated into a project's landscape design. Interior side slopes may be stepped with flat areas to provide informal seating with a game or play area below. Perennial beds may be planted above the overflow water surface elevation. Large shrubs and trees are not recommended, however, as shading limits evaporation and falling leaves can clog the filter surface. If a sand filter area is intended for recreational uses, such as a volleyball area, the interior side slopes of the filter embankment should be no steeper than 3:1 and may be stepped.

- 1) No trees or shrubs may be planted within 10 feet of inlet or outlet pipes or manmade drainage structures such as spillways, flow spreaders, or earthen embankments. Species with roots that seek water, such as willow or poplar, shall not be used within 50 feet of pipes or manmade structures.
- 2) Prohibited non-native plant species will not be permitted. For more information on invasive weeds, including biology and control of listed weeds, look at the "encycloweedia" located at the California Department of Food and Agriculture website at <http://www.cdfa.ca.gov/wma> or the California Invasive Plant Council website at <http://portal.cal-ipc.org/weedlist>.

Operations and Maintenance

Sand filters are subject to clogging by fine sediment, oil and grease, and other debris (e.g., trash and organic matter such as leaves). Filters and pretreatment facilities should be inspected every 6 months during the first year of operation. Inspection should also occur immediately following a storm event to assess the filtration capacity of the filter. Once the filter is performing as designed, the frequency of inspection may be reduced to once per year.

Most of the maintenance should be concentrated on the pretreatment practices, such as buffer strips and swales upstream of the trench to ensure that sediment does not reach the infiltration trench. Regular inspection should determine if the sediment removal structures require preventative maintenance.

Inspect basin a minimum of twice a year, before and after the rainy season, after large storm events, or more frequently if needed. Some important items to check for include: differential settlement, cracking; erosion, leakage, or tree growth on the embankment;

the condition of the riprap in the inlet, outlet and pilot channels; sediment accumulation in the basin; and the vigor and density of the vegetation on the basin side slopes and floor. Correct observed problems as necessary.

- Remove litter and debris from banks and basin bottom as required.
- Repair erosion to banks and bottom as required.
- Check infiltration rate of sand bed twice annually, once after significant rainfall.
- Scarify top 3 to 5 inches of filters surface by raking once annually or as required to restore infiltration rate of the filter.
- Clean forebay every two years at a minimum, to avoid accumulation in main basin.
- Inspect outlet for clogging a minimum of twice a year, before and after the rainy season, after large storms, and more frequently if needed. Correct observed problems as necessary.

TCM-5: Cartridge Media Filter

Cartridge media filters are manufactured devices that typically consist of a series of cylindrical vertical filters contained in a catch basin, manhole, or vault that provide treatment through filtration and sedimentation. The manhole or vault may be divided into multiple chambers where the first chamber acts as a pre-settling basin for removal of coarse sediment while another chamber acts as the filter bay and houses the filter cartridges.



Cartridge Media Filters

Photo Credits: Contech Stormwater Solutions, Inc.

Application

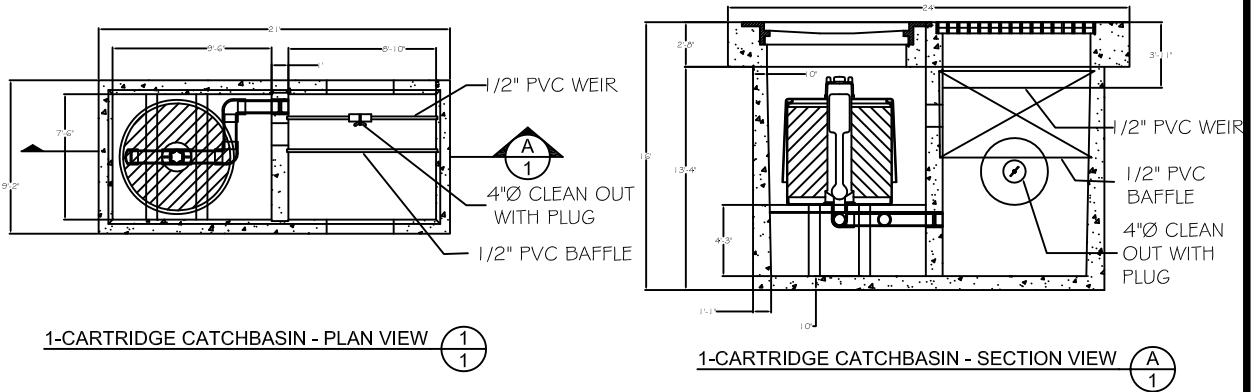
- Parking lots
- Roadways
- Playgrounds
- Outdoor eating areas

Preventative Maintenance

- Filter media replacement
- Solids removal from vault, manhole, or catch basin
- Inspect for inlet and outlet for clogging



STORMFILTER



KriStar Enterprises, Inc.

380 Sutton Place, Santa Rosa, CA 95407
 Ph: 800.579.8819, Fax: 707.524.8186, www.kristar.com

Up-Flo™ Filter
 8' X 13' VAULT CONFIGURATION
 14 MODULE MAXIMUM

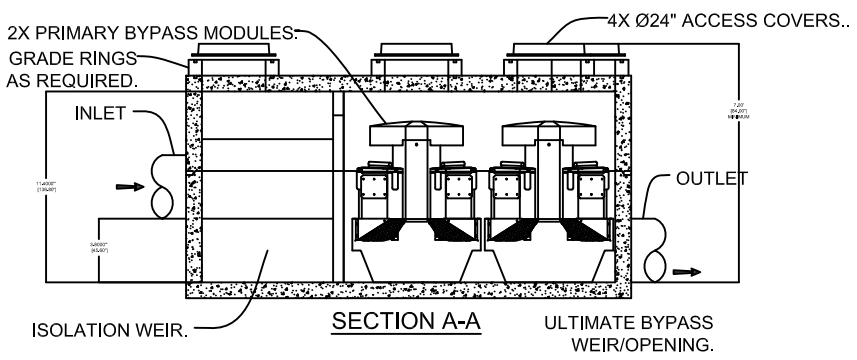
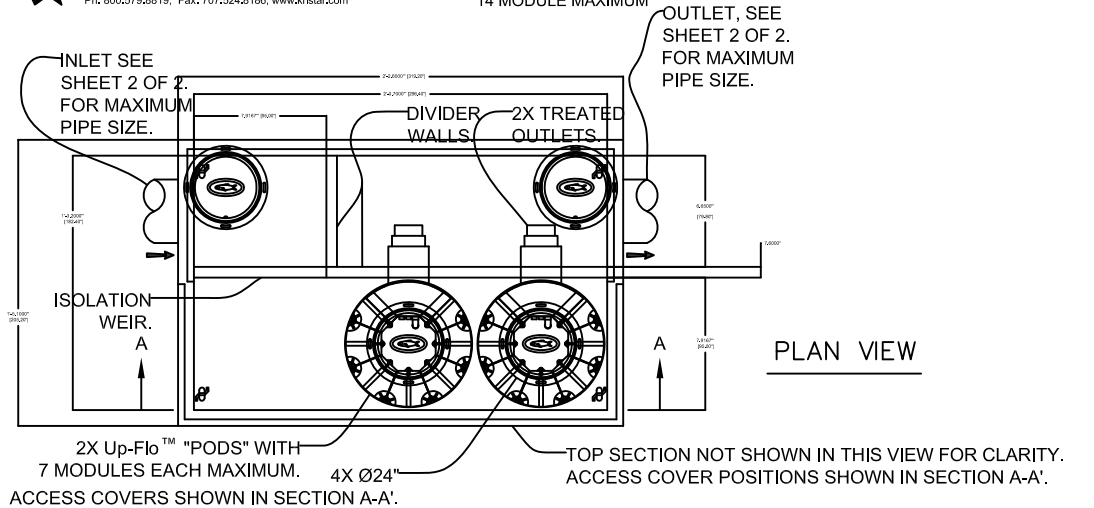


Figure 6-23: Cartridge Media Filter

Table 6-26: Proprietary Cartridge Media Filter Manufacturer Websites

Device	Manufacturer	Website
BaySaver BayFilter	Baysaver Technologies Inc.	www.baysaver.com
ConTech StormFilter™	Contech® Construction Products Inc.	www.contech-cpi.com
CrystalStream	CrystalStream Technologies	www.crystalstream.com
KriStar Fossil Tee™ (media filter)	KriStar Enterprises Inc.	www.kristar.com
KriStar Up-Flo™ Filter and Perk™ Filter	KriStar Enterprises Inc.	www.kristar.com

Limitations

As with all filtration systems, use in catchments that have significant areas of non-stabilized soils can lead to premature clogging.

Design Criteria

- 1) Cartridge media filter BMP vendors are constantly updating and expanding their product lines, so refer to the latest design guidance from each of the vendors.
- 2) Selected filter media should target pollutants of concern. A combination of media is often recommended to maximize pollutant removal. Perlite is effective for removing TSS and oil and grease. Zeolite removes soluble metals, ammonium, and some organics. Vendors also offer proprietary medias (such as leaf compost or activated carbon) that are designed to remove soluble metals, organics, and other pollutants.
- 3) Manufacturers try to distinguish their products through innovative designs that aim at providing self cleaning and draining, uniformly loaded, and clog resistant cartridges that functional properly over a wide range of hydraulic loadings and pollutant concentrations.
- 4) All stormwater vaults containing cartridge filters that have standing water for longer than 72 hours can become a breeding area for mosquitoes. The selected BMP should have a system to completely drain the vault, such as weep holes in the bottom of the vault.

Sizing

- 1) Cartridge media filters should be sized to capture and treat the stormwater quality design flow rate.
- 2) Proprietary cartridge media filter devices, like most proprietary BMPs, and auxiliary components such as media, screens, baffles, and sumps are selected based onsite-specific conditions such as the loading that is expected and the desired frequency of maintenance. Sizing of proprietary devices is reduced to a simple process whereby a model can simply be selected from a table or a chart based on a few known quantities

(tributary area, location, design flow rate, etc). Most of the manufacturers either size the devices for potential clients or offer calculators on their websites that simplify the design process. For the latest sizing guidelines, refer to the manufacturer's website.

PT-1: Hydrodynamic Separation Device

Hydrodynamic separation devices (alternatively, swirl concentrators) are devices that remove trash, debris, and coarse sediment from incoming flows using screening, gravity settling, and centrifugal forces generated by forcing the influent into a circular motion. By having the water move in a circular fashion, rather than a straight line, it is possible to obtain significant removal of suspended sediments and attached pollutants with less space as compared to wet vaults and other settling devices. Hydrodynamic devices were originally developed for combined sewer overflows (CSOs), where they were used primarily to remove coarse inorganic solids. Hydrodynamic separation has been adapted for stormwater treatment by several manufacturers and is currently used to remove trash, debris, and other coarse solids down to sand-sized particles. Several types of hydrodynamic separation devices are also designed to remove floating oils and grease using sorbent media.



Hydrodynamic Separation

*Photo Credits: 1. Contech Stormwater Solutions, Inc.;
2. Dave Weller, FedCo Construction*

Application

- Parking lots
- Areas adjacent to parking lots
- Areas adjacent to buildings
- Road medians and shoulders

Preventative Maintenance

- Sediment, trash and debris removal
- Vector control

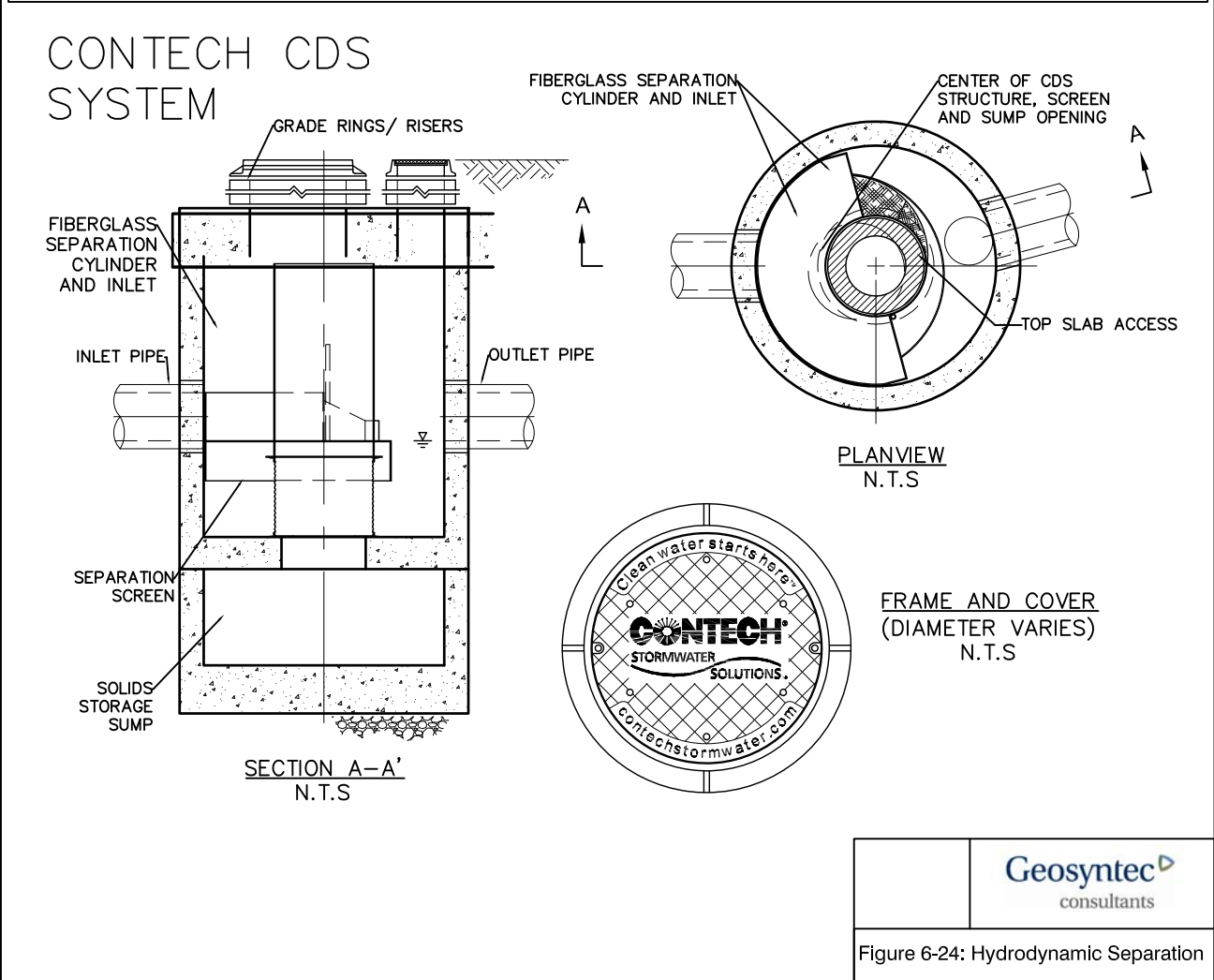
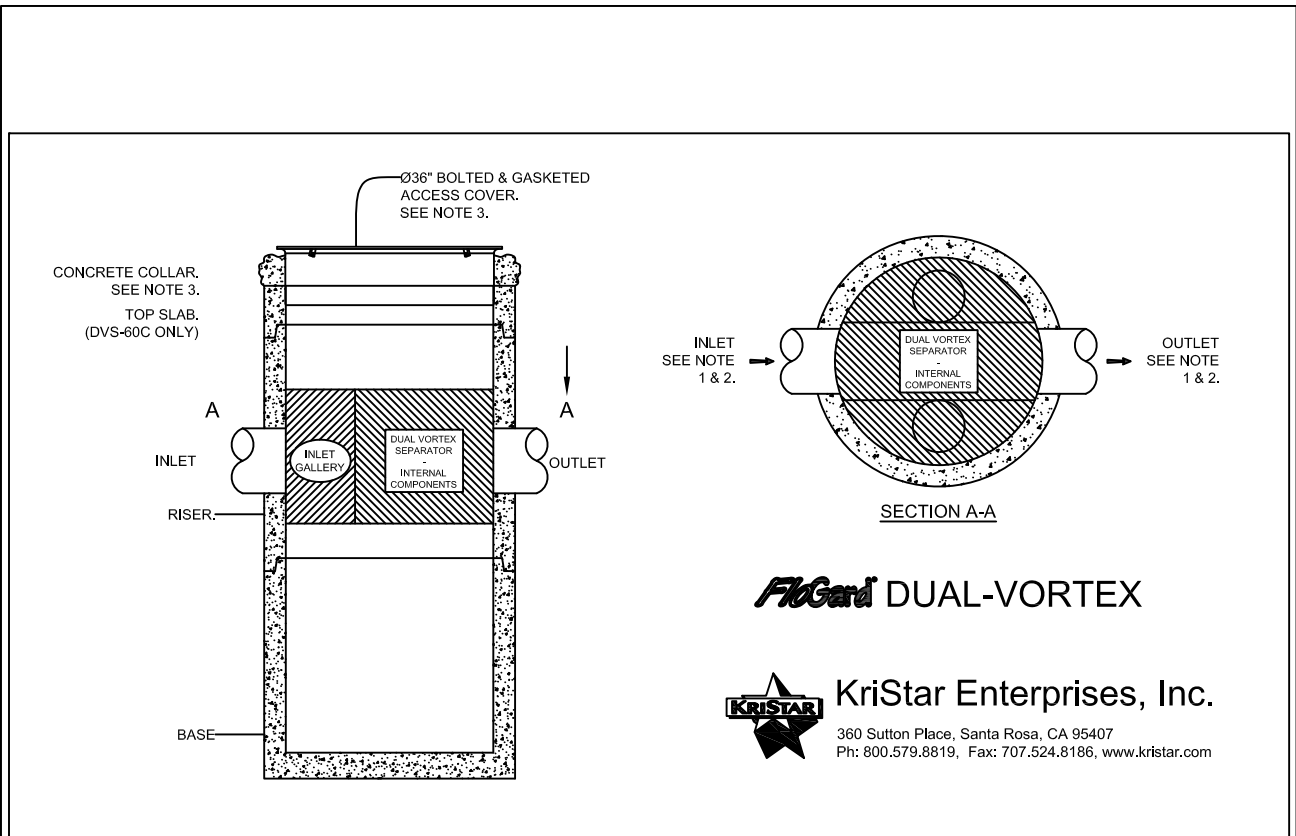


Table 6-27: Proprietary Hydrodynamic Device Manufacturer Websites

Device	Manufacturer	Website
Rinker In-Line Stormceptor®	Rinker Materials™	www.rinkerstormceptor.com
FloGard® Dual-Vortex Hydrodynamic Separator	KriStar Enterprises Inc.	www.kristar.com
Contech® CDS ^a ™	Contech® Construction Products Inc.	www.contech-cpi.com
Contech® Vortechs™	Contech® Construction Products Inc.	www.contech-cpi.com
Contech® Vorsentry™	Contech® Construction Products Inc.	www.contech-cpi.com
Contech® Vorsentry™ HS	Contech® Construction Products Inc.	www.contech-cpi.com
BaySaver BaySeparator	Baysaver Technologies Inc.	www.baysaver.com

Limitations

Hydrodynamic separation devices are effective for the removal of coarse sediment, trash, and debris, and are useful as pretreatment in combination with other BMP types that target smaller particle sizes.

Hydrodynamic devices represent a wide range of device types that have different unit processes and design elements (e.g., storage versus flow-through designs, inclusion of media filtration, etc.) that vary significantly within the category. These design features likely have significant effects on BMP performance; therefore, generalized performance data for hydrodynamic devices is not practical.

Design Criteria

Proprietary hydrodynamic device BMP vendors are constantly updating and expanding their product lines, so refer to the latest design guidance from each of the vendors. General guidelines on the performance, sizing, operations and maintenance of proprietary devices are provided by the vendors.

Sizing

Hydrodynamic devices shall be sized to capture and treat the stormwater quality design flow rate and to completely drain within 72 hours.

Sizing of proprietary devices is reduced to a simple process whereby a model can simply be selected from a table or a chart based on a few known quantities (tributary area, location, design flow rate, design volume, etc). A few of the manufacturers either size the devices for potential clients or offer calculators on their websites that simplify the design process even further and lessens the possibility of using obsolete design information. For the latest sizing guidelines, refer to the manufacturer's website.

Operations and Maintenance

Hydrodynamic devices are subject to clogging by fine sediment, oil and grease, and other debris (e.g., trash and organic matter such as leaves). Device should be inspected every 6 months during the first year of operation. Inspection should also occur immediately following a storm event to assess the function of the device. Once the device is performing as designed, the frequency of inspection may be reduced to once per year.

PT-2: Catch Basin Insert

Catch basin inserts are manufactured filters or fabric placed in a drop inlet to remove sediment and debris and may include sorbent media (oil absorbent pouches) to remove floating oils and grease. Catch basin inserts are selected specifically based upon the orientation of the inlet.



Application

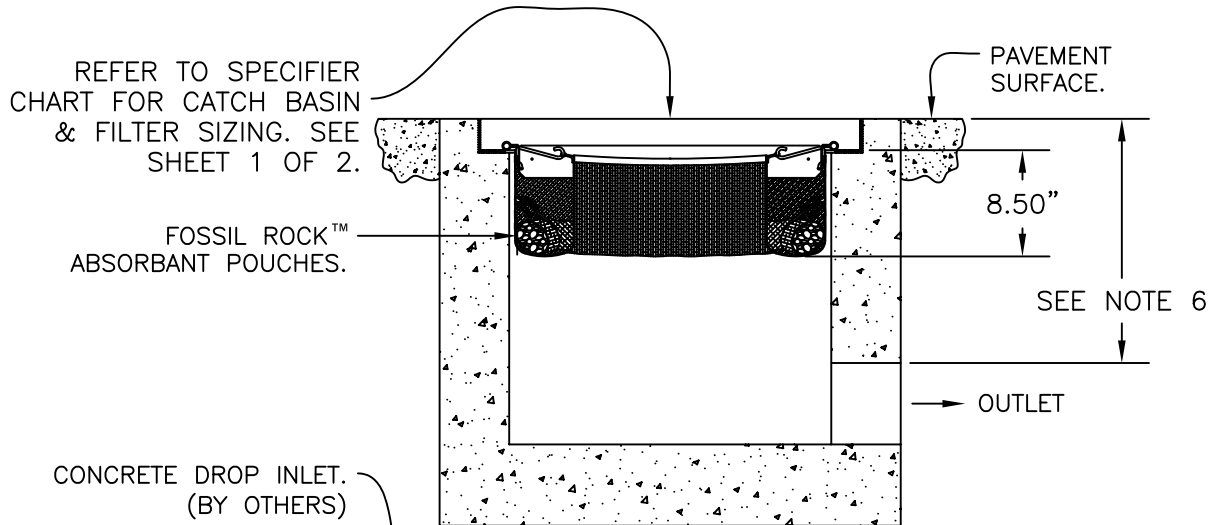
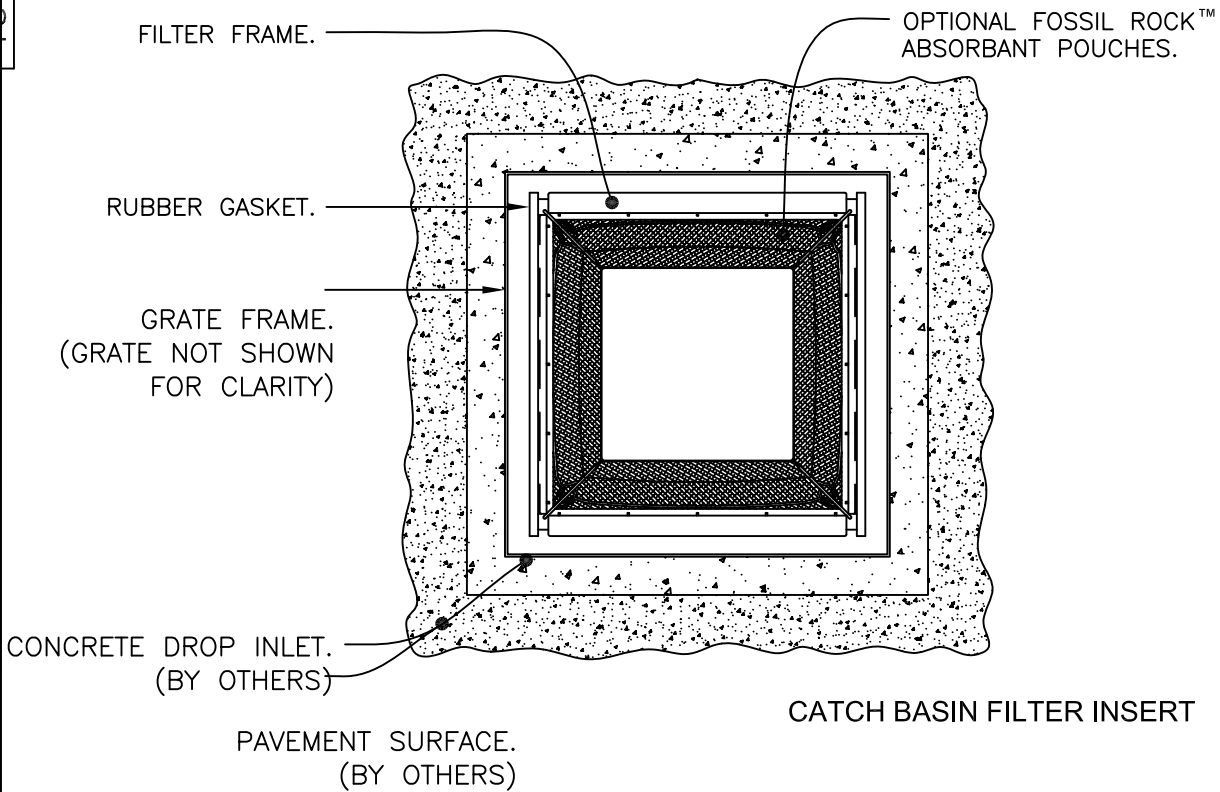
- Parking lots
- Roads
- Athletic courts
- Outdoor food areas

Preventative Maintenance

- After storm inspection
- Sediment removal
- Trash removal
- Filter/sorbent media replacement

Catch Basin Inserts

Photo Credits: 1. KriStar; 2. Aquashield



KriStar Enterprises, Inc.

360 Sutton Place, Santa Rosa, CA 95407
Ph: 800.579.8819, Fax: 707.524.8186, www.kristar.com

FloGard

Geosyntec
consultants

Figure 6-25: Catch Basin

Table 6-28: Proprietary Catch Basin Insert Manufacturer Websites

Device	Manufacturer	Website
AbTech Industries Ultra-Urban Filter™	AbTech Industries	www.abtechindustries.com
Aquashield Aqua-Guardian™ Catch Basin Insert	Aquashield™ Inc.	www.aquashieldinc.com
Bowhead StreamGuard™	Aquashield™ Inc.	www.aquashieldinc.com
Contech® Triton Catch Basin Filter™	Contech® Construction Products Inc.	www.contech-cpi.com
Contech® Triton Curb Inlet Filter™	Contech® Construction Products Inc.	www.contech-cpi.com
Contech® Triton Basin StormFilter™	Contech® Construction Products Inc.	www.contech-cpi.com
Contech® Curb Inlet StormFilter™	Contech® Construction Products Inc.	www.contech-cpi.com
Curb Inlet Basket	SunTree Technologies Inc.	www.suntreetech.com
Curb Inlet Grates	EcoSense International™	www.ecosenseinternational.org
Grate Inlet Skimmer Box	SunTree Technologies Inc.	www.suntreetech.com
Hydro-Kleen™ Filtration System	Hydro Compliance Management Inc.	Not available
KriStar FloGard+PLUS®	KriStar Enterprises Inc.	www.kristar.com
KriStar FloGard®	KriStar Enterprises Inc.	www.kristar.com
KriStar FloGard LoPro Matrix Filter®	KriStar Enterprises Inc.	www.kristar.com
Nyloplast Storm-PURE Catch Basin Insert	Nyloplast Engineered Surface Drainage Products	www.nyloplast-us.com
StormBasin®	FabCo® Industries Inc.	www.fabco-industries.com
Stormdrain Solutions Interceptor	FabCo® Industries Inc.	www.fabco-industries.com
Stormdrain Solutions Inceptor®	Stormdrain Solutions	www.stormdrains.com
StormPod®	FabCo® Industries Inc.	www.fabco-industries.com
Stormwater Filtration Systems	EcoSense International™	www.ecosenseinternational.org
Ultra-CurbGuard®	UltraTech International Inc.	www.spillcontainment.com
Ultra-DrainGuard®	UltraTech International Inc.	www.spillcontainment.com
Ultra-GrateGuard®	UltraTech International Inc.	www.spillcontainment.com
Ultra-GutterGuard®	UltraTech International Inc.	www.spillcontainment.com
Ultra-InletGuard®	UltraTech International Inc.	www.spillcontainment.com

Limitations

Catch basin inserts come in such a wide range of configurations that it is practically impossible to generalize the expected performance. Inserts shall mainly be used for catching coarse sediments and floatable trash, and are effective as pretreatment in combination with other types of structures that are recognized as water quality treatment BMPs. Trash and large objects can greatly reduce the effectiveness of catch basin inserts with respect to sediment and hydrocarbon capture. Frequent

maintenance and the use of screens and grates to keep trash out may decrease the likelihood of clogging and prevent obstruction and bypass of incoming flows.

Design Criteria

Catch basin inserts shall be sized to capture and treat the stormwater quality design flow rate.

Operations and Maintenance

- 1) Trash, debris, and sediment around insert grate and inside chamber requiring trash to be cleared
- 2) Repair filter media if damaged or severely clogged.

7 MAINTENANCE PLAN

This chapter identifies the basic information that shall be included in a maintenance plan. Refer to Fact Sheets for individual control measures in Chapter 6 regarding device-specific maintenance requirements.

7.1 Site Map

- 1) Provide a site map showing boundaries of the site, acreage and drainage patterns/contour lines. Show each discharge location from the site and any drainage flowing onto the site. Distinguish between soft and hard surfaces on the map.
- 2) Identify locations of existing and proposed storm drain facilities, private sanitary sewer systems and grade-breaks for purposes of pollution prevention.
- 3) With legend, show locations of expected sources of pollution generation (outdoor work and storage areas, heavy traffic areas, delivery areas, trash enclosures, fueling areas, industrial clarifiers, wash-racks, etc). Identify any areas having contaminated soil or where toxins are stored or have been stored/disposed of in the past.
- 4) With legend, indicate types and locations of stormwater management control measures which will be built to permanently control stormwater pollution. Distinguish between pollution prevention, treatment, sewer diversion, and containment devices.

7.2 Baseline Descriptions

- 1) List the property owners and persons responsible for operation and maintenance of the stormwater management control measures onsite. Include phone numbers and addresses.
- 2) Identify the intended method of providing financing for operation, inspection, routine maintenance and upkeep of stormwater control measures.
- 3) List all permanent stormwater control measures. Provide a brief description of stormwater management control measures selected and if appropriate, facts sheets or additional information.
- 4) As appropriate for each stormwater control measure provide:
 - a. A written description and check list of all maintenance and waste disposal activities that will be performed. Distinguish between the maintenance appropriate for a 2-year establishment period and expected long-term maintenance. For example, maintenance requirements for vegetation in a constructed wetland may be more intensive during the first few years until the vegetation is established. The post-establishment maintenance

plan shall address maintenance needs (e.g., pruning, irrigation, weeding) for a larger, more stable system. Include maintenance performance procedures for facility components that require relatively unique maintenance knowledge, such as specific plant removal / replacement, landscape features, or constructed wetland maintenance. These procedures shall provide enough detail for a person unfamiliar with maintenance to perform the activity, or identify the specific skills or knowledge necessary to perform and document the maintenance.

- b. A description of site inspection procedures and documentation system, including record-keeping and retention requirements.
 - c. An inspection and maintenance schedule, preferably in the form of a table or matrix, for each activity for all facility components. The schedule shall demonstrate how it will satisfy the specified level of performance, and how the maintenance / inspection activities relate to storm events and seasonal issues.
 - d. Identification of the equipment and materials required to perform the maintenance.
- 5) As appropriate, list all housekeeping procedures for prohibiting illicit discharges or potential illicit discharges to the storm drain. Identify housekeeping BMPs that reduce maintenance of Treatment Control Measures. These procedures are listed based on facility operations and can be found in the Ventura County Industrial/Commercial Clean Business Program document.

7.3 Spill Plan

- 1) Provide emergency notification procedures (phone and agency/persons to contact)
- 2) As appropriate for site, provide emergency containment and cleaning procedures.
- 3) Note downstream receiving water bodies or wetlands which may be affected by spills or chronic untreated discharges.
- 4) As appropriate, create an emergency sampling procedure for spills. (Emergency sampling can protect the property owner from erroneous liability for downstream receiving area clean-ups).

7.4 Facility Changes

Operational or facility changes which significantly affect the character or quantity of pollutants discharging into the stormwater management control measures will require modifications to the Maintenance Plan and/or additional stormwater control measures.

7.5 Training

- 1) Identify appropriate persons to be trained and assure proper training.
- 2) Training to include:
 - a. Good housekeeping procedures defined in the plan.
 - b. Proper maintenance of all pollution mitigation devices.
 - c. Identification and cleanup procedures for spills and overflows.
 - d. Large-scale spill or hazardous material response.
 - e. Safety concerns when maintaining devices and cleaning spills.

7.6 Basic Inspection and Maintenance Activities

- 1) Create and maintain onsite, a log for inspector names, dates and stormwater control measure devices to be inspected and maintained. Provide a checklist for each inspection and maintenance category.
- 2) Once annually, perform testing of any mechanical or electrical devices prior to wet weather.
- 3) Report any significant changes in stormwater management control measures to the site management. As appropriate, assure mechanical devices are working properly and/or landscaped BMP plantings are irrigated and nurtured to promote thick growth.
- 4) Note any significant maintenance requirements due to spills or unexpected discharges.
- 5) As appropriate, perform maintenance and replacement as scheduled and as needed in a timely manner to assure stormwater management control measures are performing as designed and approved.
- 6) Assure unauthorized low-flow discharges from the property do not by-pass stormwater control measures.
- 7) Perform an annual assessment of each pollution generation operation and its associated stormwater management control measures to determine if any part of the pollution reduction train can be improved.

7.7 Revisions of Pollution Mitigation Measures

If future correction or modification of past stormwater management control measures or procedures is required, the owner shall obtain approval from the governing stormwater

agency prior to commencing any work. Corrective measures or modifications shall not cause discharges to bypass or otherwise impede existing stormwater control measures.

7.8 Monitoring & Reporting Program

- 1) The governing stormwater agency may require a Monitoring & Reporting Program to assure the stormwater management control measures approved for the site are performing according to design.
- 2) If required by local permitting agency, the Maintenance Plan shall include performance testing and reporting protocols.

APPENDIX A : ACRONYMS AND GLOSSARY OF TERMS

A.1 Acronyms and Abbreviations

303(d) 303(d) List of Impaired Water Bodies

API	American Petroleum Institute (oil/water separator type)
BMP	Best Management Practice
CEQA	California Environmental Quality Act
CP	Coalescing Plate (oil/water separator type)
CTR	California Toxics Rule
CWA	Clean Water Act
CDFG	California Department of Fish and Game
EIA	Effective Impervious Area
EMC	Event Mean Concentration
ESA	Environmentally Sensitive Area
LID	Low Impact Development
MEP	Maximum Extent Practicable
MS4	Municipal Separate Storm Sewer System
SQDV	Stormwater Quality Design Volume
SQDF	Stormwater Quality Design Flow
TSS	Total Suspended Solids
USACE	United States Army Corps of Engineers
USEPA	United States Environmental Protection Agency
WERF	Water Environment Research Foundation

A.2 Glossary

Automotive Repair Shop: A facility that is categorized in any one of the following Standard Industrial Classification (SIC) codes: 5013, 5014, 5541, 7532-7534, or 7536-7539.

Backfill: Earth or engineered material used to refill a trench or an excavation.

Berm: An earthen mound used to direct the flow of runoff around or through a structure.

Best Management Practice (BMP): Any program, technology, process, siting criteria, operational methods or measures, or engineered systems, which when implemented prevent, control, remove, or reduce pollution.

Best Management Practices (BMPs): Includes schedules of activities, prohibitions of practices, maintenance procedures, and other management practices to prevent or reduce the pollution of waters of the United States. BMPs also include treatment requirements, operating procedures, and practices to control plant site runoff, spillage or leaks, sludge or waste disposal, or drainage from raw material storage.

Bioretention Facility: A facility that utilizes soil infiltration and both woody and herbaceous plants to remove pollutants from stormwater runoff. Runoff is typically captured and infiltrated over a period of 24 to 48 hours.

Blue Roof: A roof that is designed to store rainwater, typically in a cistern-type device.

Brown Roof: A type of green roof which focuses on biodiversity and locally-sourced material.

Buffer Strip or Zone: Strip of erosion-resistant vegetation over which stormwater runoff is directed.

Capacity: The capacity of a stormwater drainage facility is the flow volume or rate that the facility (e.g., pipe, basin, vault, swale, ditch, drywell, etc.) is designed to safely contain, receive, convey, reduce pollutants from, or infiltrate stormwater to meet a specific performance standard. There are different performance standards for pollution reduction, flow control, conveyance, and destination/ disposal, depending on location.

Catch Basin: Box-like underground concrete structure with openings in curbs and gutters designed to collect runoff from streets and pavements.

Check Dam: Small temporary barrier, grade control structure, or dam constructed across a swale, drainage ditch, or area of concentrated flow with the intent to slow or stop runoff.

Clean Water Act (CWA): (33 U.S.C. 1251 et seq.) requirement of the National Pollutant Discharge Elimination System (NPDES) program are defined under Sections 307, 402, 318 and 405 of the CWA.

Commercial Development: Any development on private land that is not heavy industrial or residential. The category includes, but is not limited to: hospitals, laboratories and other medical facilities, educational institutions, recreational

facilities, plant nurseries, multi-apartment buildings, car wash facilities, mini-malls and other business complexes, shopping malls, hotels, office buildings, public warehouses and other light industrial complexes.

Conduit: Any channel or pipe for directing the flow of water.

Construction General Permit: A NPDES permit issued by the State Water Resources Control Board (SWRCB) for the discharge of stormwater associated with construction activity from soil disturbance of five (5) acres or more.

Control Device: A device used to hold back or direct a calculated amount of stormwater to or from a stormwater management facility. Typical control structures include vaults or manholes fitted with baffles, weirs, or orifices.

Conveyance System: Any channel or pipe for collecting and directing the Stormwater.

Culvert: A covered channel or a large diameter pipe that crosses under a road, sidewalk, etc.

Dead-end Sump: A below surface collection chamber for small drainage areas that is not connected to the public storm drainage system. Accumulated water in the chamber must be pumped and disposed in accordance with all applicable laws.

Designated Public Access Points: Any pedestrian, bicycle, equestrian, or vehicular point of access to jurisdictional channels in the area of Ventura County subject to permit requirements.

Detention: The temporary storage of stormwater runoff to allow treatment by sedimentation and metered discharge of runoff at reduced peak flow rates.

Detention Facility: A facility designed to receive and hold stormwater and release it at a slower rate, usually over a number of hours. The full volume of stormwater that enters the facility is eventually released.

Detention Tank, Vault, or Oversized Pipe: A structural subsurface facility used to provide flow control for a particular drainage basin.

Directly Adjacent: Situated within 200 feet of the contiguous zone required for the continued maintenance, function, and structural stability of the environmentally sensitive area.

Directly Connected Impervious Area (DCIA): The area covered by a building, impermeable pavement, and/ or other impervious surfaces, which drains directly into the storm drain without first flowing across permeable land area (e.g. turf buffers).

Directly Discharging: Outflow from a drainage conveyance system that is composed entirely or predominantly of flows from the subject, property,

development, subdivision, or industrial facility, and not commingled with the flows from adjacent lands.

Discharge: A release or flow of Stormwater or other substance from a conveyance system or storage container.

Disturbed Area: Any area that is altered as a result of land disturbance, such as: clearing, grading, grubbing, stockpiling and excavation.

Drainage Basin: A specific area that contributes stormwater runoff to a particular point of interest, such as a stormwater management facility, drainageway, wetland, river, or pipe.

Effective Impervious Area (EIA): That portion of the surface area that is hydrologically connected via sheet flow over a hardened conveyance or impervious surface without any intervening medium to mitigate flow volume.

Environmentally Sensitive Area (ESA): An area “in which plant or animal life or their habitats are either rare or especially valuable because of their special nature or role in an ecosystem and which would be easily disturbed or degraded by human activities and developments” (California Public Resources Code § 30107.5). Areas subject to stormwater mitigation requirements are: 303(d) listed water bodies in all reaches that are unimproved and soft-bottomed and all California Coastal Commission’s *Environmentally Sensitive Habitat Areas* as delineated on maps in Local Coastal Plans. The California Department of Fish and Game’s (CDFG) *Significant Natural Areas* map will be considered for inclusion as the department field-verifies the designated locations.

Erosion: The wearing a way of land surface by wind or water. Erosion occurs naturally from weather or runoff, but can be intensified by land-clearing practices relating to farming; residential, commercial, or industrial development; road building; or timber cutting.

Excavation: The process of removing earth, stone, or other materials, usually by digging.

Extended Detention Basin: A surface vegetated basin used to provide flow control for a particular drainage basin. Stormwater temporarily fills the extended detention basin during large storm events and is slowly released over a number of hours, reducing peak flow rates.

Facility: Is a collection of industrial process discharging stormwater associated with industrial activity within the property boundary or operational unit.

Filter Fabric: Geotextile of relatively small mesh or pore size that is used to: (a) allow water to pass through while keeping sediment out (permeable); or (b) prevent both runoff and sediment from passing through (impermeable).

Filter Strip: A gently sloping, densely grassed area used to filter, slow, and infiltrate stormwater.

Flow Control Facility: Any structure or drainage device that is designed, constructed, and maintained to collect, retain, infiltrate, or detain surface water runoff during and after a storm event for the purpose of controlling post-development quantity leaving the site.

Flow Control: The practice of limiting the release of peak flow rates, flow durations, and volumes from a site. Flow control is intended to protect downstream properties, infrastructure, and natural resources from the increased stormwater runoff flow rates and volumes resulting from development.

Grading: The cutting and/or filling of the land surface to a desired shape or elevation.

Green Roof: A roofing system that layers a soil/vegetative cover over a waterproofing membrane. Green roofs rely on highly porous media and moisture retention layers to store intercepted precipitation and to support vegetation that can reduce the volume of stormwater runoff via evapotranspiration

Hazardous Substance: (1) Any material that poses a threat to human health and/or the environment. Typical hazardous substances are toxic, corrosive, ignitable, explosive, or chemically reactive; (2) Any substance named by EPA to be reported if a designated quantity of the substance is spilled in the waters of the United States or if otherwise emitted into the environment.

Hazardous Waste: By-products of society that can pose a substantial or potential hazard to human health or the environment when improperly managed. Possesses at least one of four characteristics (flammable, corrosivity, reactivity, or toxicity), or appears on special EPA lists.

Hillside: Property located in an area with known erosive soil conditions, where the development contemplates grading on any natural slope that is 25 percent or greater.

Hydrodynamic Separation: Flow-through structures with a settling or separation unit to remove sediments and other pollutants in which no outside power source is required, because the energy of the flowing water allows the sediments to efficiently separate. Depending on the type of unit, this separation may be by means of swirl action or indirect filtration.

Illegal Discharges: Any discharge to a municipal separate storm sewer that is not composed entirely of stormwater except discharges authorized by an NPDES permit (other than the NPDES permit for discharges from the municipal separate storm sewer) and discharges resulting from fire fighting activities.

Impervious Surface / Area: A hard surface area which either prevents or retards the entry of water into the predevelopment soil mantle. A hard surface area which

causes water to run off the surface in greater quantities or at an increased rate of flow from the flow present under predevelopment conditions. Common impervious surfaces include, but are not limited to, roof tops, walkways, patios, driveways, parking lots or storage areas, (impermeable) concrete or asphalt paving, gravel roads, packed earthen materials, and oiled macadam or other surfaces which similarly impede the natural infiltration of storm water.

Industrial General Permit: A NPDES permit issued by the State Water Resources Control Board for the discharge of Stormwater associated with industrial activity.

Infiltration: The downward entry of water into the surface of the soil.

Infiltration Trench: A linear excavation, backfilled with gravel, used to filter pollutants and infiltrate storm water.

Integrated Pest Management Plan (IPMP): A balanced approach to pest management which incorporates the many aspects of plant health care in ways that mitigate harmful environmental impacts and protect human health.

Inlet: An entrance into a ditch, storm sewer, or other waterway.

Legacy Pollutants: Pollutants that are no longer in production but remain in site soils and groundwater and still have the potential to cause ecological and water quality impacts.

Maximum Extent Practicable (MEP): means the standard for implementation of stormwater management programs to reduce pollutants in storm water. CWA § 402(p)(3)(B)(iii) requires that municipal permits "shall require controls to reduce the discharge of pollutants to the maximum extent practicable, including management practices, control techniques and system, design and engineering methods, and such other provisions as the Administrator or the State determines appropriate for the control of such pollutants. See also Los Angeles Regional Water Quality Control Board in 2009 ([Order 09-0057](#))

Material Storage Areas: On site locations where raw materials, products, final products, by-products, or waste materials are stored.

Municipal Separate Storm Sewer System (MS4) Permit: : A NPDES permit issued by the Regional Water Quality Control Board for the discharge of Stormwater from Municipal Separate Storm Sewer Systems.

New Development: Land disturbing activities; structural development, including construction or installation of a building or structure, creation and replacement of impervious surfaces; and land subdivision.

Non-Stormwater Discharge: Any discharge to municipal separate storm drain that is not composed entirely of stormwater. Discharges containing process

wastewater, non-contact cooling water, or sanitary wastewater are non-stormwater discharges.

Non-Structural Source Control Measure: Low technology, low cost activities, procedures or management practices designed to prevent pollutants associated with site functions and activities from being discharged with Stormwater runoff. Examples include good housekeeping practices, employee training, standard operating practices, inventory control measures, etc.

Notice of Intent (NOI): A formal notice to State Water Resources Control Board submitted by the owner/developer that a construction project is about to begin. The NOI provides information on the owner, location, type of project, and certifies that the permittee will comply with the conditions of the construction general permit.

NPDES Permit: An authorization, license, or equivalent control document issued by EPA or an approved State agency to implement the requirements of the NPDES program.

Operations and Maintenance (O&M): The continuing activities required to keep storm water management facilities and their components functioning in accordance with design objectives.

Outfall: The point where stormwater discharges from a pipe, channel, ditch, or other conveyance to a waterway.

Parking Lot: Land area or facility for the temporary parking or storage of motor vehicles used personally, for business or for commerce with an impervious surface area of 5,000 square feet or more, or with 25 or more parking spaces.

Permeability: A property of soil that enables water or air to move through it. Usually expressed in inches/hour or inches/day.

Pervious Surface/Area: A surface or area with a surface (i.e., soil, loose rock, permeable pavement, etc.) that allows water to infiltrate (soak) into the ground.

Planter Box: A structural facility filled with topsoil and gravel and planted with vegetation. The planter is completely sealed, and a perforated collection pipe is placed under the soil and gravel, along with an overflow provision, and directed to an acceptable destination point. The storm water planter receives runoff from impervious surfaces, which is filtered and retained for a period of time.

Pollutant: An elemental or physical material that can be mobilized or dissolved by water or air and creates a negative impact to human health and/ or the environment. Pollutants include suspended solids (sediment), heavy metals (such as lead, copper, zinc, and cadmium), nutrients (such as nitrogen and phosphorus), bacteria and viruses, organics (such as oil, grease, hydrocarbons, pesticides, and fertilizers), floatable debris, and increased temperature.

Pollutants of Concern: Pollutants that exhibit one or more of the following characteristics: current loadings or historic deposits of the pollutant are impacting the beneficial uses of a receiving water, elevated levels of the pollutant are found in sediments of a receiving water and/or have the potential to bioaccumulate in organisms therein, or the detectable inputs of the pollutant are at concentrations or loads considered potentially toxic to humans and/or flora and fauna.

Pollution Reduction: The practice of filtering, retaining, or detaining surface water runoff during and after a storm event for the purpose of maintaining or improving surface and/or groundwater quality.

Precipitation: Any form of rain or snow.

Predevelopment: The existing land use condition prior to the proposed development activity.

Practicable: Available and capable of being done, after taking into consideration existing technology, legal issues, and logistics in light of overall project purpose.

Pretreatment: Treatment of wastewater before it is discharged to a wastewater collection system.

Process Wastewater: Wastewater that has been used in one or more industrial processes.

Public Facility: A street, right-of-way, park, sewer, drainage, storm water management, or other facility that is either currently owned by the City/County or will be conveyed to the City/County for maintenance responsibility after construction.

Receiving Stream: (for purposes of this Manual only) any natural or man-made surface water body that receives and conveys stormwater runoff.

Redevelopment: Land-disturbing activity that results in the creation, addition, or replacement of 5,000 square feet or more of impervious surface area on an already developed site. Redevelopment includes, but is not limited to: the expansion of a building footprint; addition or replacement of a structure; replacement of impervious surface area that is not part of a routine maintenance activity; and land disturbing activities related to structural or impervious surfaces. It does not include routine maintenance to maintain original line and grade, hydraulic capacity, or original purpose of facility, nor does it include emergency construction activities required to immediately protect public health and safety. Note: redevelopment as defined here is not the same as a “Redevelopment Project” as defined by California redevelopment law.

Restaurant: A stand-alone facility that sells prepared foods and/or drinks for consumption, including stationary lunch counters and refreshment stands selling prepared foods and/or drinks for immediate consumption (SIC code 5812).

Retail Gasoline Outlet: Any facility engaged in selling gasoline and lubricating oils.

Retention Facility: A facility designed to receive and hold stormwater runoff. Rather than storing and releasing the entire runoff volume, retention facilities permanently retain a portion of the water on-site, where it infiltrates, evaporates, or is absorbed by surrounding vegetation. In this way, the full volume of storm water that enters the facility is not released off-site.

Retrofit: Retrofit projects implement structural treatment BMPs as a stand-alone project, without other site improvements. The BMP sizing requirements of this Technical Guidance Manual do not apply to retrofit projects.

Runoff: Water originating from rainfall and other precipitations (e.g., sprinkler irrigation) that is found in drainage facilities, rivers, streams, springs, seeps, ponds, lakes, wetlands, and shallow groundwater.

Runon: Stormwater surface flow or other surface flow which enters property other than that where it originated.

Secondary Containment: Structures, usually dikes or berms, surrounding tanks or other storage containers and designed to catch spilled material from the storage containers.

Sedimentation: The process of depositing soil particles, clays, sands, or other sediments that were picked up by runoff.

Sediments: Soil, sand, and minerals washed from land into water usually after rain, that accumulate in reservoirs, rivers, and harbors, destroying aquatic animal habitat and clouding the water so that adequate sunlight might not reach aquatic plants.

Source Control BMP or Measure: Any schedules of activities, structural devices, prohibitions of practices, maintenance procedures, managerial practices or operational practices that aim to prevent Stormwater pollution by reducing the potential for contamination at the source of pollution.

Source Control BMPs: Operational practices or design features that prevent pollution by reducing potential pollutants at the source.

Spill Guard: A device used to prevent spills of liquid materials from storage containers.

Spill Prevention Control and Countermeasures Plan (SPCC): Plan consisting of structures, such as curbing, and action plans to prevent and respond to spills of hazardous substances as defined in the Clean Water Act.

Storm Drains: Above and below ground structures for transporting stormwater to streams or outfalls for flood control purposes.

Storm Drain System: Network of above and below-ground structures for transporting stormwater to streams or outfalls.

Storm Event: A rainfall event that produces more than 0.1 inch of precipitation and is separated from the previous storm event by at least 72 hours of dry weather.

Stormwater Discharge Associated with Industrial Activity: Discharge from any conveyance which is used for collecting and conveying stormwater which is related to manufacturing processing or raw materials storage areas at an industrial plant [see 40 CFR 122.26(b)(14)].

Stormwater: Stormwater runoff, snow-melt runoff, surface runoff, and drainage, excluding infiltration and irrigation tailwater.

Structural BMP or Control Measure: Any structural facility designed and constructed to mitigate the adverse impacts of stormwater and urban runoff pollution (e.g. canopy, structural enclosure). The category may include both Treatment Control BMPs and Source Control BMPs.

Total Suspended Solids (TSS): Matter suspended in stormwater excluding litter, debris, and other gross solids exceeding 1 millimeter in diameter.

Treatment Control BMP or Measure: Any engineered system designed to remove pollutants by simple gravity settling of particulate pollutants, filtration, biological uptake, media adsorption or any other physical, biological, or chemical process.

Treatment: The application of engineered systems that use physical, chemical, or biological processes to remove pollutants. Such processes include, but are not limited to, filtration, gravity settling, media adsorption, biodegradation, biological uptake, chemical oxidation and UV radiation.

Tributary Area: The area from which all runoff produced flows to the same specific discharge point.

Vegetated Facilities: Stormwater management facilities that rely on plantings to enhance their performance. Plantings can provide wildlife habitat and enhance many facility functions, including infiltration, pollutant removal, water cooling, flow calming, and prevention of erosion.

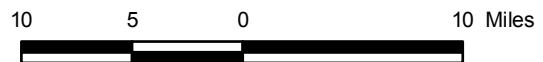
Vegetated Swale: A long and narrow, trapezoidal or semicircular channel, planted with a variety of trees, shrubs, and grasses or with a dense mix of grasses. Stormwater runoff from impervious surfaces is directed through the swale, where it is slowed and in some cases infiltrated, allowing pollutants to settle out. Check dams are often used to create small ponded areas to facilitate infiltration.

APPENDIX B : MAPS



Legend

- | | |
|-----------------------------------|------------------|
| River | Santa Paula |
| Lake | Simi Valley |
| National Forest | Thousand Oaks |
| 10-Digit Hydrologic Unit Boundary | Port Hueneme |
| Existing Urban Area | |
| Camarillo | Ventura |
| Fillmore | Ojai |
| Moorpark | Urban County |
| Oxnard | Non-Urban County |
| | Adjacent County |



**Hydrologic Areas
Ventura County, CA**

Geosyntec
consultants

Figure
B-1

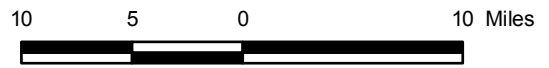
Oakland Office

April 2010



Legend

- | | |
|--------------------------------|------------------|
| RARE Designated Waterbody | Santa Paula |
| 303(d) Listed Waterbody | Simi Valley |
| Environmentally Sensitive Area | Thousand Oaks |
| Lake | Port Hueneme |
| National Forest | Ventura |
| Existing Urban Area | Ojai |
| Camarillo | Urban County |
| Fillmore | Non-Urban County |
| Moorpark | Adjacent County |
| Oxnard | |



**Environmentally Sensitive Areas
Ventura County, CA**

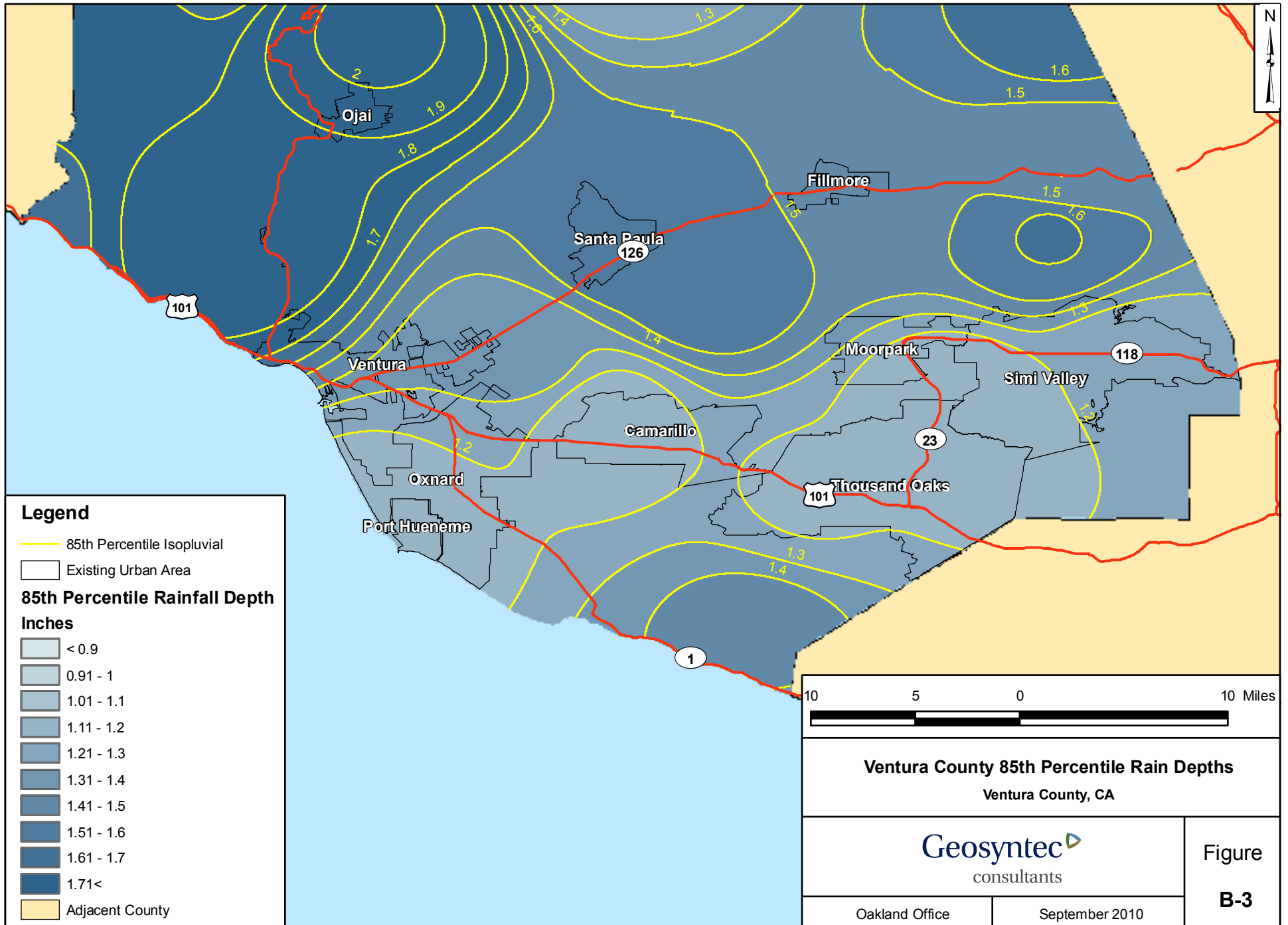
Geosyntec
consultants

Figure

B-2

Oakland Office

April 2010



Legend

- 85th Percentile Isopluvial
- Existing Urban Area

**85th Percentile Rainfall Depth
Inches**

- < 0.9
- 0.91 - 1
- 1.01 - 1.1
- 1.11 - 1.2
- 1.21 - 1.3
- 1.31 - 1.4
- 1.41 - 1.5
- 1.51 - 1.6
- 1.61 - 1.7
- 1.71 <
- Adjacent County

10 5 0 10 Miles

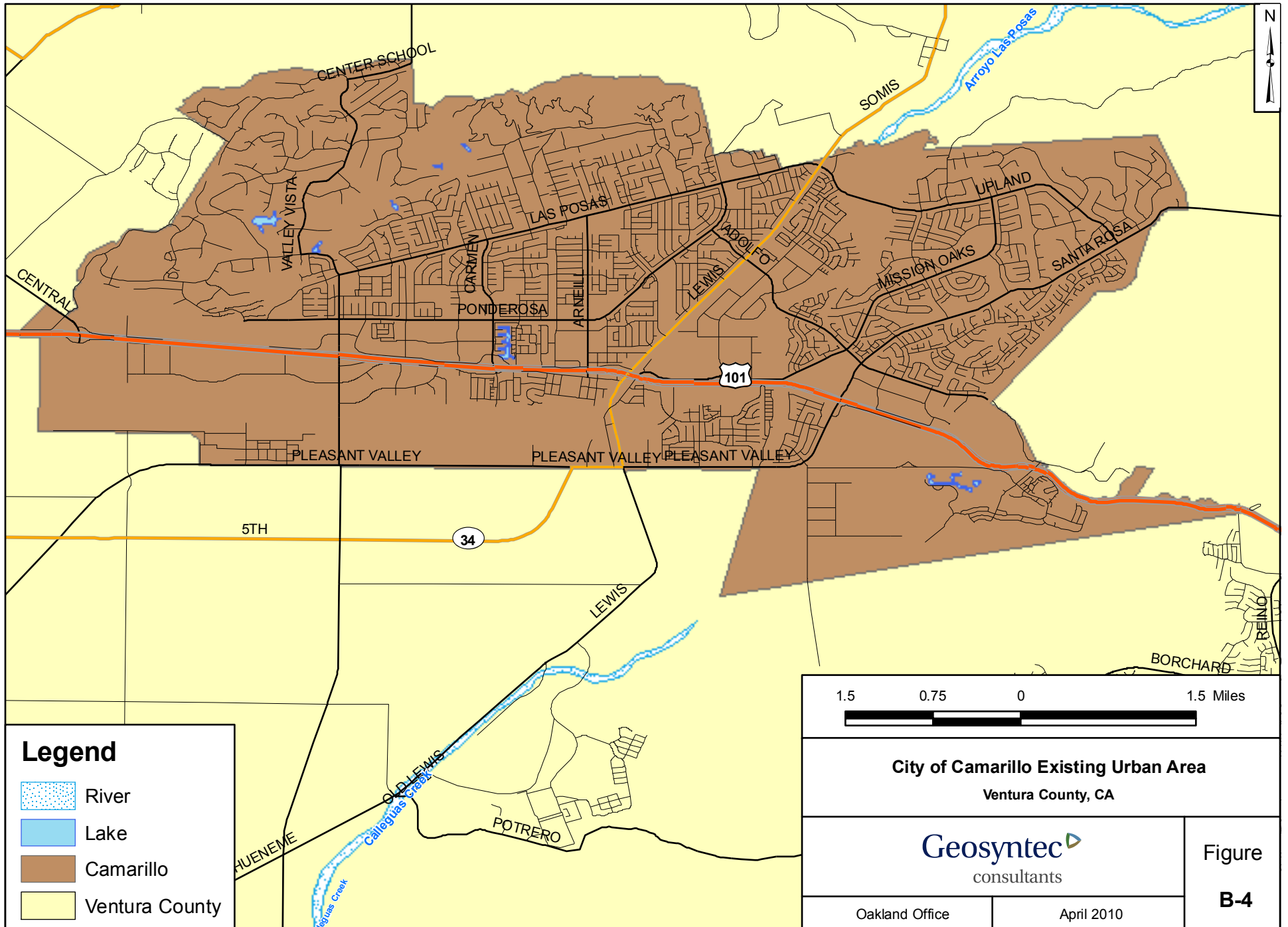
Ventura County 85th Percentile Rain Depths
Ventura County, CA

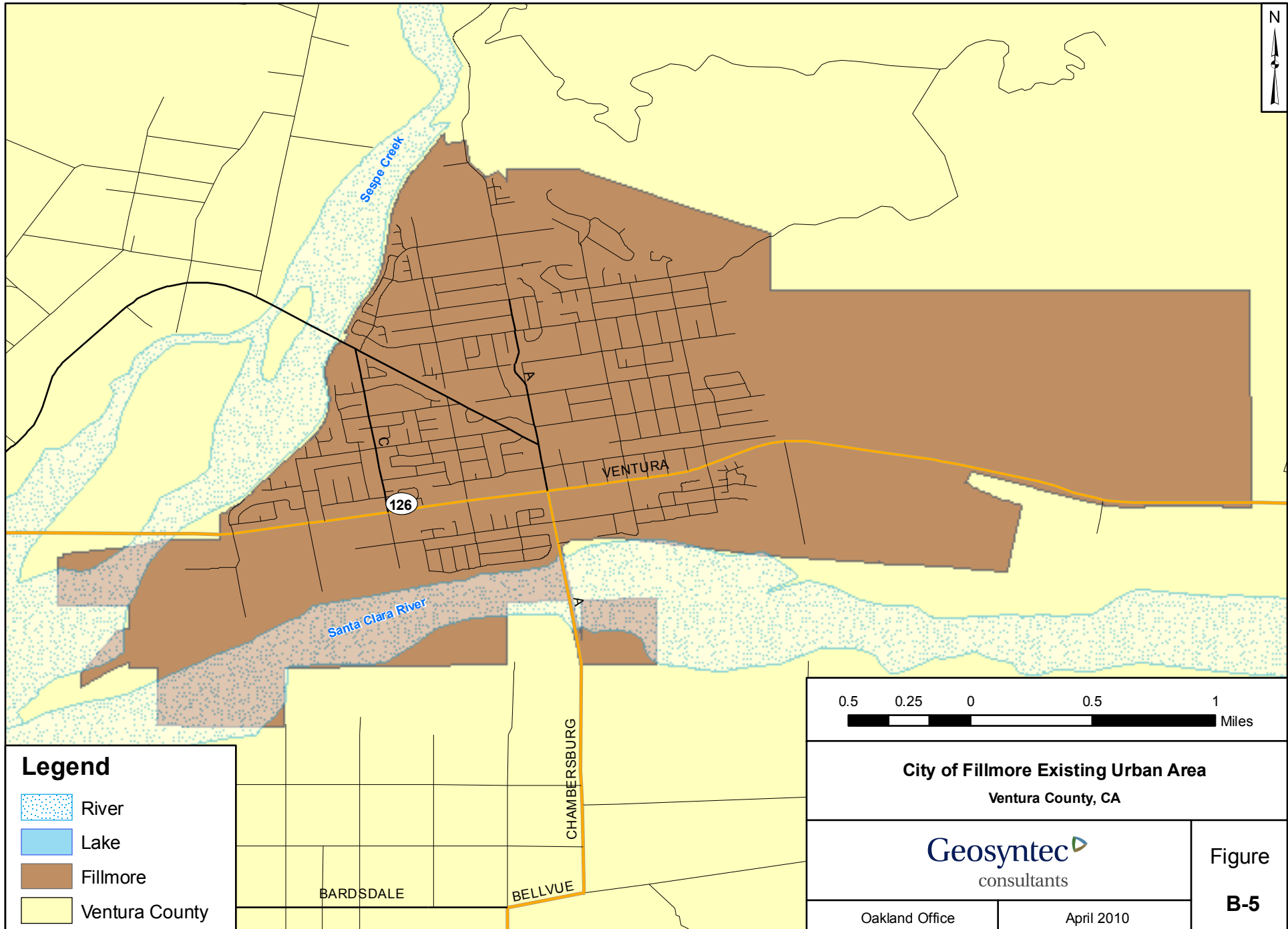
Geosyntec
consultants

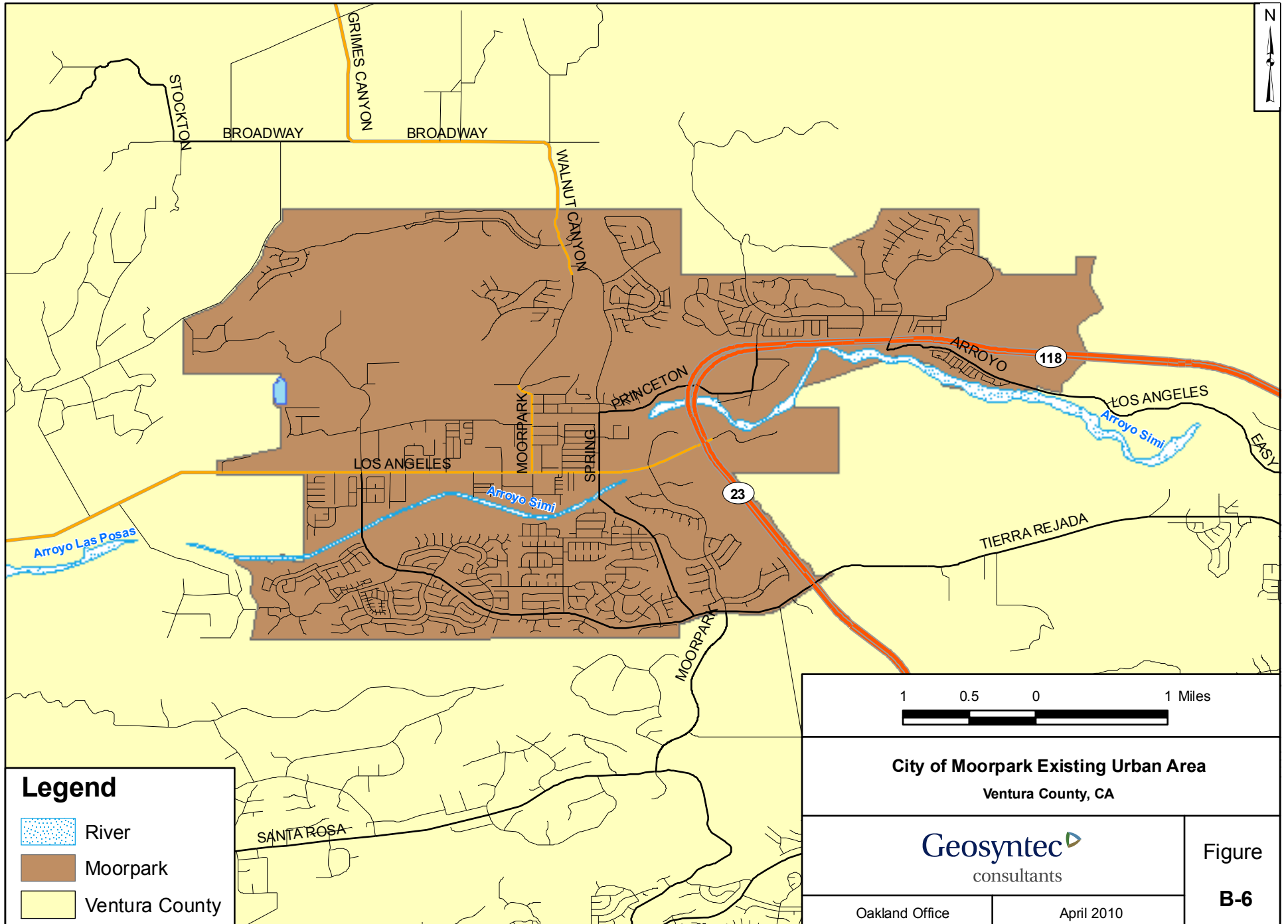
Figure
B-3

Oakland Office




September 2010








Legend

-  River
-  Moorpark
-  Ventura County

1 0.5 0 1 Miles



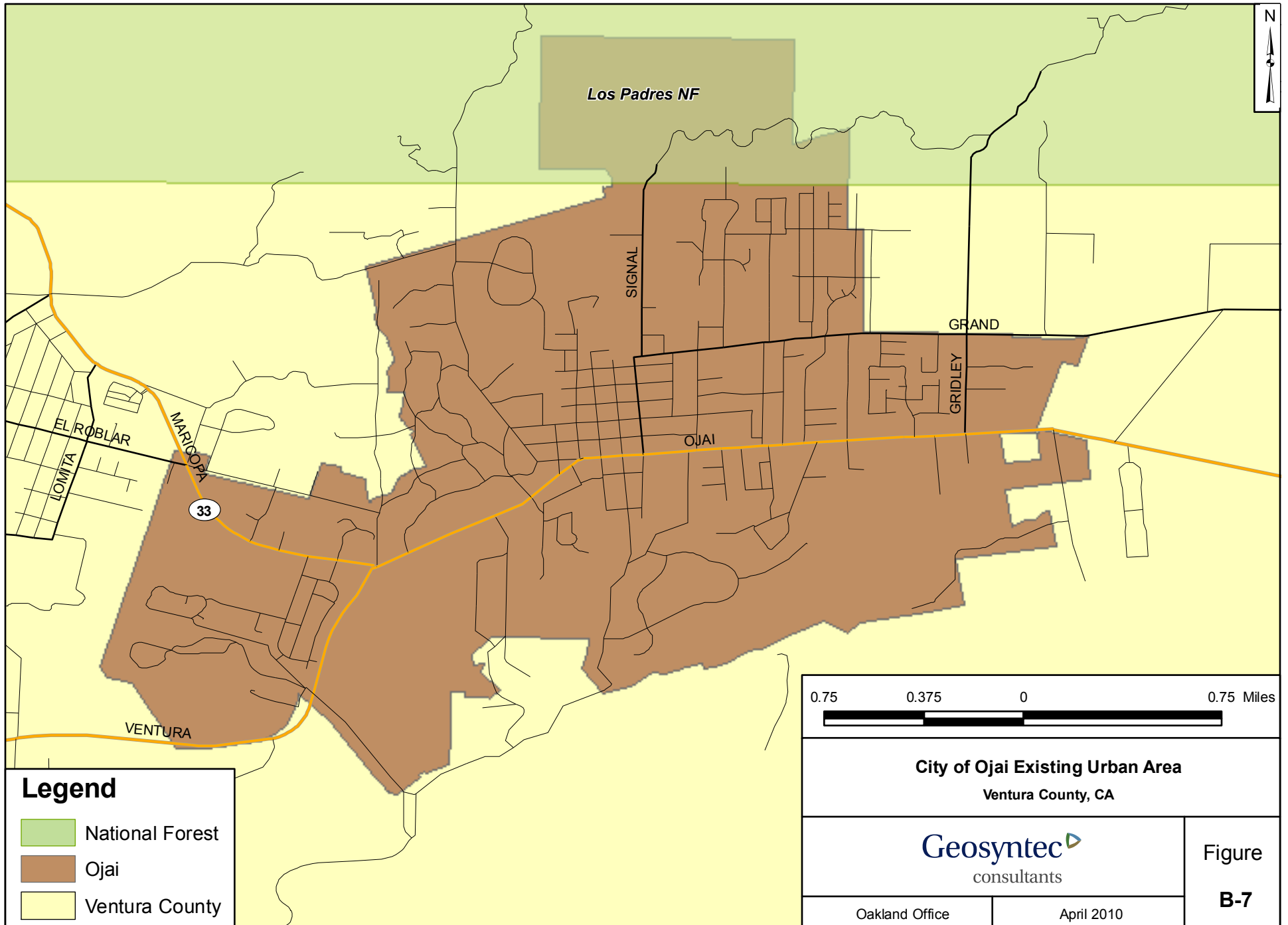
City of Moorpark Existing Urban Area
Ventura County, CA

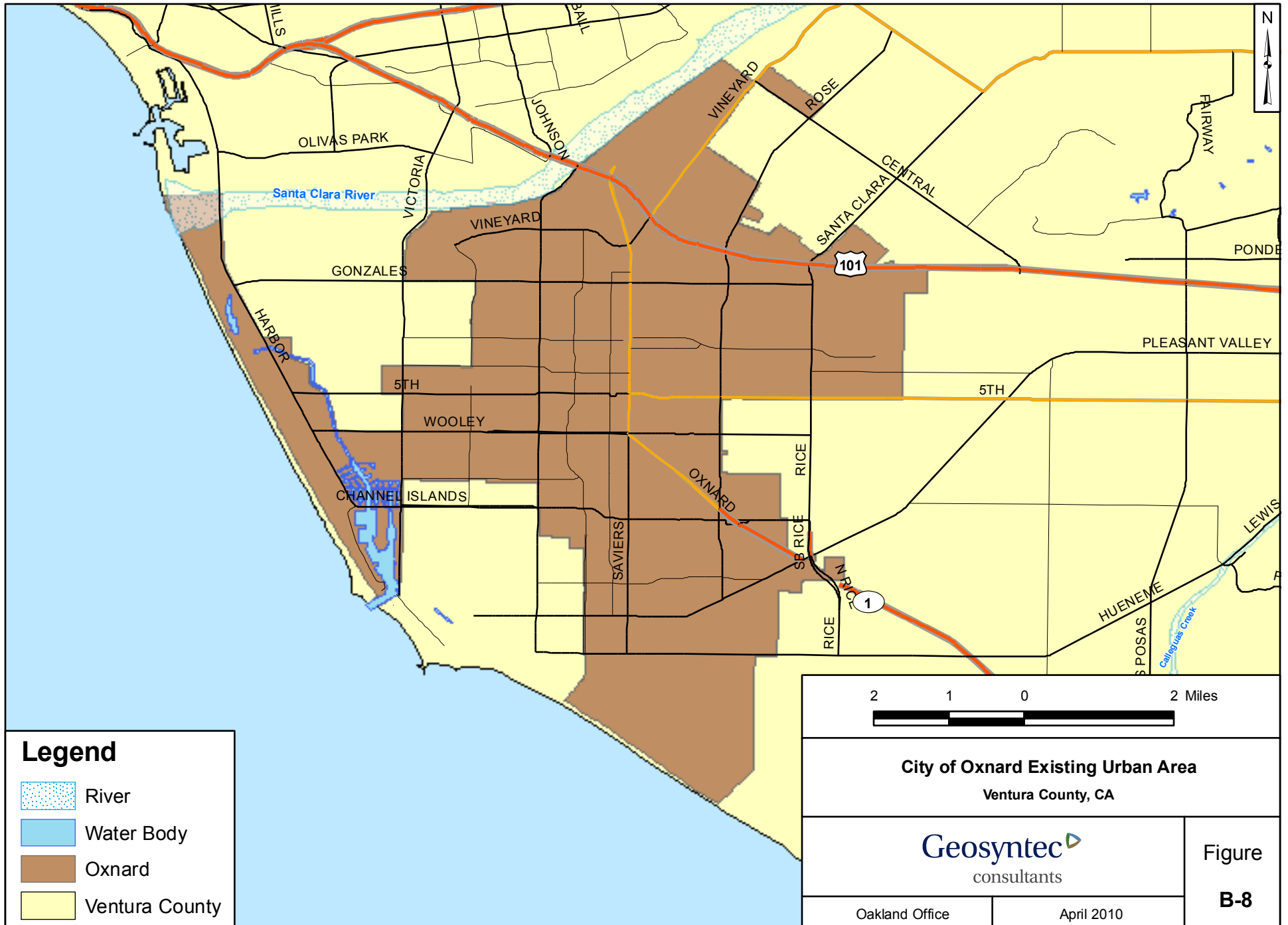
Geosyntec
consultants

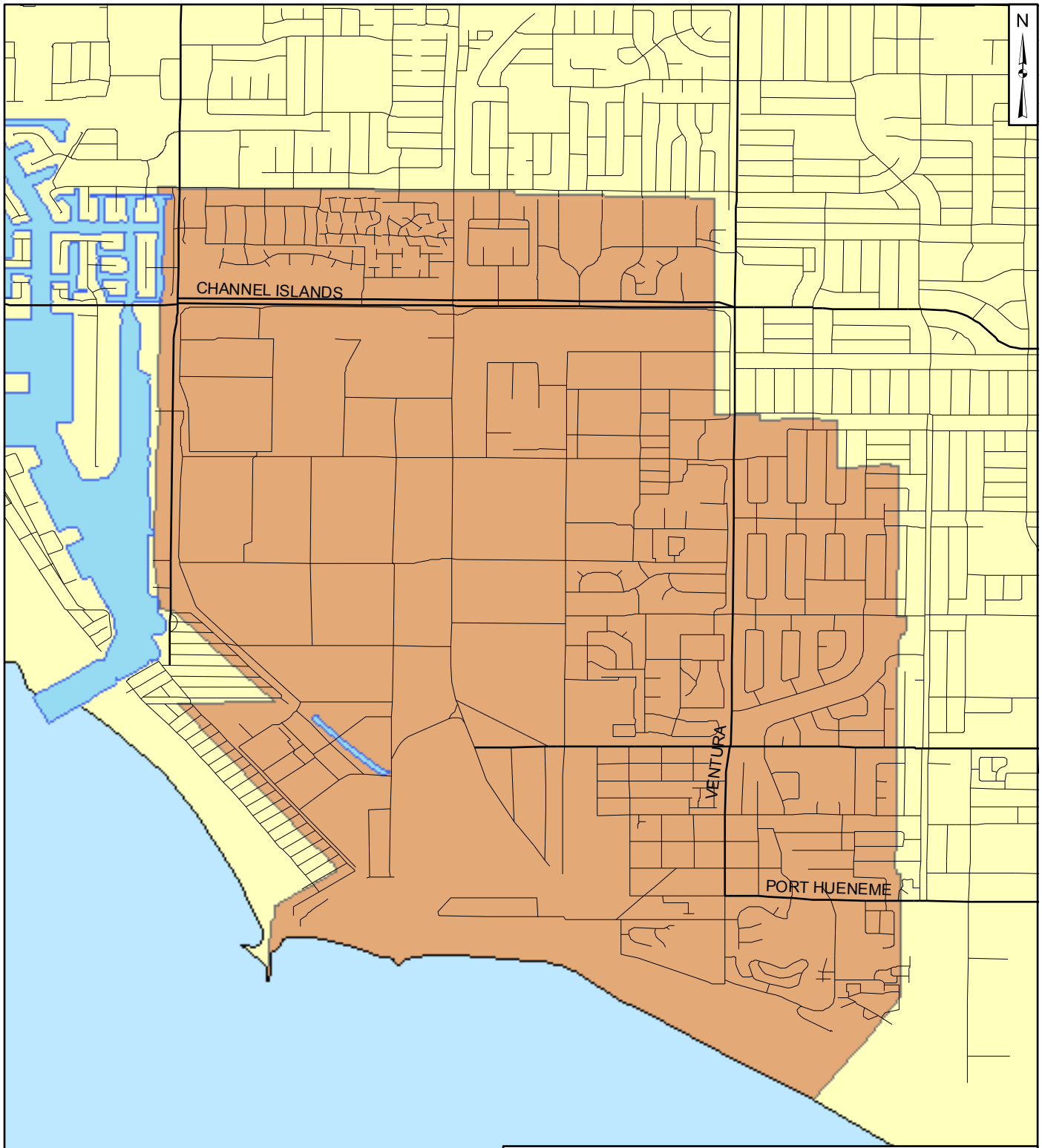
Oakland Office

April 2010

Figure
B-6



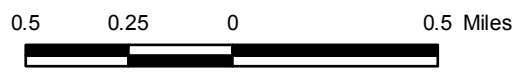








CHANNEL ISLANDS

VENTURA

PORT HUENEME



Legend

-  River
-  Water Boday
-  Port Hueneme
-  Ventura County

City of Port Hueneme Existing Urban Area
Ventura County, CA

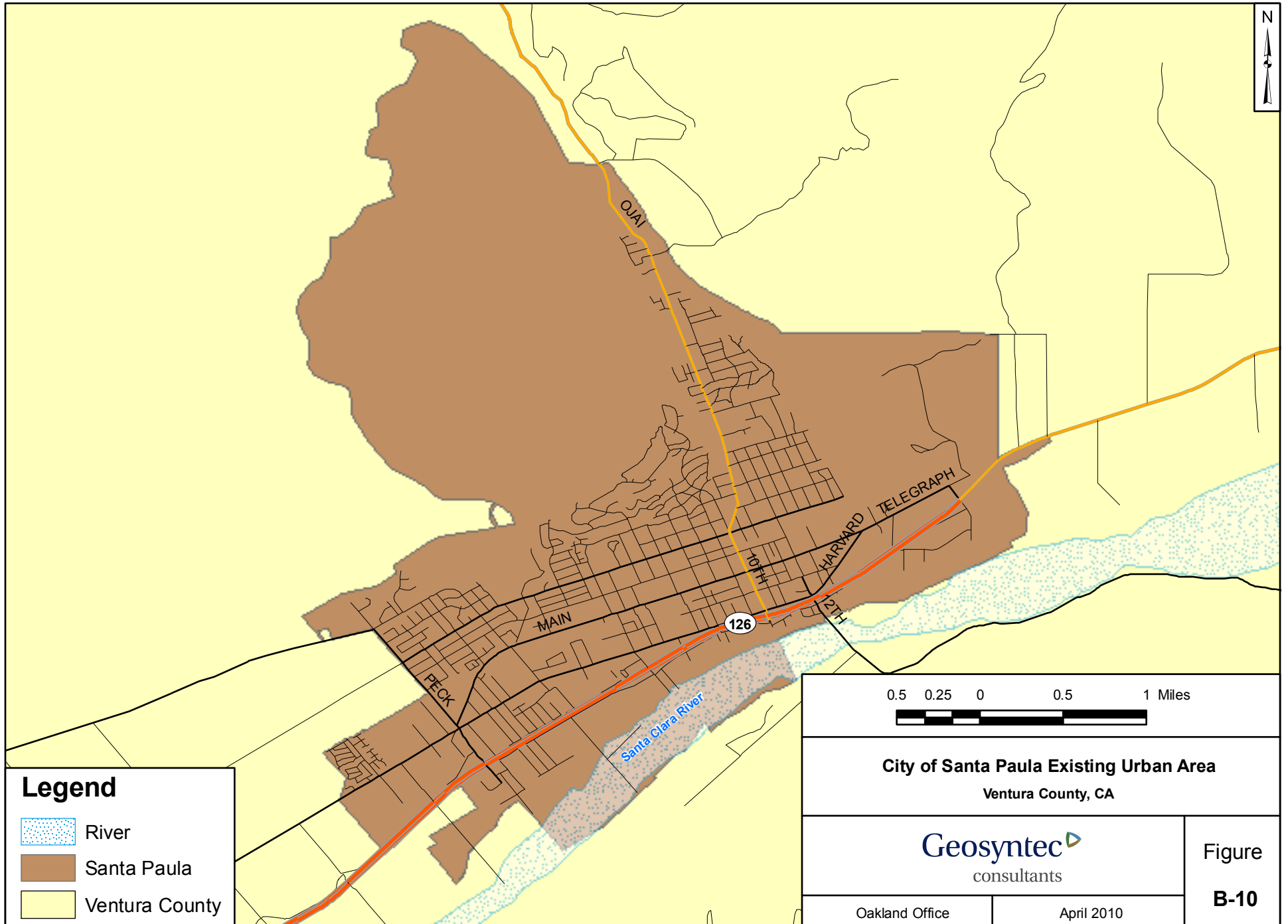


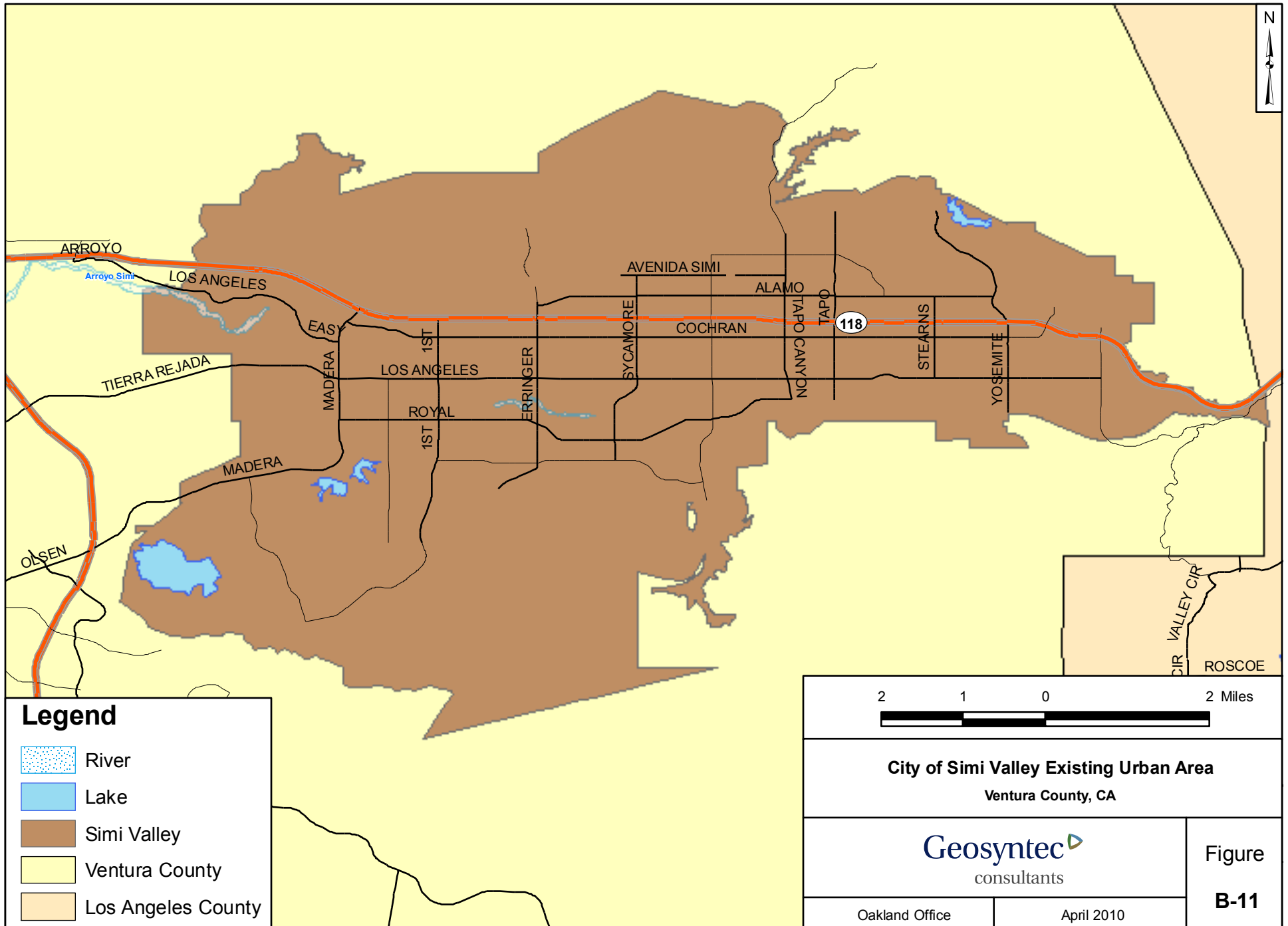
Figure

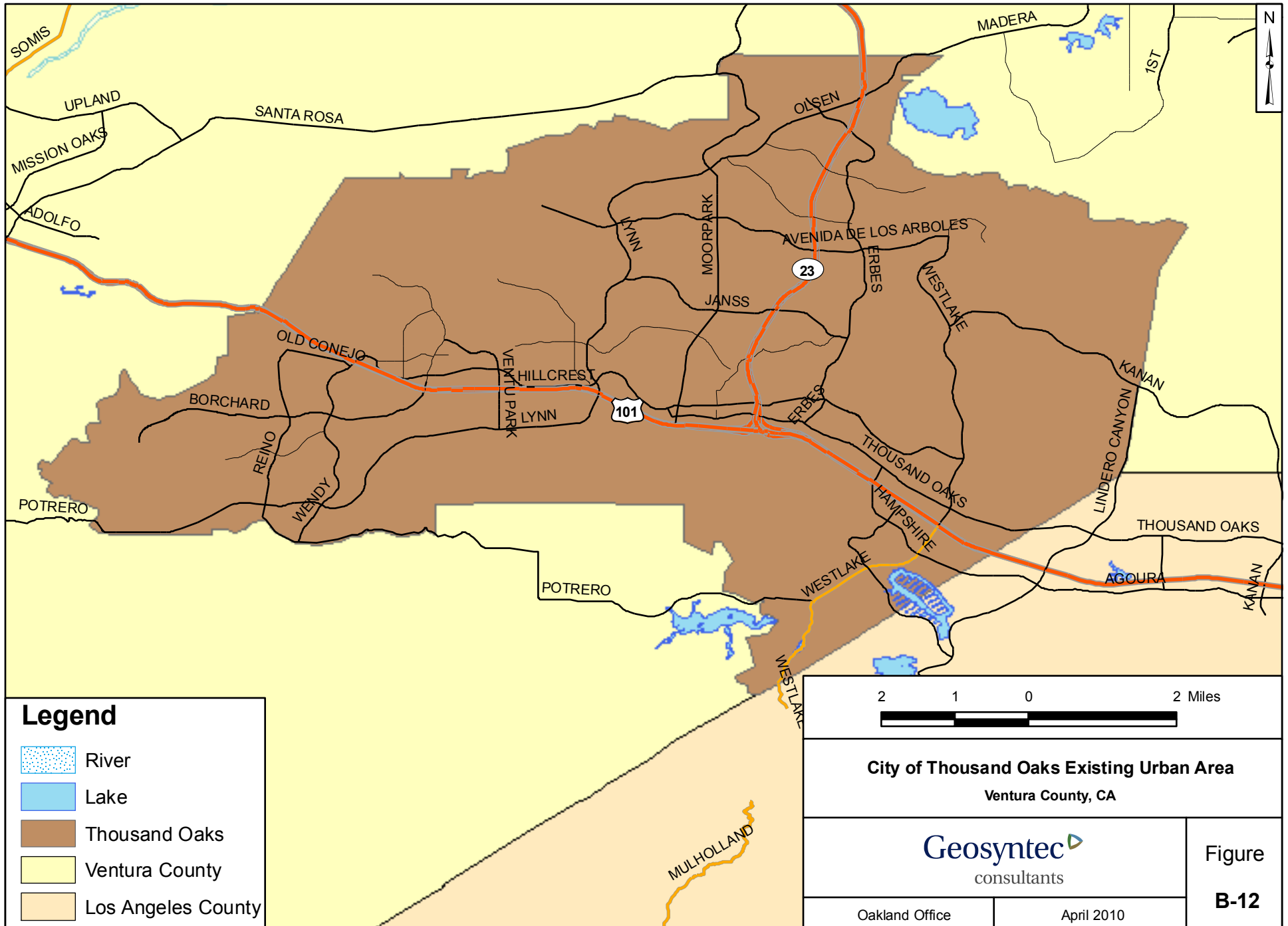
B-9

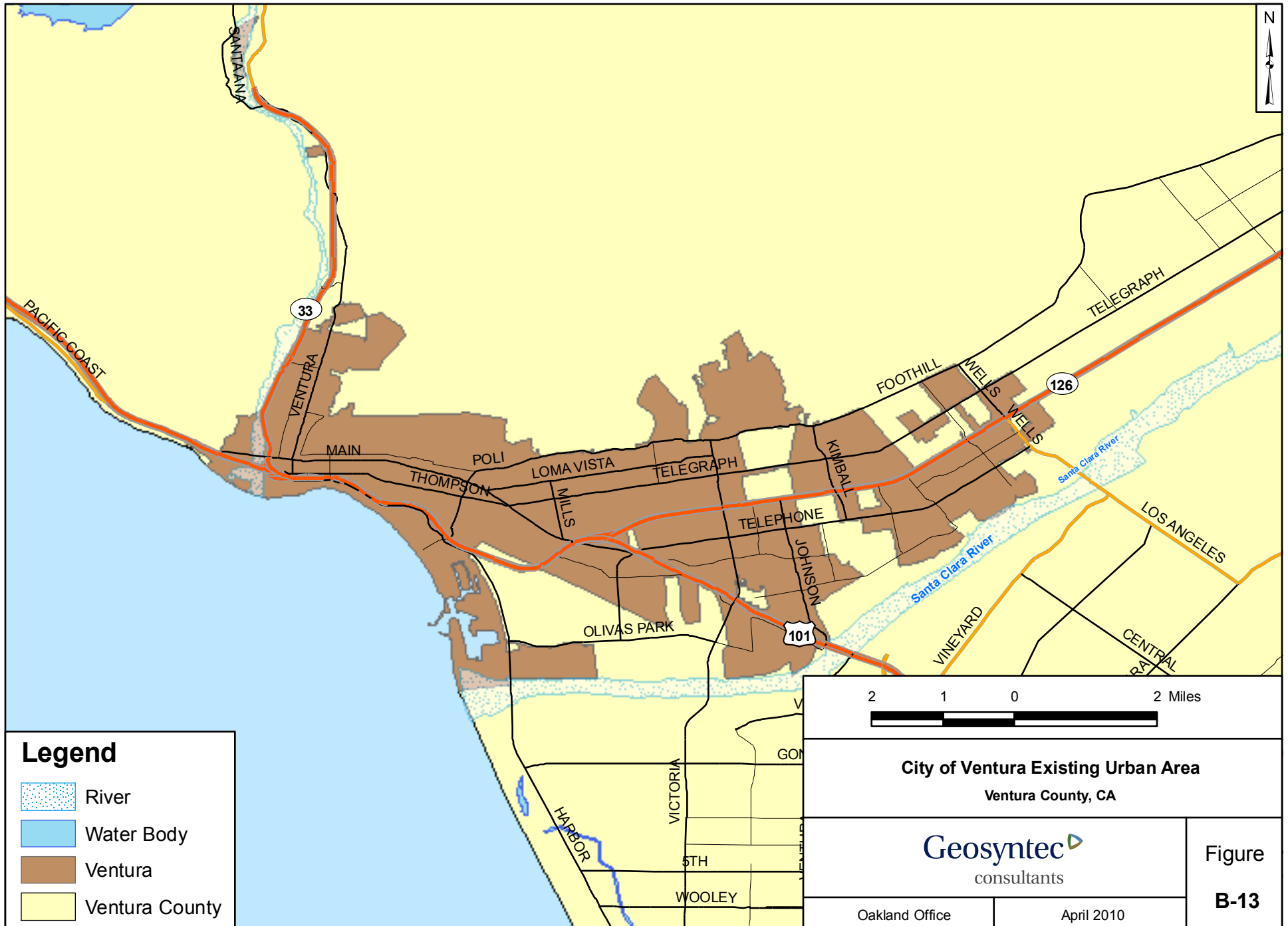
Oakland Office

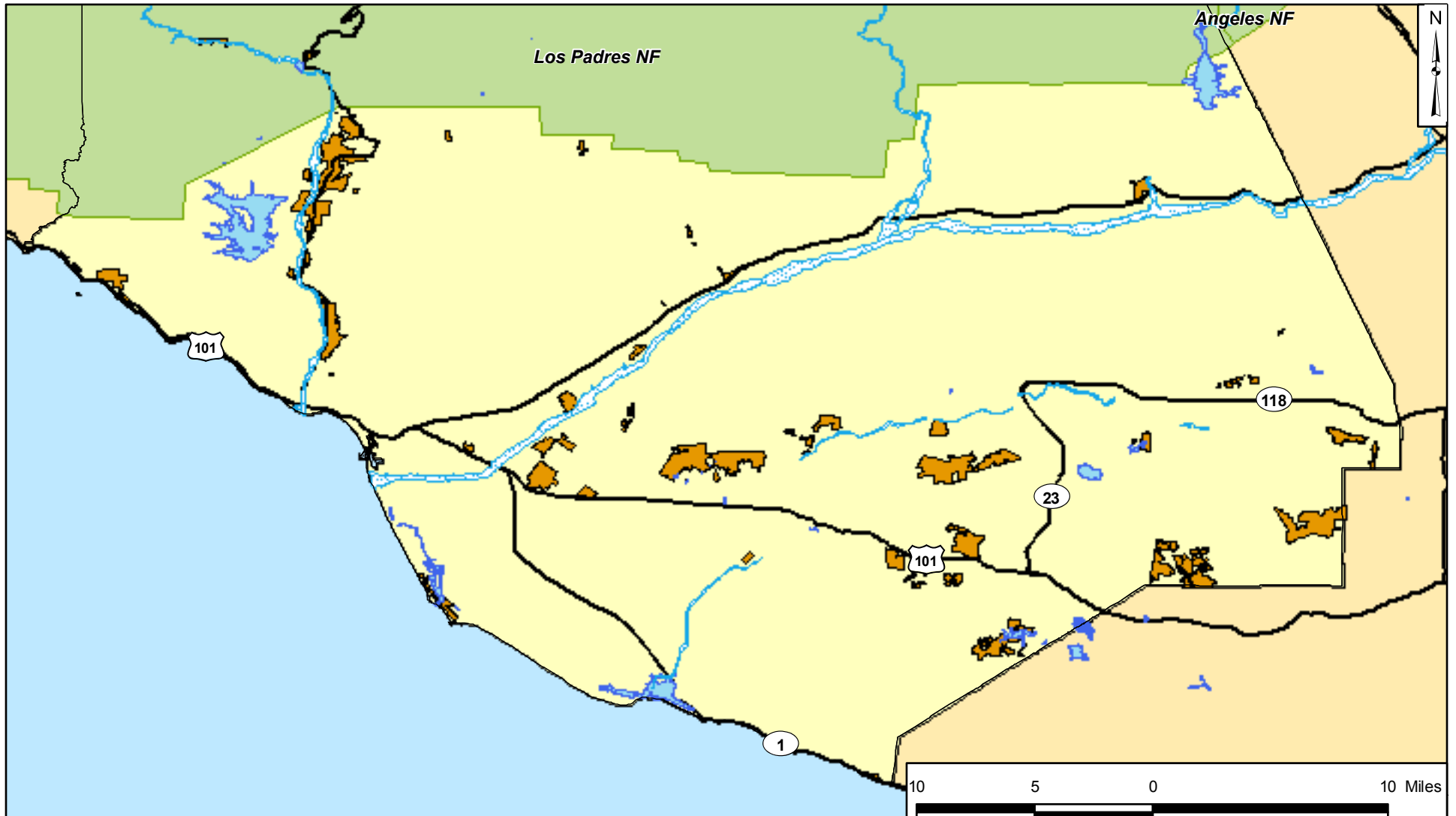
April 2010













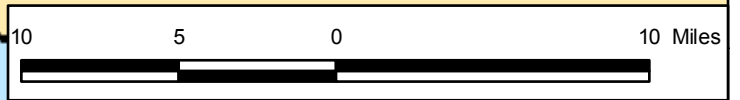




Legend

-  River
-  Lake
-  Unincorporated Urban County
-  National Forest
-  Non-Urban County
-  Adjacent County

Note: An Unincorporated Urban Center is an existing or planned community which is located in an Area of Interest where no city exists. The unincorporated urban center represents the focal center for community and planning activities within an Area of Interest. For example, the Community of Piru represents the focal center in the Piru Area of Interest. This map represents the existing Unincorporated Urban Centers as defined by the Ventura County General Plan.

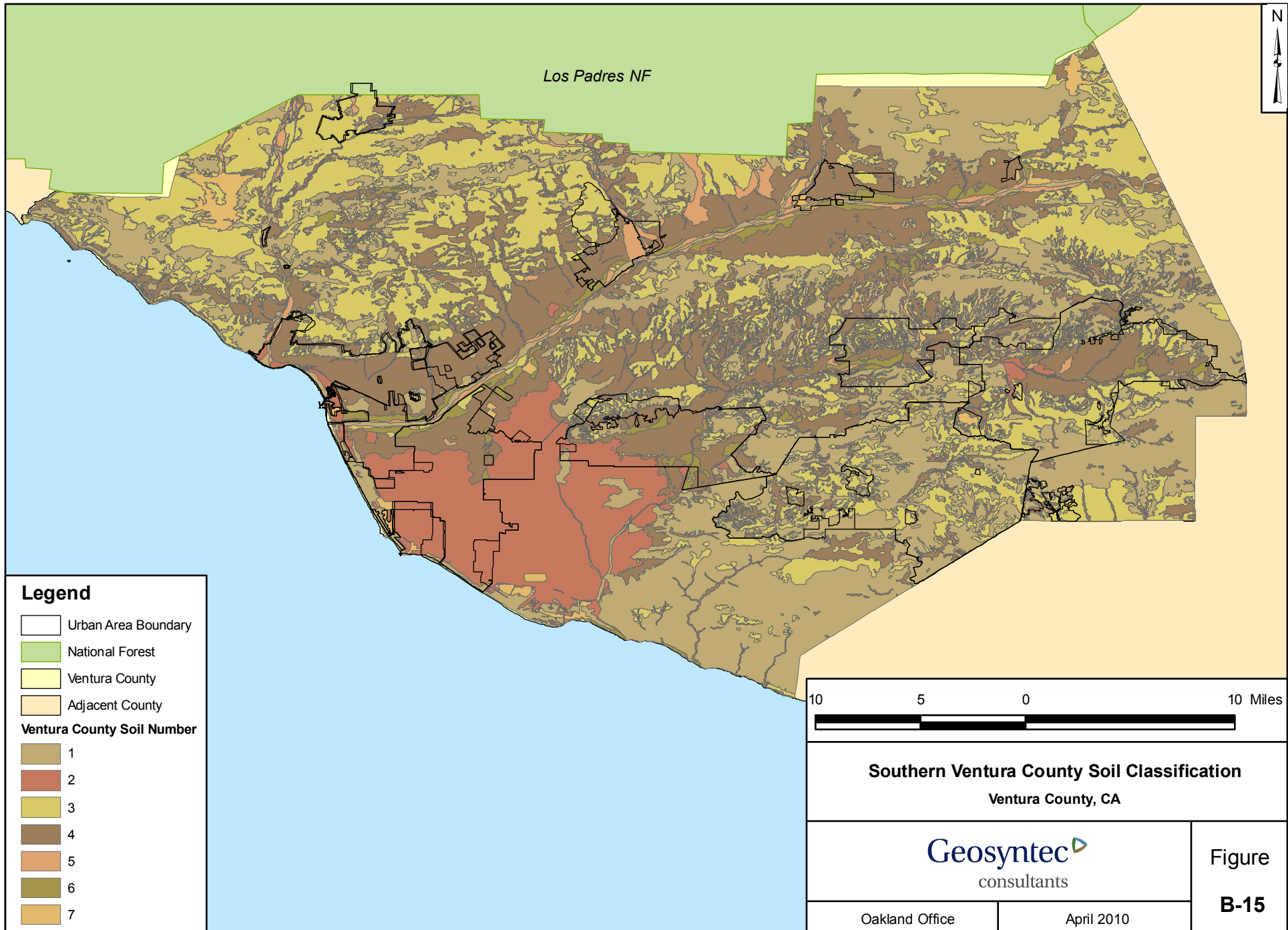


Ventura County Unincorporated Urban Areas
Ventura County, CA

Geosyntec 
consultants

Oakland Office	April 2010
----------------	------------

Figure
B-14



Los Padres NF

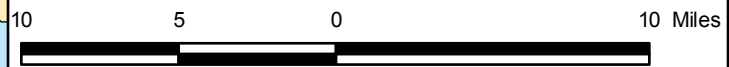


Legend

-  Urban Area Boundary
-  National Forest
-  Ventura County
-  Adjacent County

Ventura County Soil Number

-  1
-  2
-  3
-  4
-  5
-  6
-  7



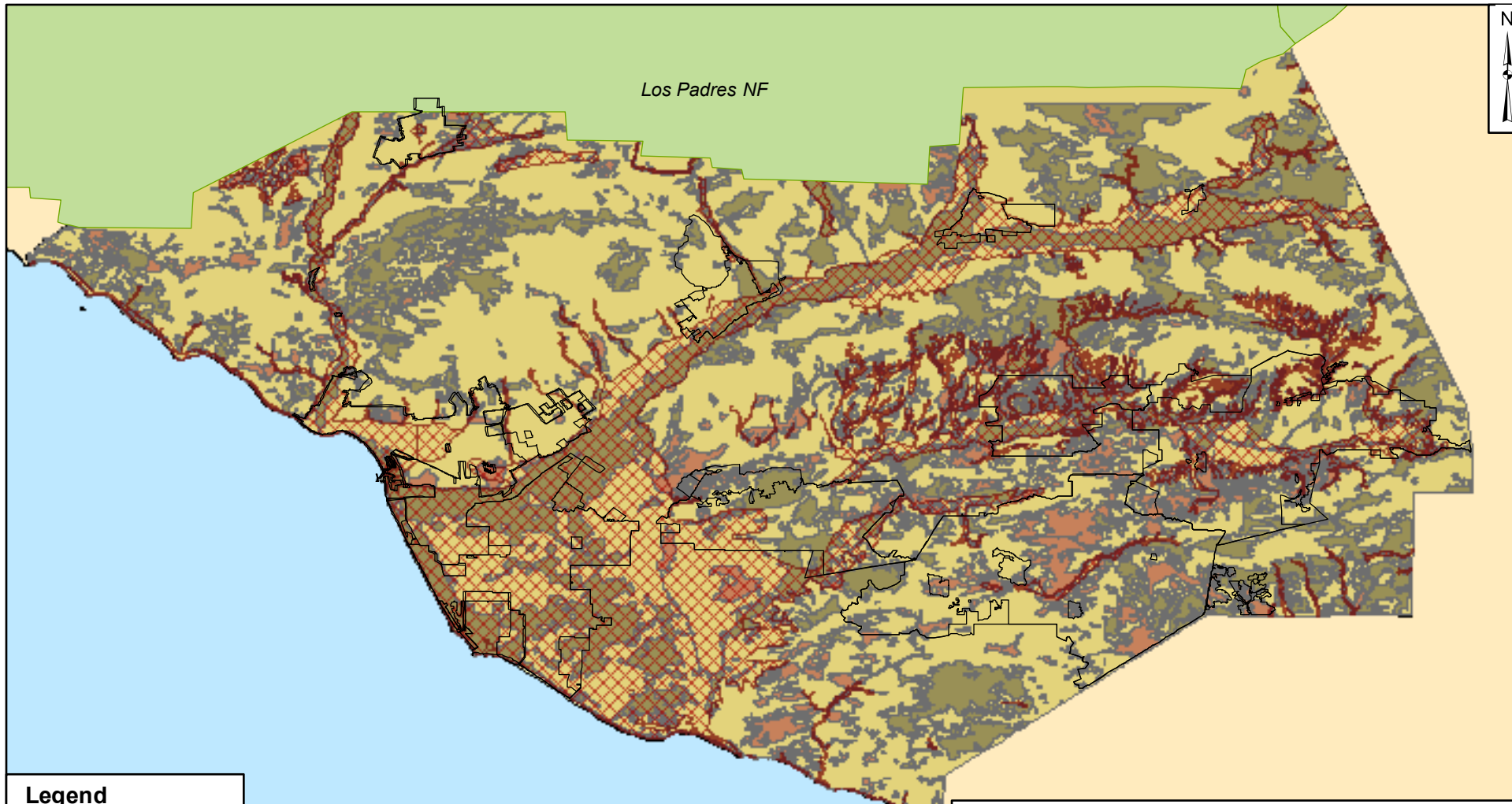
Southern Ventura County Soil Classification
Ventura County, CA

Geosyntec
consultants

Figure
B-15









Oakland Office

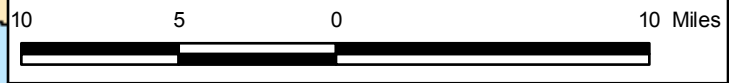
April 2010



Los Padres NF

Legend

-  Urban Area Boundary
-  National Forest
-  Ventura County
-  Adjacent County
-  Liquefaction Potential
- Expansive Soil Potential**
-  High
-  Medium
-  Low



**Southern Ventura County Liquefaction
and Expansive Soil Potential**
Ventura County, CA

Geosyntec
consultants

Figure
B-16

Oakland Office

April 2010

APPENDIX C: SITE SOIL TYPE AND INFILTRATION TESTING

C.1 Introduction

The purpose of site soil and infiltration testing is to more accurately determine where LID and structural treatment BMPs should be located and if infiltration is feasible on the site. The preliminary site assessment, discussed in Section 3, will likely reduce the number of test pit investigations needed by identifying candidate test sites that are most amenable to infiltration. This section summarizes the methods for conducting (1) soil test pit investigations and (2) infiltration testing at key locations identified in the preliminary site assessment that require further investigation.

A qualified soil scientist or geotechnical professional should conduct the test pit investigation and infiltration tests. The professional should be experienced with the testing procedures as well as the hydraulic functioning of the potential BMPs to ensure that additional information regarding BMP siting is acquired during the test pit investigation and infiltration tests.

This appendix is not intended to be applied as a protocol for conducting soil and infiltration testing. Instead, this section is provided to assist in specifying and standardizing soil and infiltration testing techniques across sites within Ventura County where development is occurring.

C.2 Test Pit Investigations

A test pit investigation is an integral part of assessing site soil conditions. Soil maps and hydrologic soil groups are based on regional data and provide only a general understanding of what to expect; however, there are undoubtedly unknowns that will be discovered during these initial field observations. A test pit investigation involves digging or excavating a test pit (deep hole). By excavating a test pit, overall soil conditions (both vertically and horizontally) can be observed in addition to the soil horizons. To maximize the knowledge gained during the test pit investigation, many tests and observations should be conducted during this process.

Test pits should be excavated to a depth at least three feet deeper than the proposed bottom of non-infiltration BMPs and at least eleven feet deeper than the proposed bottom of infiltration BMPs. A project that imports fill must characterize the proposed soil profile at the specified depths. For example, if the proposed depth of fill is 5 feet below grade and an infiltration BMP is to be used in the location of the fill, both the fill and the native subsoil require soil characterization. Figure C-1 illustrates the proposed soil profile that would result with 3 feet of fill. Since the test pit must be excavated to a depth that is 11 feet deeper than the bottom of the proposed infiltration BMP, a test pit investigation of the top 8 feet of native subsoil is required, in addition to the laboratory sample of the fill material. Characterization of the fill material should be conducted in a laboratory. It is recommended that soil compaction is limited in the location of a proposed infiltration BMP.

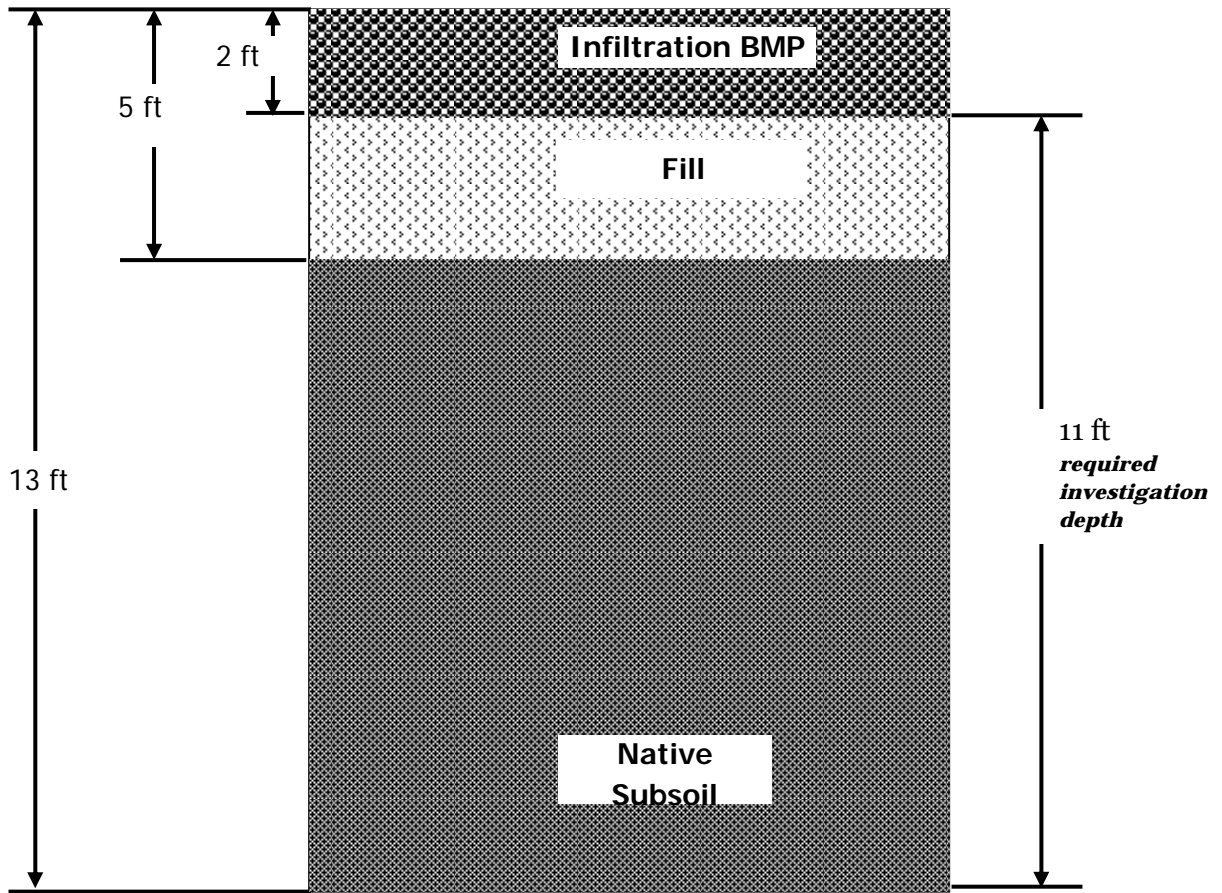


Figure C-1: Post-fill Soil Profile

As the test pit is excavated, the following measurements should be made:

Standard penetration testing to determine the relative density as it changes with depth (minimum intervals of 2 - 3 feet), and

Infiltration testing with at least one test occurring at the proposed bottom of the BMP and one test occurring at the bottom of the test pit (11 feet below the bottom of the infiltration BMP).

In addition, many observations should be made during and after the excavation of the soil pit, including:

- Elevation of groundwater table or indications of seasonally high groundwater table should be noted using the NRCS hydric soil field indicators guide (NRCS, 2003).
- Soil horizon observations, including: depths indicating upper and lower boundaries of the soil horizons, depths to limiting layers (i.e., bedrock and clay), soil textures, colors and their patterns, and estimates of the type and percent of coarse fragments.

- Locations and descriptions of macropores (i.e., pores and roots).
- Other pertinent information/observations.

The number of test pits required depends largely on the specific site and the proposed development plan. Additional tests should be conducted if local conditions indicate significant variability in soil types, geology, water table elevations, bedrock, topography, etc. Similarly, uniform site conditions may indicate that fewer test pits are required. Excessive testing and disturbance of the soil prior to construction is not recommended. When test pit investigations are complete, including infiltration testing, the pits should be refilled with the original soil and the surface replaced with the original topsoil.

C.3 Infiltration Testing

There are a variety of infiltration field test methodologies available to determine the infiltration rate of a soil. Infiltration tests should be conducted in the field in order to ensure that the measurements are representative of actual site conditions (including inherent heterogeneity). As mentioned above, usually infiltration rates should be determined at a minimum of two locations in each test pit and one must be conducted at the proposed bottom depth of the BMP. The actual number of infiltration tests required depends on the soil conditions; if the soils are highly variable, more tests may be required. To ensure groundwater is protected and that the infiltration BMP is not rendered ineffective by overload, it is important to periodically verify infiltration rates of the constructed BMP(s).

For BMPs that infiltrate water through the surface soil layer (e.g., bioretention areas, permeable pavement), choosing a method that measures infiltration in surface soils is important. For infiltration trenches and drywells, infiltration will occur at a greater depth in the soil matrix; therefore, borehole methods may be more appropriate.

Depending on the type of infiltration BMP and depth at which the infiltration test should be conducted, there are several types of infiltration tests that can be used including: disc permeameters, single and double ring infiltrometers, and borehole permeameters. Disc permeameters are typically used to provide estimates of soil near saturation but can prove to be difficult due to measures of three dimensional flow. This device is also commonly used for assessing infiltration rates of already constructed permeable pavements and is generally not used for assessing infiltration rates prior to site disturbance; therefore, the disc permeameter method will not be discussed further in this Appendix. Single and double ring infiltrometers directly measure vertical flow into the surface of the soil. Double ring infiltrometers account for lateral flow boundary affects with the addition of an outer water reservoir and are generally the preferred method for surface infiltration. Borehole permeameters are best suited to collect infiltration measurements below the soil surface. Two subsurface infiltration methods are discussed below including the Guelph and falling-head permeameters.

C.4 Double Ring Infiltrometer

The double ring infiltrometer method consists of driving two cylinders, one inside the other, into the ground and partially filling them with water and maintaining the liquid at a constant level (ASTM D3385-94). The volume of water added to the inner ring from a separate water reservoir, to maintain the constant head level is comparable to the volume of water infiltrating into the soil. The volume of water added to the inner ring divided by the time period for which the water was added is equal to the infiltration rate. A photograph of a common double ring infiltrometer is provided in Figure C-2.



Figure C-2: Double Ring Infiltrometer

Photo Credit: Geosyntec Consultants (Braga and Fitsik, 2008)

C.5 Borehole Guelph Infiltration Test

For shallow boreholes, the Guelph Permeameter has been developed as a field portable kit. This permeameter consists of a tube that is placed in a hand-drilled shallow borehole and water is provided to the tube through a separate reservoir. Water loss in the reservoir is used to estimate the hydraulic conductivity of the soil, which may be used to calculate infiltration based on various standard models (Soil Moisture Equipment, 2005). A photograph of a Guelph Permeameter is provided in Figure C-3. It is important to remember that this method will include vertical and lateral water flow from the borehole.

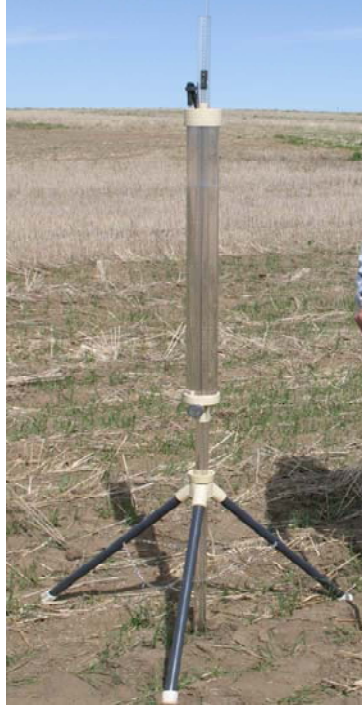


Figure C-3: Guelph Permeameter for Shallow Borehole Permeability

Photo Credit: USDA, 2005

C.6 Falling-Head Borehole Infiltration Test

The falling-head borehole infiltration test is commonly applied to assess infiltration at greater depths (e.g. 5 - 25 ft). The method is generally performed according to United States Bureau of Reclamation procedure 7300-89 (USBR, 1990). Caltrans has used the method to site stormwater infiltration structures (Caltrans, 2003). Essentially the method consists of boreholes, installing well casing with slots cut to release water at the target depths, backfilling the borehole, adding pre-soak water, and then filling again with water and recording the stage loss. An example diagram is shown in Figure C-4.

The testing procedures are summarized as follows:

- 1) Remove any smeared soil surfaces to provide a natural soil interface for testing the percolation of water. Remove all loose material. The U.S. EPA recommends scratching the sides with a sharp pointed instrument. (Note: upon tester's discretion, a 2-inch layer of coarse sand or fine gravel may be placed to protect the bottom from scouring and sediment.) Fill casing with clean water and allow to pre-soak for 24 hours or until the water has completely infiltrated.
- 2) Refill casing and monitor water level (distance from top of casing to top of water) for 1 hour. Repeat this procedure a total of four times. (Note: upon tester's discretion, the final field rate may either be the average of the four observations

or the value of the last observation. The final rate shall be reported in inches per hour.)

- 3) Testing may be done through a boring or open excavation.
- 4) The location of the test must be near the proposed facility.
- 5) Upon completion of the testing, the casings shall be immediately pulled and the test pit shall be back-filled.

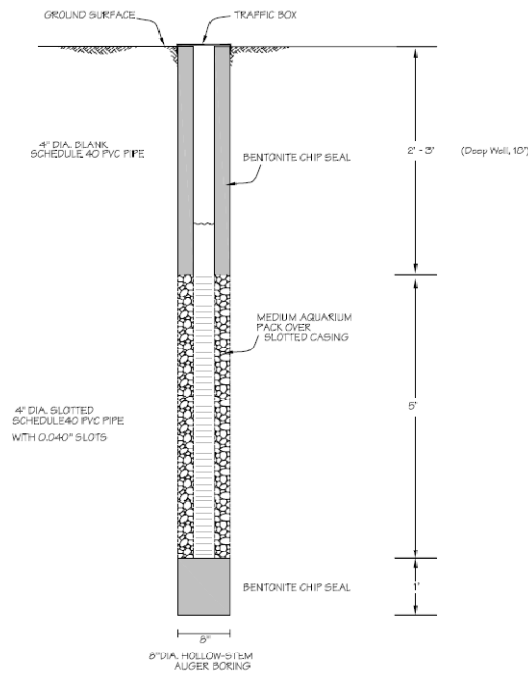


Figure C-4: Falling-Head Permeameter for Deep Borehole Permeability

Diagram Credit: Group Delta Consultants, 2008

C.7 Laboratory Soil Tests

If fill materials imported from off-site are part of an infiltration BMP design, a laboratory test is required to determine the infiltration rate of the fill soil. A sample of the fill soil from each area where a BMP will be located must be tested. The soil sample must be compacted to the same degree that will be present after final grading. Once prepared, the sample should be sent to a specialty laboratory to conduct a test of the infiltration rate. These results may then be used to assess the applicability of a specific BMP.

C.8 Assessment of Test Results

The results from field infiltration methods should be examined to consider data variability and sample distribution to determine if there has been adequate sampling. If the spatial variability (heterogeneity) is large, then additional field measurements may be necessary. The infiltration results should be compared to the information gathered on site soils and geology to see if they are consistent. The results of the site soils and infiltration testing may then be used in the siting, selection, sizing, and design of LID site design techniques and structural treatment BMPs.

C.9 References

ASTM D 3385-94, 2003. "Standard Test Method for Infiltration Rate of Soils Field Using Double-Ring Infiltrometer." American Society for Testing Materials, Conshohocken, PA. 10 Jun, 2003.

Braga, A.M., R. L. Fitsik, 2008. "LID Performance Monitoring Challenges and Results for Infiltrating BMPs: Bioretention Cells, Raingardens, and Porous Pavements". Proceedings for the

California Department of Water Resources, Southern District (DWR), 1961, "Planned Utilization of the Ground Water Basins of the Coastal Plain of Los Angeles County, Appendix A Ground Water Geology". Bulletin No. 104.

Caltrans, 2003. "Infiltration Basin Site Selection". Study Volume I. California Department of Transportation. Report No. CTSW-RT-03-025.

Group Delta Consultants Inc., 2008. "Geotechnical Investigation Feasibility for Surface Water Infiltration San Gabriel Elementary School. South Gate, California" October 3, 2008.

Natural Resources Conservation Service (NRCS), 2003. "Field Indicators of Hydric Soils in the United States Guide for Identifying and Delineating Hydric Soils", Version 5.01, United States Department of Agriculture. 2003

Soil Moisture Equipment Corp. 2005. Operating Instructions Model 2800K1 Guelph Permeameter. Santa Barbara, CA. www.soilmoisture.com.

United States Environmental Protection Agency (USEPA). 1994. Potential Groundwater Contamination from Intentional and Non-Intentional Stormwater Infiltration, Report No. EPA/600/R-94/051.

United States Department of Agriculture (USDA), 2005. "Water Movement in Soils - June 2005" website of Jay Jabro. <http://fs-sdy2.sidney.ars.usda.gov/stationgallery/jayjabro/index.html>

United States Department of the Interior, Bureau of Reclamation (USBR), 1990a, "Procedure for Performing Field Permeability Testing by the Well Permeameter Method (USBR 7300-89)," in Earth Manual, Part 2, A Water Resources Technical Publication, 3rd ed., Bureau of Reclamation, Denver, Colo.

Yerkes et al, 1965, "Geology, Los Angeles, California – An Introduction". Geological Survey Professional Paper, 420-A.

APPENDIX D: BMP SELECTION AND COMBINED LID/TREATMENT BMP SIZING GUIDANCE

D.1 BMP Selection Guidance

Summary of Permit BMP Performance Standards and Selection Criteria

The following BMP performance standards and selection criteria are located in Part 3 – Storm Water Quality Management Program Implementation, Section A. General Requirements, subsection 3 of [Order 09-0057](#) (page 33 of 120 [Final – Corrected 1/13/10]):

“Each Permittee shall require that treatment control BMPs being implemented under the provisions of this Order shall be designed, at a minimum, to achieve the BMP performance criteria for storm water pollutants likely to be discharged as identified in Attachment “C”, for an 85th percentile 24-hour runoff event determined as the maximized capture storm water volume for the area using a 48 to 72-hour draw down time, from the formula recommended in Urban Runoff Quality Management, WEF Manual of Practice No. 23/ASCE Manual of Practice No. 87, (1998). Expected BMP pollutant removal performance for effluent quality was developed from the WERF ASCE/U.S. EPA International BMP Database. Permittees shall select Treatment BMPs based on the primary class of pollutants likely to be discharged from the site/facility (e.g. metals from an auto repair shop). Permittees may develop guidance for appropriate Treatment BMPs for project type based on Attachment “C”. For the treatment of pollutants causing impairments within the drainage of the impaired waterbody, permittees shall select BMPs from the top three performing BMP categories or alternative BMPs that are designed to meet or exceed the performance of the highest performing BMP for the pollutant causing impairment.”

Part 4 – Special Provisions (Baseline), Section E. Planning and Land Development Program, subsection I.1.(f) of [Order 09-0057](#) (page 50 of 120 [Final – Corrected 1/13/10]) also contains BMP selection criteria:

“(f) Prioritize the selection of BMPs suites to remove storm water pollutants, reduce storm water runoff volume, and beneficially reuse storm water to support an integrated approach to protecting water quality and managing water resources in the following order of preference:

- (1) Infiltration BMPs*
- (2) BMPs that store and reuse storm water runoff*
- (3) BMPs that incorporate vegetation to promote pollutant removal and runoff volume reduction and integrate multiple uses*

- (4) *BMPs which percolate runoff through engineered soil and allow it to discharge downstream slowly*
- (5) *Approved modular/ proprietary treatment control BMPs that are based on LID concepts and that meet pollution removal goals”*

The two sets of BMP selection criteria listed above are somewhat conflicting. In addition, not all potential BMP types or pollutants of concern are represented in Attachment C. While the [ASCE International BMP Database](#) is a comprehensive source of BMP performance data, effluent concentration summary statistics alone should not be used to select stormwater BMPs, as there are several other considerations and metrics that can be used to compare the performance of BMPs for the pollutants of concern. These considerations are discussed below.

Using Performance Statistics for BMP Selection

The observed performance of stormwater BMPs provides valuable quantitative information that can be used to infer the potential water quality benefits of stormwater BMP implementation. However, water quality data sets and the statistical methods used to summarize them inherently contain a high level of uncertainty. Consideration of this uncertainty is fundamental to the proper and responsible use of statistics. Some of the key issues that should be considered when drawing conclusions from data contained in the [ASCE International BMP Database](#) for the purposes of developing BMP selection guidance are discussed below.

Number of Representative BMPs

Some BMP types are not well represented in the [ASCE International BMP Database](#) due to small data sets. For example, the “Wetland Basin” category only included nine studies nationwide as compared to over 50 for biofilters at the time the data analysis was conducted for the MS4 permit (2007). For some pollutants, such as total copper, data are only available for four Wetland Basin studies. While the BMP Database continues to grow, there are currently less than 300 BMP studies included, with only approximately 50 in California. The size of the data set provides an indicator of the reliability of that data in representing the “typical” effluent concentration for that BMP type.

BMP Categorization

The BMP studies within the BMP database represent a wide spectrum of BMP types with a variety of designs and sizing criteria. While some guidance is provided on how to categorize BMPs, data providers are responsible for categorizing their own BMPs. Some of these BMPs could be poorly categorized due to a variety of reasons, such as differences in terminology, missing or inadequately sized treatment components (e.g., forebays, vegetation, or permanent pools) or variable treatment function (e.g., a seasonal wet pond). Ideally, the BMPs should be grouped according to common design components and/or sizing criteria, but there currently aren’t enough data with

design information to support such analyses. However, the BMP Database is currently undergoing a restructuring that is redefining or sub-categorizing the current BMP categories within the database.

Statistical Significant Difference between BMP Influent/Effluent

Some of the median effluent values reported in the BMP Database are not statistically different than the median influent values (i.e., no concentration reductions on average). No significant difference may indicate either low influent concentrations or poor performing BMPs for that pollutant. In either case, the effluent value alone would not be a reliable indicator of BMP performance. For example, as summarized in Geosyntec and Wright Water (2008), the data for Wetland Basins, a “top performing” BMP according to Attachment C of the MS4 permit, did not conclusively show statistically significant removals of TSS, nitrate-nitrogen, or total lead. Data for hydrodynamic separators and media filters indicate they are also ineffective at reducing nitrate-nitrogen concentrations. Table D-1 below summarizes the BMPs with and without statistically significant removal of selected pollutants based on 2007 summary statistics provided in Geosyntec and Wright Water (2008).

Table D-1: Summary of BMPs with Statistically Significant Removal of Selected Pollutants

BMP Category	Total Suspended Solids	Total Nitrate-Nitrogen	Total Copper	Total Lead	Total Zinc
Detention Pond	Maybe	Maybe	No	No	Yes
Wet Pond	Yes	Yes	Yes	Yes	Yes
Wetland Basin	Maybe	Maybe	Yes	Maybe	Yes
Biofilter	Yes	Yes	Yes	Maybe	Yes
Media Filter	Yes	No	Yes	Yes	Yes
Hydrodynamic Device	Maybe	No	No	Maybe	Yes

“Yes” indicates that the median of each individual BMP’s average effluent EMC and the median of all combined effluent EMCs were statistically significantly different from the influent medians.

“No” indicates that the median of each individual BMP’s average effluent EMC and the median of all combined effluent EMCs were not statistically significantly different from the influent medians. “Maybe” indicates that one of these medians (each individual BMP or the combined EMC for all BMPs in the category) is statistically different than influent median and the other is not statistically different than the influent median. Therefore, the data are inconclusive.

Statistical Significant Differences in Effluent between BMP Types

The median effluent concentrations of the various BMP types are not necessarily statistically significantly different from each other. Statistical significance can be determined by analyzing whether the 95th percent confidence intervals overlap. The number of data points and the variability of those data points determine the confidence interval of each median value. If the effluent medians are not statistically significantly different from each other, it may not be possible to determine the “top three” performing BMPs as specified in the MS4 Permit. Confidence intervals about the median effluent concentrations for each BMP type are provided in Geosyntec and Wright Water (2008).

Based on median effluent concentrations provided in Attachment C of the MS4 Permit, the top three BMPs for each constituent are:

Total Suspended Solids: Wet Pond > Media Filter > Wetland Basin

Nitrate-Nitrogen: Wetland Basin > Wet Pond > Hydrodynamic Device

Total Copper: Wetland Basin > Wet Pond > Media Filter

Total Lead: Wetland Basin > Media Filter > Wet Pond

Total Zinc: Wet Pond > Biofilter > Wetland Basin

However, if the confidence intervals about the median effluent EMC as summarized in Geosyntec and Wright Water (2008) and only BMPs with statistically significant removal (“Yes” in Table D-1 above) or potentially statistically significant removal (“Maybe” in Table D-1 above) are considered, then the following “top” BMPs emerge (note there are several “ties” due to overlapping median confidence intervals):

Total Suspended Solids: Wet Pond \cong Media Filter \cong Biofilter \cong Wetland Basin

Nitrate-Nitrogen: Wet Pond \cong Biofilter \cong Wetland Basin

Total Copper: Wetland Basin > Wet Pond \cong Media Filter

Total Lead: Wetland Basin > Media Filter \cong Biofilter \cong Wet Pond

Total Zinc: Wet Pond \cong Media Filter \cong Wetland Basin \cong Biofilter

As indicated above, when considering influent concentrations and statistical significance between data sets, the data contained in the [ASCE International BMP Database](#) indicate that wet ponds, wetland basins, media filters and biofilters are among the best performing for the listed pollutants. This conclusion is consistent with the treatment processes typically provided by these BMP types (e.g., filtration, sedimentation, adsorption, and biological processes). Statistically significant removal of nitrate was observed for wet ponds and biofilters. However, given the unit processes necessary to remove nitrate from surface water (i.e., denitrification and

plant uptake) and those likely provided by these BMPs (some plant uptake, but dependent on many factors such as vegetation density, contact time, and nutrient demands), only limited removal would be expected in wet ponds and biofilters, depending on the specific design components (e.g., wetland features integrated into a wet pond would harness some nitrate removal processes). Hydrodynamic separators are clearly not a “top” BMP for the removal of nitrate, despite the low median effluent quality reported by the BMP Database, as hydrodynamic separators are designed to remove sediment, trash, and debris and don’t provide a treatment process that addresses nitrate-nitrogen, a dissolved phase constituent.

Wet ponds and wetland basins are attractive solutions both from a treatment process and observed performance perspective. However, these systems require significant base flow to maintain their permanent pools and to avoid creating stagnant conditions and vector concerns, so these BMPs are often infeasible in locations where water conservation during dry weather is a significant concern. If a regional stormwater treatment system is desired, infiltration basins and extended dry detention basins are typically more feasible in Ventura County. However, these may need additional treatment system components in a treatment train (e.g., pre- or post-treatment) to adequately address the entire list of pollutants of concern and provide reliable and consistent performance, in addition to significant space requirements. BMP designs for each category that incorporate dense vegetation and promote extended contact with or filtration through soils are encouraged, consistent with the BMP selection prioritization requirements in [Order 09-0057](#).

Using Fundamental Treatment Processes as the Basis of BMP Selection

Based on the discussion above, use of median effluent concentrations from the BMP Database as the sole indicator of relative BMP performance would not be reliable and could lead to incorrect specification of the best performing BMPs for a particular pollutant (e.g., hydrodynamic device for nitrate removal). Even with the consideration of the number of BMP studies and statistically significant differences, data from the BMP Database can only provide a partial indication of relative performance.

The other piece of relevant information that should be considered during BMP selection is the fundamental treatment processes required to remove each pollutant of concern. BMPs should then be selected that specifically provide those unit processes. This approach is consistent with the second set of BMP selection criteria contained in Part 4 of the MS4 Permit, which states that BMPs should be selected “to remove storm water pollutants, reduce storm water runoff volume, and beneficially reuse storm water.”

The Water Environment Research Foundation (WERF) report titled “[Critical Assessment of Stormwater Treatment and Control Selection Issues](#)” (Strecker et al., 2005) provides a detailed step-by-step approach to identifying water quality objectives, the treatment processes available to meet those objectives, and the BMP

components needed to provide those treatment processes. The WERF report describes four fundamental process categories: 1) hydrologic operations, 2) physical operations, 3) biological processes, and 4) chemical processes. Hydrologic operations are essentially a subset of physical operations and include the principles of flow attenuation (e.g., peak shaving, detention) and volume reduction (e.g., infiltration, evapotranspiration, rainwater harvesting and use). Physical operations, as referred to herein, include the principles of size separation and exclusion (e.g., screening, filtration), density separation (e.g., sedimentation, flotation), aeration and volatilization, and physical agent disinfection (e.g., ultra-violet light; heat). Biological processes include the principles of microbially-mediated transformations (e.g., redox reactions resulting from microbial respiration) and uptake and storage (e.g., bioassimilation). Chemical processes include the principles of sorption (e.g., ion exchange, surface complexation), coagulation and flocculation (e.g., particle agglomeration; precipitation), and chemical agent disinfection (e.g., chlorine, ozone). The selection of any one of these treatment processes should be based on the nature of the target pollutants in relation to specific stormwater management goals. Table D-2 below relates target pollutants and treatment processes to specific BMP components.

After the appropriate and necessary BMP components are selected for a site, candidate BMP treatment systems can be conceptualized using a treatment train-based approach:

- 1) Minimize flow rates and/or volume of runoff from the project site (hydrologic source control).
- 2) Remove bulk solids (pretreatment: > 5mm)
- 3) Remove settleable solids and liquid floatables (coarse primary conventional treatment: >75 μm ; fine primary conventional treatment: >10 μm)
- 4) Remove suspended and colloidal solids (secondary conventional treatment: > 0.1-25 μm)
- 5) Remove colloidal, dissolved, volatile, and pathogenic pollutants (enhanced treatment)

Table D-2: BMP Categories Recommended for Addressing Pollutants of Concern

Category	Applicable Removal Processes	Recommended BMP Categories
Particulate Bound Pollutants	Hydrologic operations (volume reduction) Physical operations(sorption, size separation, density/gravity separation)	LID/volume reduction BMPs (infiltration, evapotranspiration, capture/reuse) Wetponds/Detention Bioretention / biofiltration Media filtration
Metals / Metalloids	Hydrologic operations (volume reduction) Physical operations(sorption, density separation) Biological processes (microbially mediated transformations, uptake and storage)	LID/volume reduction BMPs (infiltration, evapotranspiration, capture/reuse) Wetponds/Wetlands/Detention Bioretention / biofiltration Media filtration Bioreactors (subsurface flow wetlands)
Nutrients	Hydrologic operations (volume reduction) Biological processes (microbially mediated transformations, uptake and storage)	LID/volume reduction BMPs (infiltration, evapotranspiration, capture/reuse) Wetponds/Wetlands Bioretention Bioreactors (subsurface flow wetlands)
Other Organics	Hydrologic operations (volume reduction) Physical operations(aeration and volatilization) Chemical processes(chemical sorption)	Sediment source controls, erosion controls LID/volume reduction BMPs (evapotranspiration, capture/reuse)
Pathogens	Physical operations(physical agent disinfection) Chemical processes(chemical disinfection)	LID/volume reduction BMPs (infiltration, evapotranspiration, capture/reuse) Bioretention / biofiltration Media filtration Advanced treatment systems / treatment plants
Pesticides	Chemical processes	Sediment source controls, erosion controls Advanced treatment system / treatment plants
Salinity	Physical processes	Advanced treatment system / treatment plants (e.g., reverse osmosis)
Sediment	Sedimentation/Siltation	LID/volume reduction BMPs (infiltration, evapotranspiration, capture/reuse) Wetponds/wetlands, detention Bioretention / biofiltration Media filtration
Toxicity	Chemical processes	Sediment source controls, erosion controls Advanced treatment system / treatment plants

D.2 Combined LID/Treatment BMP Sizing Guidance

The Ventura Countywide MS4 Permit contains requirements to implement Low Impact Development (LID) and treatment control BMPs for applicable new development and redevelopment projects. These requirements overlap significantly and some management practices may fulfill both requirements. This appendix describes the performance standards for LID and treatment control BMPs from the permit and proposes a methodology for implementing these standards.

New Development and Redevelopment Permit Requirements for LID and Treatment Control

Integrated Water Quality/Flow Reduction/Resources Management Criteria identified in the Ventura Countywide MS4 Permit require that the “effective impervious area” be reduced to less than or equal to 5 percent, or less than or equal to 30 percent where infeasible to achieve 5 percent EIA, **through infiltration, storage for reuse, evapotranspiration or bioretention/biofiltration.** Impervious surfaces may be rendered “ineffective,” and thus not count toward the EIA limitation, if the stormwater runoff from those surfaces is fully retained on-site for a specified design storm event. Design storm alternatives for mitigating EIA include methods (1) through (3) below.

The permit also states that volume-based treatment control BMPs shall be designed to mitigate (infiltrate or treat) stormwater runoff from either:

- (1) The 85th percentile 24-hour runoff event determined as the maximized capture stormwater volume for the area using a 48 to 72-hour draw down time, from the formula recommended in Urban Runoff Quality Management, WEF Manual of Practice No. 23/ASCE Manual of Practice No. 87, (1998);
- (2) The volume of annual runoff based on unit basin storage water quality volume, to achieve 80 percent or more volume treatment by the method recommended in the Ventura County Technical Guidance Manual for Storm Water Quality Control Measures (July 2002 and its revisions); or
- (3) The volume of runoff produced from a 0.75 inch storm event.

Three additional permit requirements are relevant:

- The third volumetric sizing option (the volume of runoff produced from a 0.75 inch storm event) may be used for the mitigation of EIA for all projects, but it may not be used for treatment control BMP sizing for projects larger than 5 acres.
- For projects larger than 50 acres, the applicable treatment control BMP standard is treatment of eighty percent of the average runoff volume, determined using an appropriate public domain continuous flow model with the local rainfall record.

- Projects must treat all remaining runoff pursuant to the treatment control BMP sizing requirements.

Drawdown time is not stated in sizing alternative (3) above. While a maximum drawdown time of 48 to 72 hours is generally implied in treatment control BMP design, it may not be feasible to draw down retention BMPs this quickly. For example, cisterns with relatively low demand may draw down over weeks rather than days. Such a system would still fulfill minimum EIA mitigation requirements, but could result in lower average annual capture efficiency than would be required to fulfill minimum treatment control BMP requirements for projects greater than 5 acres.¹

Cases may therefore exist where the BMP volume required to mitigate EIA may be less than required to fulfill treatment control requirements. In these cases, the performance standard presented below considers both requirements, and a methodology is provided to select and size a combination of LID and treatment control BMPs that meets this combined performance standard.

Combined LID and Treatment Control Performance Standard

The following can be used as a combined performance standard:

One of the three options below must be met to comply with LID and treatment control requirements for new development and redevelopment:

- 1) *BMPs must be sized to retain (infiltrate, reuse, or evapotranspire) 80 percent of average annual runoff volume from the entire site.*

OR

- 2) *BMPs must be sized to:*

- a. *retain (infiltrate, reuse, or evapotranspire), at a minimum, the runoff volume from a 0.75 inch storm over the impervious areas of the project, minus the runoff volume from 5 percent EIA, and*
- b. *meet all applicable treatment control requirements in addition to those met through (2a)*

OR

- 3) *BMPs must be sized to:*

¹ Sizing option (1) achieves approximately 80 percent average annual runoff capture when BMPs draw down over approximately 48-72 hours (or more quickly). Sizing option (2) and the applicable provision for projects > 50 acres both ensure 80 percent capture.

- a. *retain (infiltrate, reuse, or evapotranspire), at a minimum, the runoff volume from a 0.75 inch storm over impervious areas of the project, minus the runoff from up to 30 percent EIA, and*
- b. *meet all applicable treatment control requirements in addition to those met through (3a), and*
- c. *fulfill all applicable obligations for alternative compliance for the difference between the volume retained and runoff volume from the 0.75 inch storm computed based on 5 percent EIA.*

Approaches for Implementing the Combined Performance Standard

This section describes approaches for implementing the combined performance standard described above. For the purpose of this section, the following terms are used:

Percent EIA = percent of the project site that functions as directly connected impervious area. Note this is *not* the percentage of the *impervious area* of the project, but the percentage of the *entire project*.

V_{LID} = the required retention volume from a 0.75 inch storm to achieve 5 percent EIA.

$V_{LID\ ALT\ MIN}$ = the required retention volume from a 0.75 inch storm to achieve 30 percent EIA.

$V_{LID\ ALT}$ = the retention volume from a 0.75 inch storm to achieve between 5 percent and 30 percent EIA. $V_{LID\ ALT}$ must be as close to V_{LID} as feasible and not less than $V_{LID\ ALT\ MIN}$.

Five approaches are outlined below for achieving compliance with the combined LID and treatment control performance standards:

Approach 1. Projects Less than 5 Acres

Provide retention of V_{LID} if feasible, and no less than $V_{LID\ ALT}$. Design retention volume to draw down as quickly as possible. Provide treatment control BMPs to address pollutants of concern for the EIA that is not mitigated. Fulfill alternative compliance requirements for $V_{LID} - V_{LID\ ALT}$.

Approach 2. Projects Greater than 5 acres using Infiltration BMPs – Option A

Size infiltration BMPs for one of the preselected combinations of design storm and drawdown time prescribed in Table D-3.

Table D-3: Preselected BMP Sizing Configurations to Achieve 80 percent retention

Drawdown Time, hours	Design Storm Depth, inches ¹
12	0.75
24	1.0
48	1.4
72	1.7

¹ Resulting capture efficiencies are expected to range from approximately 75 percent to 85 percent across the County.

Approach 3. Projects Greater than 5 acres using Infiltration BMPs – Option B

Provide infiltration BMP to retain V_{LID} if feasible and no less than $V_{LID\,ALT}$. Design the retention component to draw down as quickly as possible. Provide treatment (with discharge) to address pollutants of concern for remaining runoff up to 80 percent capture using design nomographs.

Approach 4. Projects Greater than 5 acres using Rainwater Harvesting for Outdoor Demand

Provide cistern sized for V_{LID} if feasible and no less than $V_{LID\,ALT}$. Design the cistern to draw down as quickly as possible. Provide treatment (with discharge) to address pollutants of concern for remaining runoff up to 80 percent capture using Figures D-1 and D-3, or Figures D-2 and D-4.

Approach 5. All Projects, All BMP Types

Project-specific analysis using acceptable methods to demonstrate compliance with performance standards.

Supporting Tools for Approaches 3 and 4

Approaches 3 and 4 consist of two steps: (1) estimate the capture efficiency that would result from meeting LID provisions, and (2) determine the additional treatment that would be required to meet water quality treatment control requirements. Two sets of nomographs would support the application of these options:

- *Constant Drawdown Nomographs.* Figures D-1 and D-2 provide relationships between drawdown time, design storm depth, and capture efficiency. These can be used to estimate the capture efficiency from any BMP that draws down at a relatively constant rate regardless of the time of year.
- *Seasonally-Varying Demand Nomographs.* Figures D-3 and D-4 provide relationships between irrigated area, design storm depth and capture efficiency. These can be used to estimate the capture efficiency of typical cistern configurations which would have seasonally-varying drawdown pattern (influenced by rainfall and evapotranspiration rates).

These nomographs are based on continuous simulation performed in EPA SWMM using precipitation and ET records representative of lowland regions (Oxnard Airport Precipitation Gauge, El Rio Spreading Grounds ET station) and mountainous regions (Ojai-Stewart Canyon Precipitation Gauge, Matilja ET Station) of the County.

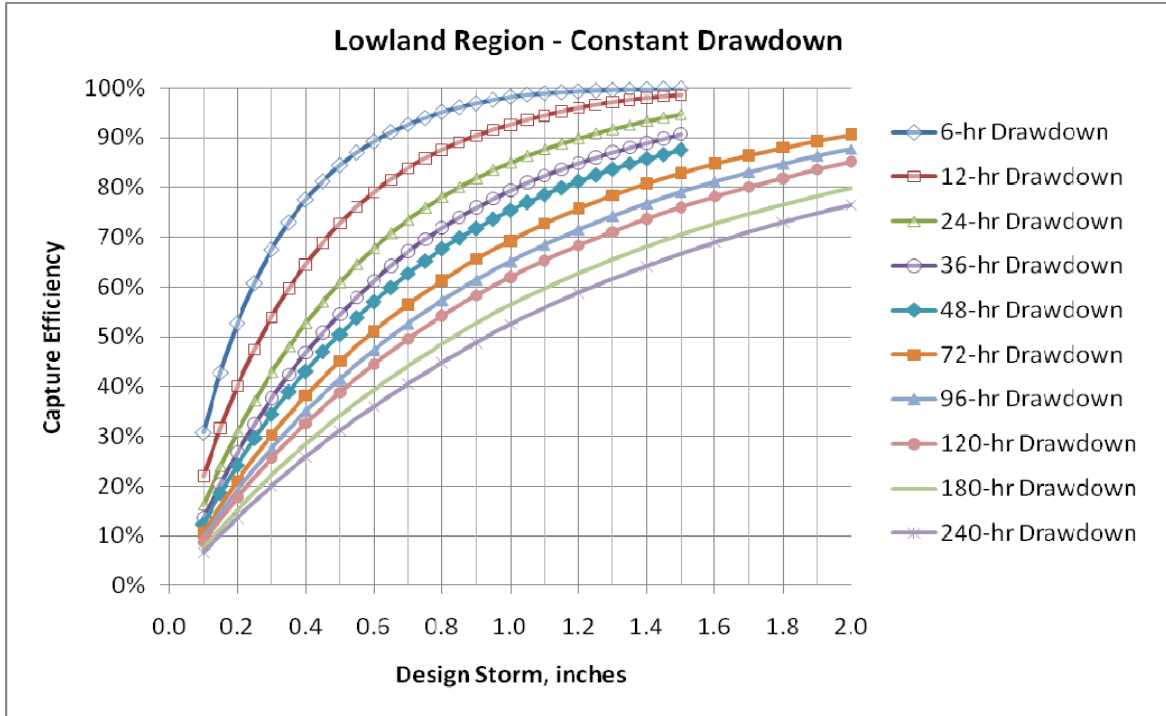


Figure D-1: Percent capture nomograph for systems with constant drawdown lowland regions of Ventura County

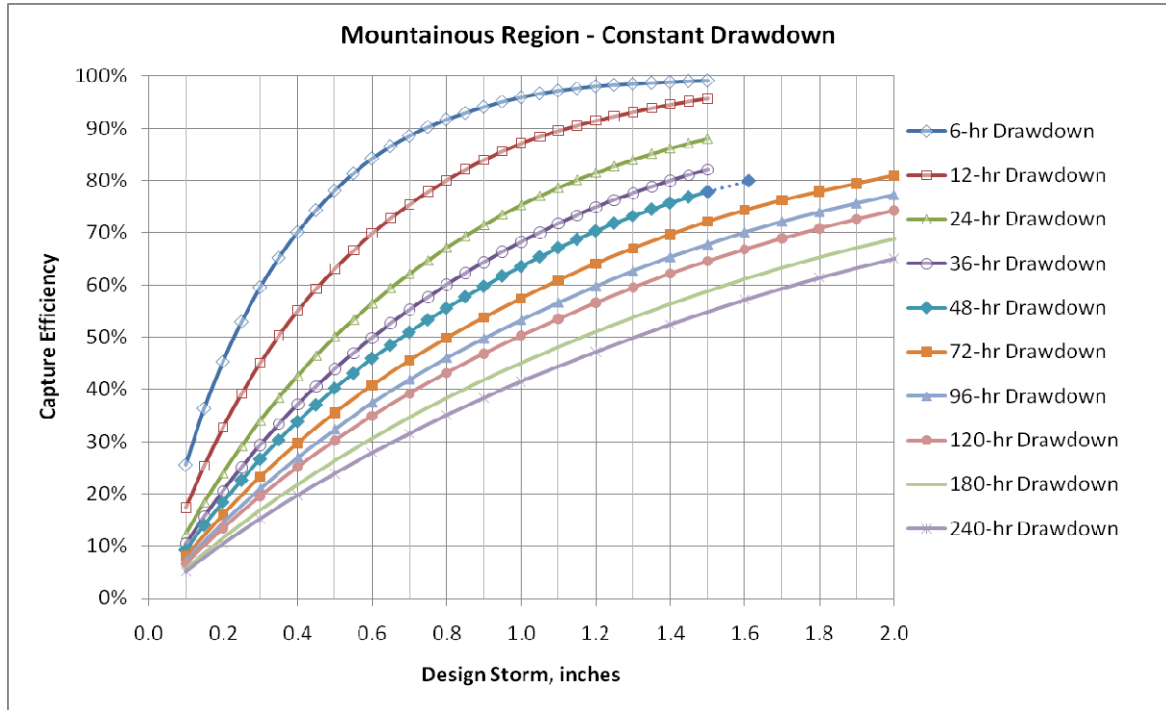


Figure D-2: Percent capture nomograph for systems with constant drawdown in mountainous regions of Ventura County

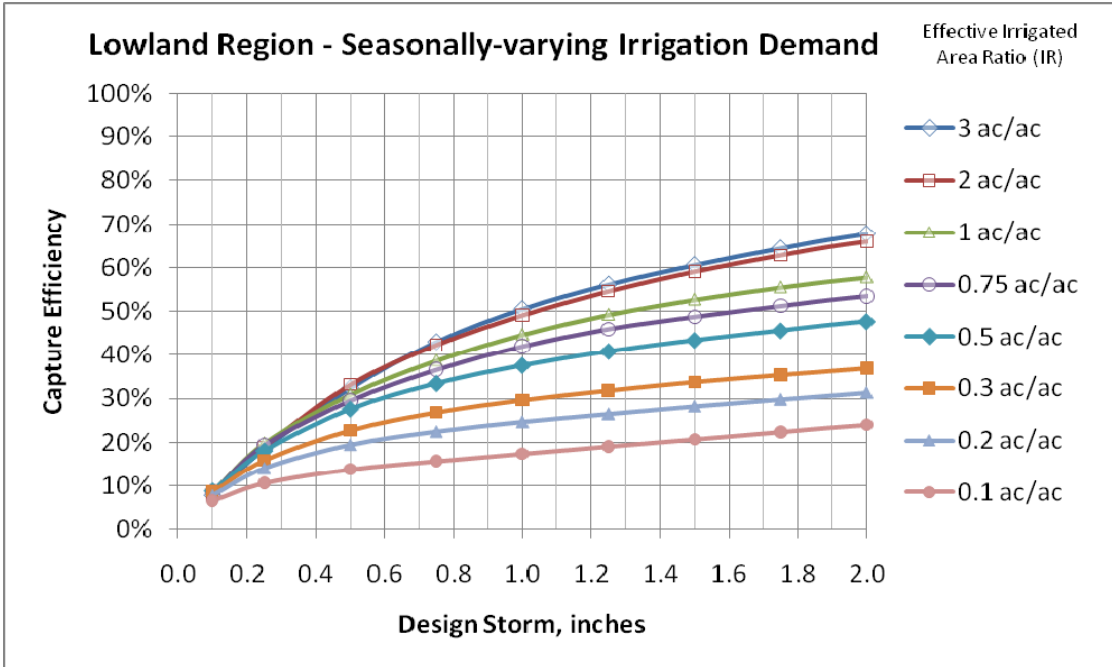


Figure D-3: Percent capture nomograph for systems with seasonally-varying demand in lowland regions of Ventura County

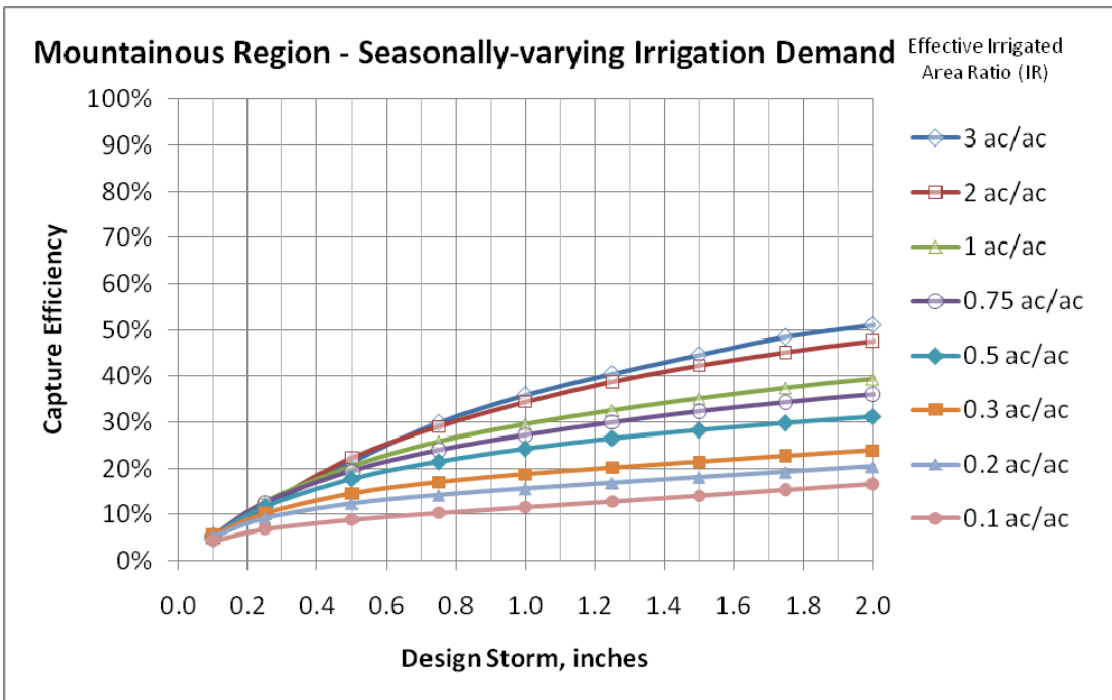


Figure D-4: Percent capture nomograph for systems with seasonally-varying demand in mountainous regions of Ventura County

Example Application of Approach 3

A conceptual example application of Approach 3 is provided. In this example, soil infiltration rates are low and V_{LID} cannot be drawn down in close to 12 hours. This configuration results in less than 80 percent capture, therefore another BMP is provided to meet water quality treatment requirements for the remaining volume up to 80 percent capture.

Given:

- Lowland region of the County
- Infiltration BMP sized for V_{LID} , drawing down over 72 hours. In this example, assume that V_{LID} equates to a 0.7 inch design storm over the entire site.
- Additional treatment to be provided in bioretention area with underdrains drawing down over 6 hours.

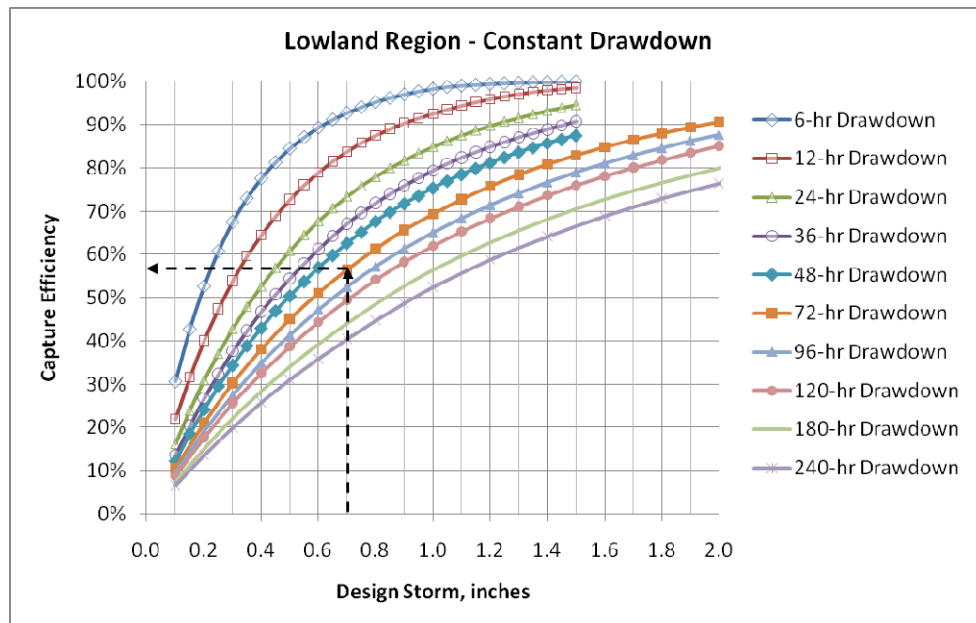
Required:

- What volume needs to be provided in the bioretention area with underdrains in order to result in 80 percent overall capture efficiency (including the benefits of the infiltration BMP)?

Solution:

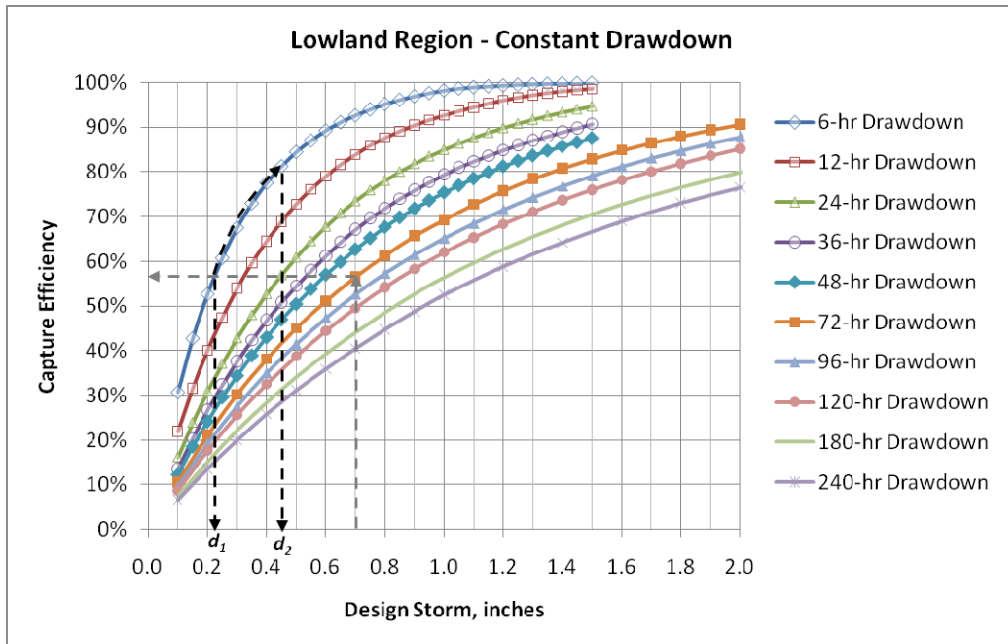
- 1) Use the nomograph for constant drawdown in lowland regions of the County.
- 2) Read the V_{LID} design storm from the horizontal axis (**0.7 inches**) and trace a vertical line to the line representing the drawdown time of the infiltration BMP (**72 hours**).
- 3) Pivot on the line and read directly to the vertical axis to estimate the capture efficiency: **57 percent capture**. This means that 57 percent of average annual runoff volume would be infiltrated and not discharged to surface conveyance.

Graphical operations described in Steps 1 to 3:



- 4) Follow the horizontal line traced on the nomograph in step (3) to where it intersects with the line representing the biotreatment/biofiltration drawdown time selected, in this case **6 hours**.
- 5) Read down to the horizontal axis to the design storm depth (d_1): **0.22 inches**.
- 6) Follow the selected drawdown line upward and to the right until it intersects with 80 percent capture.
- 7) Read down to the horizontal axis to the design storm depth (d_2): **0.46 inches**.
- 8) Compute the difference between d_2 and d_1 : **0.24 inches**. This is the additional volume required in the bioretention area with underdrains to achieve 80 percent capture.

Graphical operations described in Steps 4 to 8:



APPENDIX E : BMP SIZING WORKSHEETS

E.1 Structural Treatment BMP Sizing Criteria

The BMP sizing criteria for determining the design volume or design flow for a proposed BMP are discussed in this appendix. These criteria must be used for all stormwater BMPs installed in new and re-development projects in Ventura County. This section outlines the rainfall analyses, Ventura County MS4 Permit sizing criteria, and recommended sizing methods for both volumetric and flow-based analysis.

Sizing Criteria



The type of rainfall analysis required depends on whether the BMP is a volume-based or flow-based BMP. This distinction between volume-based and flow-based controls is not always clear, especially in a sequence of BMPs or a treatment train. The following are general guidelines for each type of control.

- Volume-based BMPs are designed to treat a volume of runoff, which is detained for a certain period of time to allow for the settling of solids and associated pollutants. Volume-based BMPs included in this manual are bioretention, planter boxes, infiltration systems, and retention/detention BMPs.
- Flow-based BMPs treat water on a continuous flow basis. Flow-based BMPs included in this manual are vegetated swales, filter strips, filtration systems, and hydrodynamic devices.

The four volume-based and three flow-based BMP sizing criteria included in the Ventura County MS4 Permit (Order No. 09-0057) are included below.

The water quality design volume for volume-based BMPs must be determined using one of the following options:

- 1) The 85th percentile 24-hour runoff event determined as the maximized capture stormwater volume for the area using a 48 to 72-hour draw down time, from the formula recommended in Urban Runoff Quality Management, WEF Manual of Practice No. 23/ASCE Manual of Practice No. 87, (1998); or
- 2) The volume of annual runoff based on unit basin storage water quality volume to achieve 80 percent or more volume treatment; or
- 3) The volume of runoff produced from a 0.75 inch storm event; or
- 4) 80 percent of the average runoff volume using an appropriate public domain continuous flow model [such as Storm Water Management Model (SWMM) or Hydrologic Engineering Center – Hydrologic Simulation Program – Fortran (HEC-HSPF)], using the local rainfall record and relevant BMP sizing and design data.

Flow-based BMPs must be designed to capture and treat the water quality design flow rate generated from one of the following criterion:

- 1) The flow of runoff produced from a rain event equal to at least 0.2 inches per hour intensity; or
- 2) The flow of runoff produced from a rain event equal to at least 2 times the 85th percentile hourly rainfall intensity as determined from local rainfall records; or
- 3) Eight percent of the 50-year storm design flow rate as determined from the method provided below.

These sizing methods are explained below.

Methods for Determining the Water Quality Design Volume

Method 1: Urban Runoff Quality Management (URQM) Approach

The volume-based BMP sizing methodology described in Urban Runoff Quality Management (WEF Manual of Practice No. 23/ASCE Manual of Practice No. 87, (1998), pages 175-178) estimates the “maximized stormwater quality capture volume.” The URQM approach is based on the translation of rainfall to runoff using two regression equations. The first regression equation, which relates rainfall to runoff, was developed using two years of data from more than 60 urban watersheds nationwide. The second regression equation relates mean annual runoff-producing rainfall depths to the “Maximized Water Quality Capture Volume” which corresponds to the “knee of the cumulative probability curve”. This second regression was based on analysis of long-term rainfall data from seven rain gages representing climatic zones across the country. The Maximized Water Quality Capture Volume corresponds to approximately the 85th percentile runoff event, and ranges from 82 to 88%.

The two regression equations that form the URQM approach are as follows:

$$C = 0.858imp^3 - 0.78imp^2 + 0.774imp + 0.04 \tag{Equation E-1}$$

$$P_o = (a \cdot C) \cdot P_6 \tag{Equation E-2}$$

Where:

- C = watershed runoff coefficient (unitless)
- imp = watershed impervious ratio which is equal to the percent total imperviousness divided by 100 (ranges from 0 to 1)
- P_o = maximized detention storage volume based on the volume capture ratio as its basis (watershed inches)

- a = regression constant from least-squares analysis (unit less),
a=1.582 and a=1.963 for 24 and 48 hour draw down,
respectively
- P_6 = mean storm precipitation volume (watershed inches)

P_6 can be determined by two ways: Figure 5.3 in Urban Runoff Quality Management, or by performing analysis on local historical rainfall data. To determine the mean precipitation, EPA's Synoptic Rainfall Analysis Program – SYNOP – can be applied (see *Other Rainfall Analysis Methods* below).

The runoff coefficient equation in the URQM approach (Method 1) is not appropriate for the California BMP Handbook approach (Method 2), as Equation E-4 was developed in conjunction with the regression constants used in Method 1.

Method 2: Treatment of 80% or more of the Total Volume

Most water quality facilities are designed to treat only a portion of the runoff from a given site, as it is not economically feasible to capture 100% of the runoff. The percent of runoff treated by a basin is referred to as the “percent capture”. There are a number of methods which allow calculation of the percent capture, including the California Stormwater Quality Association (CASQA) method (recommended by the 2002 Ventura County Manual), and using the EPA Stormwater Management Model (SWMM).

CASQA Method

The California Stormwater Quality Association (CASQA) BMP Handbook method estimates the basin volume to achieve various levels of volume capture (e.g., 80% for this sizing criterion). In the CASQA BMP Handbook New Development and Redevelopment (2003), a proprietary version of the Storage, Treatment, Overflow, Runoff Model (STORM) is used as the basis for the volume-based BMP sizing criteria. The model results are presented as the relationship between “unit basin storage volume” and “% volume capture” of the BMP”, varying with drawdown time and runoff coefficient. Knowing the drawdown time, the runoff coefficient, and the desired percent capture will yield the “unit basin storage volume”. The “unit basin storage volume” can then be used to size the BMP using the following equation (note that “unit basin storage volume” is given in inches, so units will have to be adjusted accordingly):

$$\text{BMP Volume} = \text{Unit Basin Storage Volume} \times \text{Tributary Area} \quad (\text{Equation E-3})$$

Results for several rain gauges are presented in Appendix D of the CASQA BMP Handbook New Development and Redevelopment (CASQA, 2003). Results are provided for a range of runoff coefficients and for 24 hour and 48 hour drawn down times. In order to use the curves provided in Appendix D, it is necessary to know the

runoff coefficient for the area tributary to the BMP, the drawn down time (a.k.a. drain time) of the facility, and the percent capture goal (e.g., 80%).

Drawdown time is the time required to drain a facility that has reached its design capacity; usually expressed in hours. Drain time is important as it is a surrogate for residence time, which affects the particle settling in the basin. Estimates for design drain time vary, and ideally would be determined based on site-specific information on the size, shape, and density or settling velocity of suspended particulates in the runoff. Because this information is generally not available for a specific site, estimates of appropriate ranges for settling time have generally relied on settling column test information reported in the literature.

An important source of drain time information is settling column tests conducted by Grizzard et. al. (1986) as part of the Nationwide Urban Runoff Program (NURP). Grizzard found that settling times of 48 hours resulted in removals of 80% to 90% of total suspended solids (TSS). Rapid initial removal was also observed in stormwater samples with medium (100 to 215 mg/L) and high (721 mg/L) initial TSS concentrations. For example, at settling times of 24 hours, the 80% to 90% removals were already achieved in samples with medium and high initial TSS, whereas only 50% to 60% removal was achieved in those with low initial TSS.

Given the data provided above, a drain time of 36 to 48 hours is recommended for sizing volume-based BMPs. This is also consistent with the recommendation of vector control agencies that structures be designed to drain in less than 72 hours to minimize mosquito breeding.

The rain gauge that is recommended for use for the area permitted by the Ventura county MS4 Permit (Order No. 09-0057) is the Oxnard Equipment Yard Gauge (168), which has a 40 year rainfall record. The graph included in the CASQA handbook can be seen in below

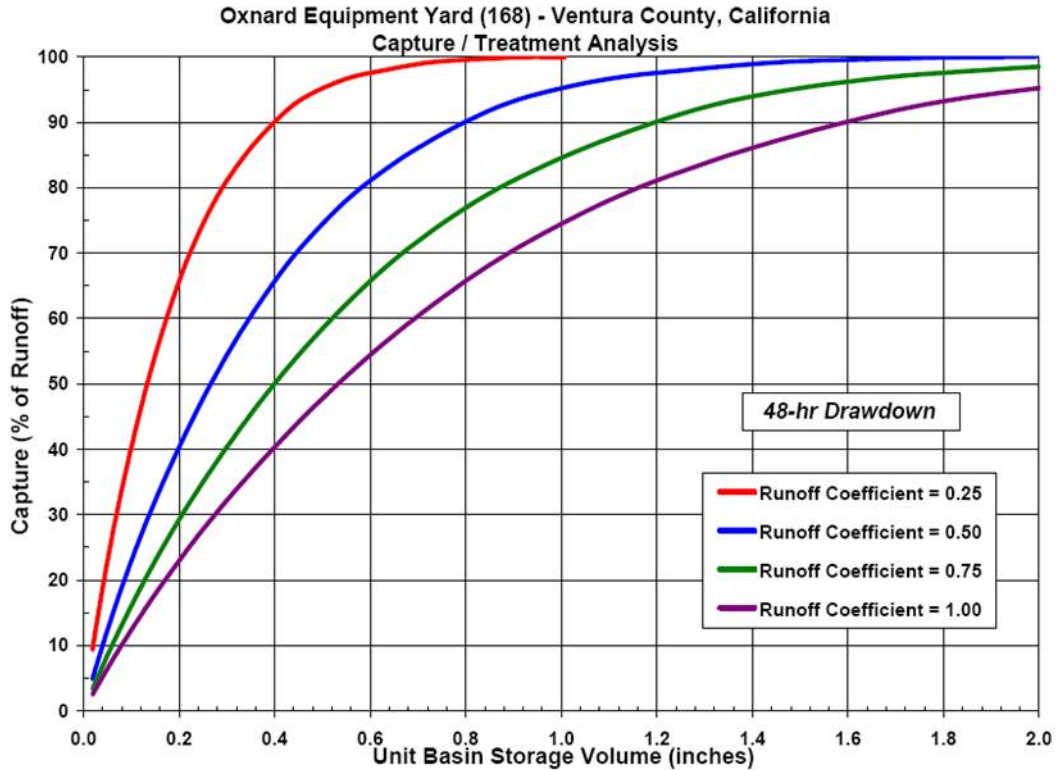


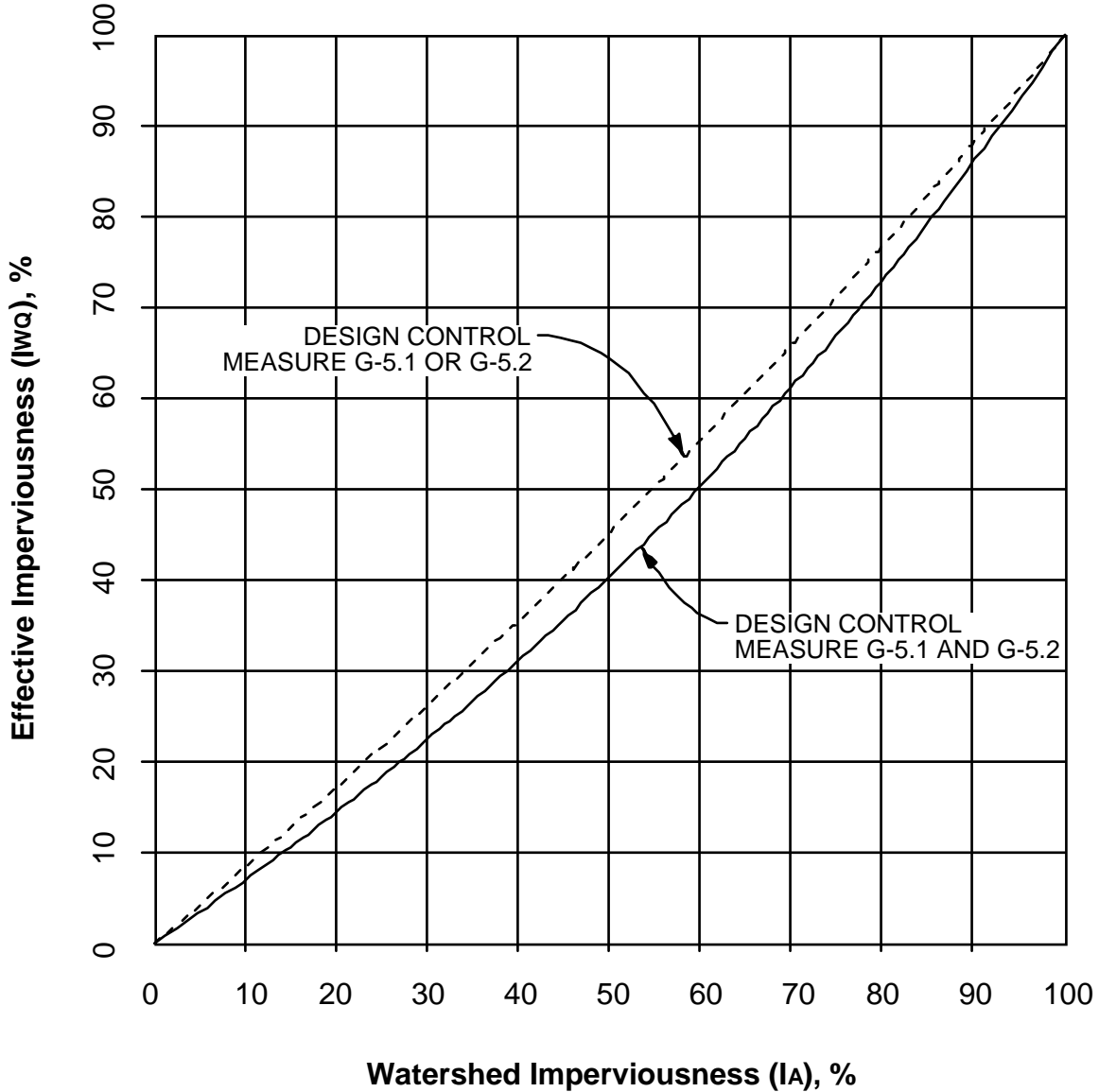
Figure E-1: CASQA 48-hour Drawdown Figure for Oxnard Gauge

This method has been modified for Ventura County. To use this method, follow the calculation procedure below. This refers to Figure E-3.

Ventura County Calculation Procedure

- 1) Review the area draining to the proposed treatment control measure. Determine the effective imperviousness (I_{wQ}) of the drainage area.
- 2) Estimate the total imperviousness (impervious percentage) of the site by the determining the weighted average of individual areas of like imperviousness.
- 3) Enter Figure 3-4 along the horizontal axis with the value of total imperviousness calculated in Step 1. Move vertically up Figure 3-4 until the appropriate curve (G-5.1 or G-5.2 employed individually or G-5.1 and G-5.2 employed together) is intercepted. Move horizontally across Figure 3-4 until the vertical axis is intercepted. Read the Effective Imperviousness value along the vertical axis.
- 4) Note that if G-5.1 and/or G-5.2 are implemented on only a portion of the site, the site may be divided and effective imperviousness determined for the portion of the site for which site design controls have been implemented. The resulting effective imperviousness may be combined with total imperviousness of the

remainder of the site to determine a weighted average total imperviousness for the entire site.



G-5.1: TURF BUFFER
G-5.2: GRASS-LINED CHANNEL

ADAPTED FROM URBAN STORM DRAIN CRITERIA MANUAL
VOL. 3 - BEST MANAGEMENT PRACTICES,
URBAN DRAINAGE AND FLOOD CONTROL DISTRICT, 11/99

Figure E-2: Effective Imperviousness based on Watershed Imperviousness

- 5) Figure 5-1 provides a direct reading of Unit Basin Storage Volumes required for 80% annual capture of runoff for values of “I_{wq}” determined in Step 1. Enter the horizontal axis of Figure 5-1 with the “I_{wq}” value from Step 1. Move vertically up

Figure 5-1 until the appropriate drawdown period line is intercepted. (The design drawdown period specified in the respective Fact Sheet for the proposed treatment control measure.) Move horizontally across Figure 5-1 from this point until the vertical axis is intercepted. Read the Unit Basin Storage Volume along the vertical axis.

- 6) Figure 5-1 is based on Precipitation Gage 168, Oxnard Airport. This gage has a data record of approximately 40 years of hourly readings and is maintained by Ventura County Flood Control District. Figure 5-1 is for use only in the permit area specified in Regional Board Order No. 00-108, NPDES Permit No. CAS004002.
- 7) The SQDV for the proposed treatment control measure is then calculated by multiplying the Unit Basin Storage Volume by the contributing drainage area. Due to the mixed units that result (e.g., acre-inches, acre-feet) it is recommended that the resulting volume be converted to cubic feet for use during design.

Example Stormwater Quality Design Volume Calculation

- 1) Determine the drainage area contributing to control measure, A_t . Example: 10 acres.
- 2) Determine the area of impervious surfaces in the drainage area, A_i . Example: 6.4 acres.
- 3) Calculate the percentage of impervious, $I_A = (A_i / A_t) * 100$

Example:

$$\text{Percent Imperviousness} = (A_i / A_t) * 100 = (6.4 \text{ acres} / 10 \text{ acres}) * 100 = 64\%$$

- 4) Determine Effective Imperviousness using Figure 3-4.
- 5) Determine design drawdown period for proposed control measure.
- 6) Determine the Unit Basin Storage Volume for 80% Annual Capture, V_u using Figure 5-1.

$$\text{For } I_{WQ} / 100 = 0.60 \text{ and drawdown} = 40 \text{ hrs, } V_u = 0.64 \text{ in.}$$

- 7) Calculate the volume of the basin, V_b , where

$$V_b = V_u * A_t \tag{Equation E-4}$$

Where

$$V_b = \text{Volume of basin}$$

V_u = Unit basin storage volume

A_t = Total tributary area

8) $V_b = (0.64 \text{ in})(10 \text{ ac})(\text{ft}/12 \text{ in})(43,560 \text{ ft}^2 / \text{ac}) = 23,232 \text{ ft}^3$.

9) Solution: Size the proposed control measure for 23,232 ft³ and 40-hour drawdown.

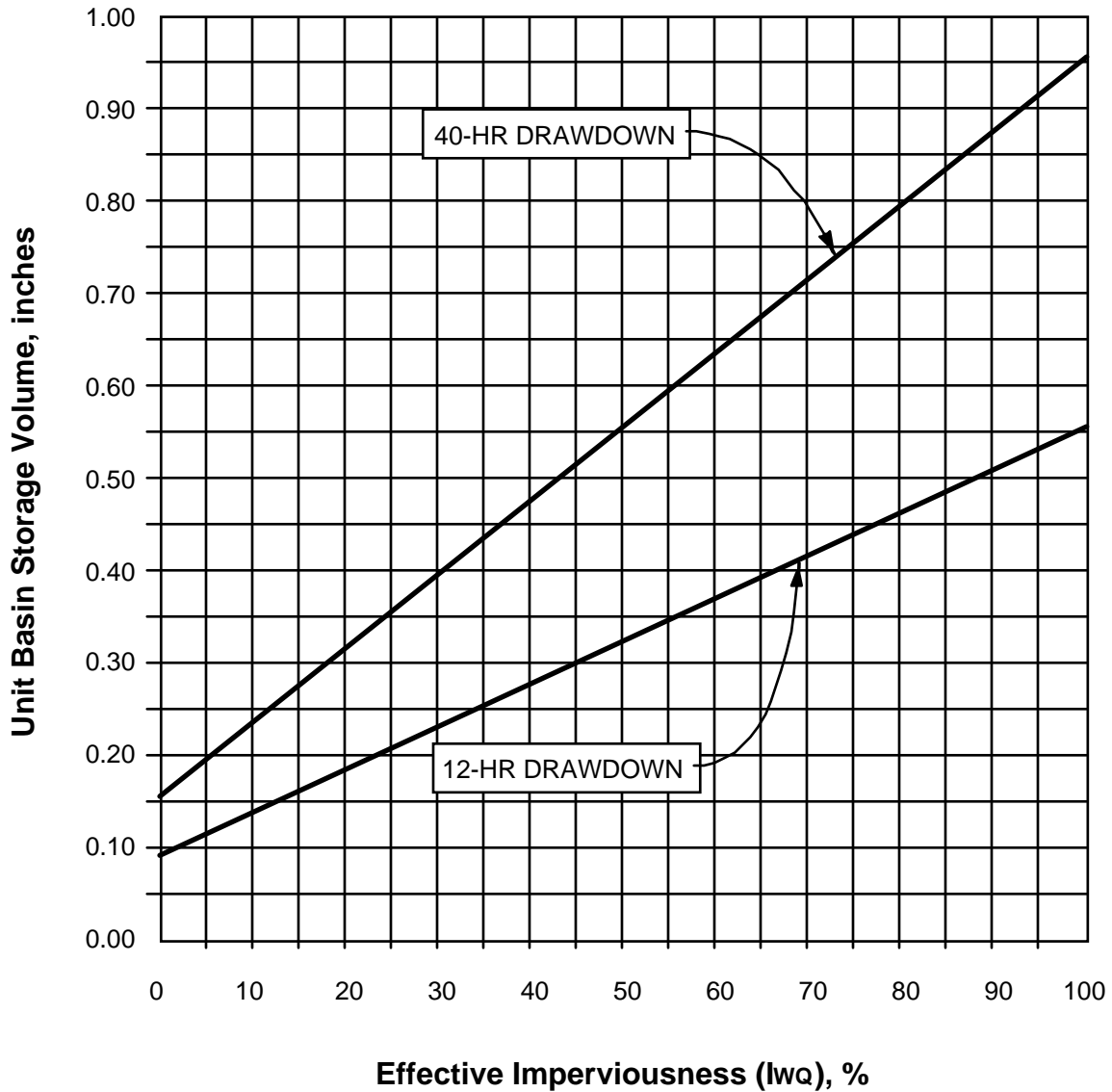


Figure E-3: Unit Basin Storage Volume for Design Volume Method 2

Method 3: 0.75 Inch Design Storm Approach

Error! Reference source not found. can be used to determine the water quality design volume for Method 3.

Calculation Procedure

- 1) Determine the area from which runoff must be retained on-site (A_{retain}) using the method below:

The allowable EIA for a project site can be calculated as follows:

$$EIA_{allowable} = (A_{project}) * (\%_{allowable}) \quad \text{(Equation E-5)}$$

Where:

- $EIA_{allowable}$ = the maximum impervious area from which runoff can be treated and discharged off-site [and not retained on-site] (acres).
- $A_{project}$ = the total project area (acres). “Total project area” for new development and redevelopment projects is defined as the disturbed, developed, and undisturbed portions within the project’s property (or properties) boundary, at the project scale submitted for first approval.
- $\%_{allowable}$ = ranges from 5 percent to 30 percent, based on a project specific assessment of technical feasibility for retaining runoff and whether the project is located in an existing urban area.

The drainage area from which Project generated runoff must be retained on-site is the total impervious area minus the $EIA_{allowable}$, which can be calculated as follows:

$$A_{retain} = TIA - EIA_{allowable} = (P * A_{project}) - EIA_{allowable} \quad \text{(Equation E-6)}$$

Where:

- A_{retain} = the drainage area from which runoff must be retained (acres)
- TIA = total impervious area (acres)
- $EIA_{allowable}$ = the maximum impervious area from which runoff can be treated and discharged off-site [and not retained on-site] (acres).
- P = imperviousness of project area (%) / 100
- $A_{project}$ = the total project area (acres)

Calculation Procedure

- 1) Determine the area from which runoff must be retained on-site (A_{retain}) using method above.
- 2) Determine the runoff coefficient per the following method:

$$C = 0.95 * imp + C_p (1 - imp) \quad \text{(Equation E-7)}$$

Where:

- C = runoff coefficient
- imp = impervious fraction of watershed
- C_p = pervious runoff coefficient, determined using table below

Table E-1: Pervious Runoff Coefficient Based on Ventura Soil Type

Ventura Soil Type (Soil Number)	C_p value
1	0.15
2	0.10
3	0.10
4	0.05
5	0.05
6	0
7	0

- 3) The volume can be calculated using equation E-8 below:

$$SQDV = C * (0.75 / 12) * A_{retain} \quad \text{(Equation E-8)}$$

Where:

- SQDV = the water quality design volume (acre-feet)
- C_{imp} = runoff coefficient, calculated by equation (4) above
- 0.75 = the design rainfall depth (in) [based on sizing method (c)]
- A_{retain} = the drainage area from which runoff must be retained (acres)

Method 4: 80 percent of the average runoff volume using an appropriate public domain continuous flow model

Models that can be used for this calculation include the Storm Water Management Model (SWMM) or Hydrologic Engineering Center – Hydrologic Simulation Program – Fortran (HEC-HSPF)], using the local rainfall record and relevant BMP sizing and design data.

Sizing Method 4 allows for alternative sizing methods to be used as long as the selected method produces a water quality design volume based on historical rainfall records that achieves 80% capture of the average runoff volume. While sizing Methods 2 and 3 are appropriate for low lying areas within Ventura County, continuous simulation (using historical rainfall record) is well suited to sizing BMPs in locations with higher average rainfall. This method is the recommended sizing method for Ventura County, using appropriate local data inputs. For BMP locations at higher elevations, with larger rainfall, Method 1 is also better suited to sizing volume-based BMPs using rainfall representative of the site where the BMP will be located.

Continuous runoff modeling takes a long, uninterrupted record of observed rainfall data and transforms it into a record of runoff data. This is done by use of a set of mathematical algorithms that represent the rainfall-runoff processes. EPA's Stormwater Management Model (U.S. EPA, 2000) (SWMM) is one type of continuous runoff model. The runoff module of SWMM subdivides each drainage area into two inclined planes, one for impervious areas and one for pervious areas. Manning's equation is applied to estimate runoff taking into account rainfall intensity, initial losses, evapotranspiration, and infiltration (for pervious areas). The width and length of each plane is selected based on the drainage area configuration and existing and proposed drainage features. Hourly rainfall data is the primary model input for generating runoff volumes and rates. Additional input data are required to characterize imperviousness, soils, topography, and losses associated with evapotranspiration, infiltration, and initial losses.

Sizing BMPs using this type of alternative should only be conducted by qualified personnel with a thorough understanding of the simulated hydrologic processes and operation of the selected hydrology model.

Methods for Determining the Water Quality Design Flow

Each of the flow-based sizing alternatives is described in detail below.

Method 1: Runoff Produced by 0.2 Inches per Hour Rainfall Intensity

The rainfall analysis for flow-based controls focuses on estimating the design rainfall intensity, which is then converted to a design flow rate using the rational method shown in Equation E-9.

$$SQDF = CiA \quad \text{(Equation E-9)}$$

Where:

- SQDF = design flow rate (cfs)
- C = runoff coefficient, calculated with the Ventura County Hydrology Manual method (see Equation E-5) (unitless)
- i = rainfall intensity (in/hr) (0.2 in/hr)
- A = watershed area (acres)

Note that 1 acre-in/hr = 1.0083 cfs; this conversion factor can be used with Equation D-9, but is not necessary as the uncertainty for the other parameters is generally well above 0.8%.

Method 2: Runoff Produced by Twice the 85th Percentile Rainfall Intensity

This method is analogous to the rational method used in Method 1, except that twice the historical 85th percentile rainfall intensity for the site location is used for the design rainfall intensity. This method is expected to result in a higher design rainfall intensity and design flow rate compared to Method 1 for most of the rain gages in the District.

Method 3: Runoff Produced by eight percent of the 50-year storm design flow rate

The Stormwater Quality Design Flow (SQDF) is defined to be equal to 8 percent of the peak rate of runoff flow from the 50-year storm as determined using the procedures set forth in the *Hydrology Manual*.

Calculation Procedure

- 1) The Stormwater Quality Design Flow (SQDF) in Ventura County is defined as SQDF
- 2) Calculate the peak rate of flow from the 50-year storm ($Q_{P, 50 \text{ yr.}}$) using the procedures set forth in the *Hydrology Manual* or as directed by the local agency Drainage Master Plan.
- 3) Convert $Q_{P, 50\text{yr}}$ (Step 2) to $Q_{P, SQDF}$ (Step 1).

$$Q_{P, SQDF} = 0.1 \times Q_{P, 50\text{yr}} \quad \text{(Equation E-10)}$$

Example Stormwater Quality Design Flow Calculation

The steps below illustrate calculation of SQDF:

- 1) Calculate the peak rate of flow from a 50-year storm.

$$Q_{p, 50 \text{ yr.}} = 10 \text{ cfs from the } \textit{Ventura County Hydrology Manual}$$

- 4) Convert $Q_{p, 50 \text{ yr.}}$ (Step 2) to $Q_{p, \text{SQDF}}$ (Step 1)

$$\text{SQDF} = 0.8 \times 10 \text{ cfs} \quad (\text{Equation E-11})$$

$$\text{SQDF} = 0.8 \text{ cfs}$$

Other Rainfall Analysis Methods

Other rainfall analysis methods are available if a more thorough analysis is desired. The methods listed below have the benefits of including the most recent rainfall data. Additionally, if the site is not close to an isohyet map rainfall gauge, these methods may be more accurate due to the variability of rainfall due to changing microclimates caused by elevation and distance from the ocean.

A resource available for obtaining rainfall data in Ventura County is the data collected and compiled by the National Climatic Data Center (NCDC).

There are many NCDC stations within Ventura County that collect or have collected hourly precipitation data. Some of these stations are no longer in operation and others may not have a sufficiently long period of record over which precipitation data has been collected to be of use for properly sizing treatment BMPs. NCDC data may be obtained online at the NCDC website <http://www.ncdc.noaa.gov/oa/ncdc.html>.

Rainfall Analysis Using EPA'S SYNOP Program

US EPA's Synoptic Rainfall Data Analysis Program (SYNOP) aggregates hourly rainfall data into individual storm events and computes event descriptive statistics. The SYNOP program calculates the duration, volume, and intensity for individual storms as well as average annual statistics. Recurrence interval and probability results are also available as output options. The SYNOP program allows the user to screen out storms that are not expected to result in runoff (see step 2 below).

The SYNOP rainfall analysis is conducted to output event-specific data in addition to average annual statistics. The individual storm event data can be ranked to give the 85th percentile storm or averaged to give the mean storm size.

Steps for conducting SYNOP rainfall analysis are as follows:

- 1) Obtain the hourly rainfall data for the gage of interest from the NCDC or LACDPW.
- 2) Run SYNOP for the available rain gage data. Model input parameters include the inter-event time and a minimum storm event size. The inter-event time specifies the minimum duration in which precipitation does not occur, used to define separate storm events, while the minimum storm event is the depth of precipitation generated by a storm below which runoff generally does not occur.

Typically, an inter-event time of 6 hours (USEPA, 1989), and a minimum storm event size of 0.10 inches are used (i.e., storms of 0.10 inches or less are not considered to produce runoff typically). Model results include event-specific and annual statistics during the period of record analyzed.

- 3) Rank and average the SYNOP storm event output.

References

California Stormwater Quality Association, 2003. Stormwater Best Management Practice Handbook, New Development and Redevelopment, January 2003. <http://www.cabmphandbooks.com/>

Grizzard T.J., C.W. Randall, B.L. Weand, and K.L. Ellis (1986). Effectiveness of Extended Detention Ponds, in Urban Runoff Quality – Impact and Quality Enhancement Technology: pp. 323-337.

Schueler, T., 1987. “Controlling Urban Runoff: A Practical Manual for Planning and Designing Urban BMPs,” Publication No. 87703, Metropolitan Washington Council of Governments, Washington, DC.

USEPA, Driscoll, E.D., E. Strecker, G. Palhegyi, 1989. Analysis of Storm Events, Characteristics for Selected Rain Gauges throughout the United States.

WEF Manual of Practice No. 23/ASCE Manual and Report on Engineering Practice No. 87, 1998: Urban Runoff Quality Management.

E.2 INF-1 Infiltration Basin/ INF-2 Infiltration Trench/ INF-4 Drywell

This worksheet can be used for sizing INF-1 Infiltration Basins, INF-2 Infiltration Trenches, or INF-4 drywells. An infiltration basin is an earthen basin constructed into naturally pervious soils which retains the SQDV and allows the retained runoff to percolate into the underlying native soils over a specified period of time. Infiltration trenches are long, narrow, gravel-filled trenches, often vegetated, that infiltrate stormwater runoff from small drainage areas. Drywells are similar to infiltration trenches, but the geometry and materials are slightly different. A dry well may be either a small excavated pit filled with aggregate or a prefabricated storage chamber or pipe segment, with the depth of the drywell greater than the width.

Sizing Methodology

Infiltration facilities can be sized using one of two methods: a simple sizing method or a routing modeling method. With either method the SQDV volume must be completely infiltrated within 12 to 72 hours (see [Appendix E, Section E.1](#) for a discussion on drawdown time and BMP performance). The simple sizing procedures provided below can be used for either infiltration basins, infiltration trenches (see [INF-2: Infiltration Trench](#)) or drywells (INF-4: Drywell). For the routing modeling method, refer to [VEG-8 Sand Filters](#).

Step 1: Calculate the design volume

Infiltration facilities shall be sized to capture and infiltrate the SQDV volume (see [Section 2](#) and Appendix E) with a 12 - 72 hour drawdown time (see [Appendix E, Section E.1](#)).

Step 2: Determine the Design Percolation Rate

The percolation rate will decline between maintenance cycles as particulates accumulate in the infiltrative layer and the surface becomes occluded. Additionally, monitoring of actual facility performance has shown that the full-scale infiltration rate is far lower than the rate measured by small-scale testing. It is important that adequate conservatism is incorporated in the selection of design percolation rates. For infiltration trenches, the design percolation rate discussed here is the percolation rate of the underlying soils, which will ultimately drive infiltration through the trench, and not the percolation rate of the filter media bed (refer to the "[Geometry and Sizing](#)" section of INF-2 for the recommended composition of the filter media bed for infiltration trenches). See [INF-1: Infiltration Basin](#) for guidance in developing design percolation rate correction factors.

Step 3: Calculate Surface Area

Determine the size of the required infiltrating surface by assuming the SQDV will fill the available ponding depth plus (for infiltration trenches/ drywells with aggregate)

the void spaces within the filter media based on the computed porosity of the media (normally about 32%).

- 1) Determine the maximum depth of runoff that can be infiltrated within the required drain time as follows:

$$d_{\max} = \frac{P_{\text{design}} t}{12} \quad \text{(Equation E-12)}$$

Where:

d_{\max} = the maximum depth of water that can be infiltrated within the required drain time (ft)

P_{design} = design percolation rate of underlying soils (in/hr)

t = required drain time (hrs)

- 2) Choose the ponding depth (d_p) and/or trench depth (d_t) such that:

$$d_{\max} \geq d_p \quad \text{For Infiltration Basins} \quad \text{(Equation E-13)}$$

$$d_{\max} \geq n_t d_t + d_p \quad \text{For Infiltration Trenches or aggregate-filled Drywells} \quad \text{(Equation E-14)}$$

Where:

d_{\max} = the maximum depth of water that can be infiltrated within the required drain time (ft)

d_p = ponding depth (ft)

n_t = trench/drywell fill aggregate porosity (unitless)

d_t = depth of trench/drywell filter media (ft)

- 3) Calculate infiltrating surface area (filter bottom area) required:

$$A = \frac{SQDV}{((TP_{\text{design}}/12) + d_p)} \quad \text{For Infiltration Basins} \quad \text{(Equation E-15)}$$

$$A = \frac{SQDV}{((TP_{\text{design}}/12) + n_t d_t + d_p)} \quad \text{For Infiltration Trenches or aggregate-filled Drywells} \quad \text{(Equation E-16)}$$

Where:

$SQDV$ = stormwater quality design volume (ft³)

n_t	=	trench fill aggregate porosity (unitless)
P_{design}	=	design percolation rate (in/hr)
d_p	=	ponding depth (ft)
d_t	=	depth of trench filter media (ft)
T	=	fill time (time to fill to max ponding depth with water) (hrs) [use 2 hours for most designs]

Step 4: Size the forebay (applies to infiltration basins and trenches)

Infiltration facilities require pre-treatment to reduce sediment load into the basin. If a separate pre-treatment unit is not used, a forebay should be constructed for the facility. If a forebay is used, all inlets must enter the sediment forebay. The sediment forebay must be sized to 25% of the basin volume. The forebay must have interior slopes no steeper than 4:1.

- 1) Calculate the volume of the sediment forebay:

$$V_{forebay} = 0.25 \times SQDV \quad \text{(Equation E-17)}$$

Where:

$V_{forebay}$ = Volume of sediment forebay

$SQDV$ = Stormwater Quality Design Volume of Infiltration Basin

- 2) Select the depth of forebay, $d_{forebay}$. This is recommended to be...

- 3) Determine bottom surface area of forebay:

$$A_{forebay} = \frac{V_{forebay}}{d_{forebay}} \quad \text{(Equation E-18)}$$

Where:

$A_{forebay}$ = Bottom surface area of forebay

$V_{forebay}$ = Volume of forebay

$d_{forebay}$ = Depth of forebay

- 4) Size forebay outlet pipe. Pipe must 8 inches in diameter, minimum, and must be sized such that the forebay drains completely within 10 minutes.

Step 5: Provide conveyance capacity for filter clogging

The infiltration facility should be placed off-line, but an emergency overflow must still be provided in the event the filter becomes clogged. Spillway and overflow

structures should be designed in accordance with applicable standards of the Ventura County Flood Control District or local jurisdiction.

Sizing Worksheet

Step 1: Determine water quality design volume	
1-1. Enter Project area (acres), $A_{project}$	$A_{project} =$ acres
1-2. Enter the maximum allowable percent of the Project area that may be effective impervious area (%) (refer to permit), ranges from 5-30%, $\%_{allowable}$	$\%_{allowable} =$ %
1-3. Determine the maximum allowable effective impervious area (acres), $EIA_{allowable} = (A_{project}) * (\%_{allowable})$	$EIA_{allowable} =$ acres
1-4. Enter Project impervious fraction, Imp (e.g. 60% = 0.60)	$Imp =$
1-5. Determine the Project Total Impervious area (acres), $TIA = A_{project} * Imp$	$TIA =$ acres
1-6. Determine the total area from which runoff must be retained (acres), $A_{retain} = TIA - EIA_{allowable}$	$A_{retain} =$ acres
1-7. Determine pervious runoff coefficient using Table E-1, C_p	$C_p =$
1-8. Calculate runoff coefficient, $C = 0.95 * imp + C_p (1 - imp)$	$C =$
1-9. Enter design rainfall depth of the storm (in), P_i (see Table D-3)	$P_i =$ in
1-10. Calculate rainfall depth (ft), $P = P_i / 12$	$P =$ ft
1-11. Calculate water quality design volume (ft ³), $SQDV = 43560 * C * P * A_{retain}$	$SQDV =$ ft ³
Step 2: Determine the design percolation rate	
2-1. Enter measured soil percolation rate (in/hr, 0.5 in/hr min.), $P_{measured}$	$P_{measured} =$ in/hr

2-2. Determine percolation rate correction factor, S_A based on suitability assessment (see Section 6 INF-1)	$S_A =$
2-3. Determine percolation rate correction factor, S_B based on design (see Section 6 INF-1)	$S_b =$
2-4. Calculate combined safety factor, $S = S_A \times S_b$	$S =$
2-5. Calculate the design percolation rate (in/hr), $P_{design} = P_{measured}/S$	$P_{design} =$ in/hr
Step 3: Calculate the surface area	
3-1. Enter required drain time(hours,72 hrs max.), t	$t =$ hrs
3-2. Calculate max. depth of runoff that can be infiltrated within the t (ft), $d_{max} = P_{design} t/12$	$d_{max} =$ ft
3-3. For basins, select ponding depth (ft), d_p , such that $d_p \leq d_{max}$	$d_p =$ ft
3-4. For trenches, enter trench fill aggregate porosity, n_t	$n_t =$
3-5. For trenches, enter depth of trench fill (ft), d_t	$d_t =$ ft
3-5. For trenches, select ponding depth d_p such that $d_p \leq d_{max} - n_t d_t$	$d_p =$ ft
3-6. Enter the time to fill infiltration basin or trench with water (Use 2 hours for most designs), T	$T =$ hrs
3-7. Calculate infiltrating surface area for infiltration basin (ft ²): $A_b = SQDV/(T P_{design} /12+d_p)$ OR Calculate infiltrating surface area for infiltration trenches or aggregate- filled drywells (ft ²): $A_t = SQDV/(T P_{design} /12+n_t d_t+d_p)$	$A_b =$ ft ² $A_t =$ ft ²
Step 4: Size the forebay (infiltration basins or trenches)	

<p>If a separate pre-treatment unit is designed for the infiltration facility, skip to Step 5. If not, continue through 4-1 through 4-4.</p>	
<p>4-1. Calculate the volume of the forebay (ft³), $V_{\text{forebay}} = 0.25 * SQDV$</p>	<p>$V_{\text{forebay}} =$ ft³</p>
<p>4-2. Determine forebay depth (ft), d_{forebay}</p>	<p>$d_{\text{forebay}} =$ ft</p>
<p>4-3. Calculate forebay bottom surface area (ft²), $A_{\text{forebay}} = V_{\text{forebay}} / d_{\text{forebay}}$</p>	<p>$A_{\text{forebay}} =$ ft²</p>
<p>4-4. Provide outlet pipe such that the forebay drains to the infiltration facility within 10 minutes.</p>	
<p>Step 5: Provide conveyance capacity for filter clogging</p>	
<p>5-1. The infiltration facility should be placed off-line, but an emergency overflow must still be provided in the event the filter becomes clogged. Design emergency overflow in accordance with applicable standards of the Ventura County Flood Control District or local jurisdiction.</p>	

Design Example

Step 1: Determine water quality design volume

For this design example, a 10-acre residential development with a 60% total impervious area is considered to drain to an infiltration basin.

Step 1: Determine water quality design volume	
1-1. Enter Project area (acres), $A_{project}$	$A = 10$ acres
1-2. Enter the maximum allowable percent of the Project area that may be effective impervious area (%) (refer to permit), ranges from 5-30%, $\%_{allowable}$	$\%_{allowable} = 5$
1-3. Determine the maximum allowable effective impervious area (acres), $EIA_{allowable} = (A_{project}) * (\%_{allowable})$	$EIA_{allowable} = 0.5$ acres
1-4. Enter Project impervious fraction, Imp (e.g. 60% = 0.60)	$Imp = 0.6$
1-5. Determine the Project Total Impervious area (acres), $TIA = A_{project} * Imp$	$TIA = 6$ acres
1-6. Determine the total area from which runoff must be retained (acres), $A_{retain} = TIA - EIA_{allowable}$	$A_{retain} = 5.5$ acres
1-7. Determine pervious runoff coefficient using Table E-1 , C_p	$C_p = 0.05$
1-8. Calculate runoff coefficient, $C = 0.95 * imp + C_p (1 - imp)$	$C = 0.59$
1-9. Enter design rainfall depth of the storm (in), P_i (see Table D-3)	$P_i = 0.75$ in
1-10. Calculate rainfall depth (ft), $P = P_i / 12$	$P = 0.06$ ft
1-11. Calculate water quality design volume (ft ³), $SQDV = 43560 * C * P * A_{retain}$	$SQDV = 8,500$ ft ³

Step 2: Calculate Design Infiltration Rate

Infiltration facilities require a minimum soil infiltration rate of 0.5 in/hr. If the rate exceeds 2.4 in/hr as in this example, then the runoff should be fully treated in an upstream BMP prior to infiltration to protect the groundwater quality.

Step 2: Determine the design percolation rate	
2-1. Enter measured soil percolation rate (0.5 in/hr min.), $P_{measured}$	$P_{measured} = 4.0 \text{ in/hr}$
2-2. Determine percolation rate correction factor, S_A , based on suitability assessment (see Section 6 INF-1)	$S_A = 3$
2-3. Determine percolation rate correction factor, S_B , based on design (see Section 6 INF-1)	$S_b = 3$
2-4. Calculate combined safety factor, $S = S_A \times S_b$	$S = 9$
2-5. Calculate the design percolation rate, $P_{design} = P_{measured}/S$	$P_{design} = 0.44 \text{ in/hr}$

Step 3: Determine Facility Size

The size of the infiltrating surface is determined by assuming the SQDV will fill the available ponding depth (plus the void spaces of the computed porosity (usually about 32%) of the gravel in the trench).

Step 3: Calculate the surface area	
3-1. Enter drawdown time (72 hrs max.), t_d	$t = 72 \text{ hrs}$
3-2. Calculate max. depth of runoff that can be infiltrated within the t , $d_{max} = P_{design} t/12$	$d_{max} = 2.4 \text{ ft}$
3-3. Enter trench fill aggregate porosity, n_t	$n_t = 0.32$
3-4. Enter depth of trench fill, d_t	$d_t = 4 \text{ ft}$
3-5. Select trench ponding depth d_p such that $d_p \leq d_{max} - n_t d_t$	$d_p = 1.1 \text{ ft}$
3-6. Enter the time to fill infiltration basin or trench with water (Use 2 hours for most designs), T	$T = 2 \text{ hrs}$

3-7. Calculate infiltrating surface area for infiltration basin: $A_b = SQDV / (T P_{design} / 12 + d_p)$	$A_b = 7,250 \text{ ft}^2$
---	----------------------------

Step 4: Size the Forebay

A sediment forebay will be provided for this example as there is no separate pre-treatment unit provided.

Step 4: Size the forebay	
4-1. Calculate the volume of the forebay, $V_{forebay} = 0.25 * SQDV$	$V_{forebay} = 2,100 \text{ ft}^3$
4-2. Determine forebay depth, $d_{forebay}$	$d_{forebay} = 3 \text{ ft}$
4-3. Calculate forebay bottom surface area, $A_{forebay} = V_{forebay} / d_{forebay}$	$A_{forebay} = 700 \text{ ft}^2$
4-4. Provide outlet pipe such that the forebay drains to the infiltration facility within 10 minutes.	

Step 5: Provide Conveyance Capacity for Flows Higher than Q_{wq}

The infiltration facility should be placed off-line, but an emergency overflow for flows greater than the peak design storm must still be provided in the event the filter becomes clogged. Design emergency overflow in accordance with applicable standards of the Ventura County Flood Control District or local jurisdiction.

E.3 INF-3 Bioretention

Sizing Methodology

Bioretention areas can be sized using one of two methods: a simple sizing method or a routing method. The simple sizing procedure is summarized below. Continuous simulation modeling, routing spreadsheets, and/or other forms of routing modeling that incorporate rainfall-runoff relationships and infiltrative (flow) capacities of bioretention may be used to size facilities. Alternative sizing methodologies should be prepared with good engineering practices. For the routing modeling method, refer to the Sand Filter design guidance (FILT-1). A bioretention sizing worksheet and example are provided in this appendix. Planter boxes are sized the same as bioretention areas with underdrains using parameters appropriate for planter boxes.

With either method, the runoff entering the facility must completely drain the ponding area within 48 hours, and runoff must be completely infiltrated within 96 hours. Bioretention is to be sized, with or without underdrains, such that the SQDV will fill the available ponding depth, the void spaces in the planting soil, and the optional gravel layer below the media.

Step 1: Determine the stormwater quality design volume (SQDV)

Bioretention areas should be sized to capture and treat the water quality design volume (see Section E.1).

Step 2: Determine the Design Percolation Rate

The percolation rate will decline between maintenance cycles as particulates accumulate in the infiltrative layer and the surface becomes occluded. Additionally, monitoring of actual facility performance has shown that the full-scale infiltration rate is far lower than the rate measured by small-scale testing. It is important that adequate conservatism is incorporated in the selection of design percolation rates. For infiltrating bioretention facilities, the design percolation rate discussed here is the percolation rate of the underlying soils, which will drive infiltration through the facility. See [INF-3: Bioretention](#) for guidance in developing design percolation rate correction factors.

Step 3: Calculate the bioretention surface area

- 1) Determine the maximum depth of surface ponding that can be infiltrated within the required surface drain time:

$$d_{\max} = \frac{P_{\text{design}} \times t_{\text{ponding}}}{12 \frac{\text{in}}{\text{ft}}}$$

Where:

- $t_{ponding}$ = required drain time of surface ponding (48 hrs)
- P_{design} = design percolation rate of underlying soils (in/hr) (see Step 2, above)
- d_{max} = the maximum depth of surface ponding water that can be infiltrated within the required drain time (ft)

2) Choose surface ponding depth (d_p) such that:

$$d_p \leq d_{max} \quad \text{(Equation E-19)}$$

Where:

- d_p = selected surface ponding depth (ft)
- d_{max} = the maximum depth of water that can be infiltrated within the required drain time (ft)

3) Choose thickness(es) of amended media and aggregate layer(s) and calculate total effective storage depth of the bioretention area as follows:

$$d_{effective} \leq d_p + n_{media}^* l_{media} + n_{gravel} l_{gravel} \quad \text{(Equation E-20)}$$

Where:

- $d_{effective}$ = total equivalent depth of water stored in bioretention area (ft)
- d_p = surface ponding depth (ft)
- n_{media}^* = available porosity of amended soil media (ft/ft), approximately 0.25 ft/ft accounting for antecedent moisture conditions
- l_{media} = thickness of amended soil media layer (ft)
- n_{gravel} = porosity of optional gravel layer (ft/ft), approximately 0.30 ft/ft
- l_{gravel} = thickness of optional gravel layer (ft)

4) Check that entire effective depth (surface plus subsurface storage) infiltrates in no greater than 96 hours as follows:

$$t_{total} = \frac{d_{effective}}{P_{design}} \times 12 \frac{in}{ft} \leq 96 \text{ hr} \quad \text{(Equation E-21)}$$

Where:

$d_{effective}$ = total equivalent depth of water stored in bioretention area (ft)
 P_{design} = design percolation rate of underlying soils (in/hr) (see Step 2, above)

If $t_{total} > 96$ hrs, then reduce surface ponding depth and/or amended media thickness and/or gravel thickness and return to Step [A].

If $t_{total} \leq 96$ hrs, then proceed to Step [E].

5) Calculate required infiltrating surface area (filter bottom area):

$$A_{req} = \frac{SQDV}{d_{effective}} \quad \text{(Equation E-22)}$$

Where:

$SQDV$ = stormwater quality design volume (ft³)

Step 4: Calculate the bioretention total footprint

Calculate total footprint required by including a buffer for side slopes and freeboard; A_{req} is measured at the as the filter bottom area (toe of side slopes).

Sizing Worksheet

Step 1: Determine water quality design volume	
1-1. Enter Project area (acres), $A_{project}$	$A_{project} =$ acres
1-2. Enter the maximum allowable percent of the Project area that may be effective impervious area (%) (refer to permit), ranges from 5-30%, $\%_{allowable}$	$\%_{allowable} =$ %
1-3. Determine the maximum allowable effective impervious area (acres), $EIA_{allowable} = (A_{project}) * (\%_{allowable})$	$EIA_{allowable} =$ acres
1-4. Enter Project impervious fraction, Imp (e.g. 60% = 0.60)	$Imp =$
1-5. Determine the Project Total Impervious area (acres), $TIA = A_{project} * Imp$	$TIA =$ acres
1-6. Determine the total area from which runoff must be retained (acres), $A_{retain} = TIA - EIA_{allowable}$	$A_{retain} =$ acres
1-7. Determine pervious runoff coefficient using Table E-1, C_p	$C_p =$
1-8. Calculate runoff coefficient, $C = 0.95 * imp + C_p (1 - imp)$	$C =$
1-9. Enter design rainfall depth of the storm (in), P_i (see Table D-3)	$P_i =$ in
1-10. Calculate rainfall depth (ft), $P = P_i / 12$	$P =$ ft
1-11. Calculate water quality design volume (ft ³), $SQDV = 43560 * C * P * A_{retain}$	$SQDV =$ ft ³
Step 2: Determine the design percolation rate	
2-1. Enter measured soil percolation rate (in/hr) (0.5 in/hr minimum), $P_{measured}$	$P_{measured} =$ in/hr

2-2. Determine percolation rate correction factor, S_A based on suitability assessment (see Section 6 INF-3)	$S_A =$
2-3. Determine percolation rate correction factor, S_B based on design (see Section 6 INF-3)	$S_B =$
2-4. Calculate combined safety factor, $S = S_A \times S_b$	$S =$
2-5. Calculate the design percolation rate (in/hr), $P_{design} = P_{measured}/S$	$P_{design} =$ in/hr
Step 3: Calculate Bioretention Infiltrating surface area	
3-1. Enter water quality design volume (ft ³), $SQDV$	$SQDV =$ ft ³
3-2. Enter design percolation rate (in/hr), P_{design}	$P_{design} =$ in/hr
3-3 Enter the required drain time (48 hours), $t_{ponding}$	$t_{ponding} =$ hours
3-3. Calculate the maximum depth of surface ponding that can be infiltrated within the required drain time (ft): $d_{max} = (P_{design} \times t_{ponding})/12$	$d_{max} =$ ft
3-4. Select surface ponding depth (ft), d_p , such that $d_p \leq d_{max}$	$d_p =$ ft
3-5. Select thickness of amended media (ft, 2 feet minimum, 3 preferred), l_{media}	$l_{media} =$ ft
3-6. Enter porosity of amended media (roughly 25% or 0.25 ft/ft), n_{media}	$n_{media} =$ ft/ft
3-7. Select thickness of optional gravel layer (ft), l_{gravel}	$l_{gravel} =$ ft
3-8. Enter porosity of gravel (roughly 30% or 0.3 ft/ft), n_{gravel}	$n_{gravel} =$ ft/ft

<p>3-9. Calculate the total effective storage depth of bioretention facility (ft):</p> $d_{effective} \leq (d_p + n_{media}l_{media} + n_{gravel}l_{gravel})$	$d_{effective} = \quad \text{ft}$
<p>3-10. Check that the entire effective depth infiltrates in required drainage time, 96 hours:</p> $t_{total} = (d_{effective}/P_{design}) \times 12$ <p>If $t_{total} > 96$ hours, reduce surface ponding depth and/or amended media thickness and/or gravel thickness and return to 3-4.</p> <p>If $t_{total} \leq 96$ hours, proceed to 3-11.</p>	$t_{total} = \quad \text{hours}$
<p>3-11. Calculate the required infiltrating surface area (ft²):</p> $A_{req} = SQDV/d_{effective}$	$A_{req} = \quad \text{ft}^2$
<p>Step 4: Calculate Bioretention Area Total Footprint</p>	
<p>4-1. Calculate total footprint required by including a buffer for side slopes and freeboard (ft²) [A_{req} is measured at the as the filter bottom area (toe of side slopes)], A_{tot}</p>	$A_{tot} = \quad \text{ft}^2$

Design Example

Bioretention areas have several components that allow the pretreatment, spreading, filtration, collection and discharge of the incoming flows.

Step 1: Determine water quality design volume

For this design example, a 10-acre site with soil type 4 and 60% total impervious area is considered.

Step 1: Determine water quality design volume	
1-1. Enter Project area (acres), $A_{project}$	$A_{project} = 10$ acres
1-2. Enter the maximum allowable percent of the Project area that may be effective impervious area (%) (refer to permit), ranges from 5-30%, $\%_{allowable}$	$\%_{allowable} = 5$
1-3. Determine the maximum allowable effective impervious area (acres), $EIA_{allowable} = (A_{project}) * (\%_{allowable})$	$EIA_{allowable} = 0.5$ acres
1-4. Enter Project impervious fraction, Imp (e.g. 60% = 0.60)	$Imp = 0.6$
1-5. Determine the Project Total Impervious area (acres), $TIA = A_{project} * Imp$	$TIA = 6$ acres
1-6. Determine the total area from which runoff must be retained (acres), $A_{retain} = TIA - EIA_{allowable}$	$A_{retain} = 5.5$ acres
1-7. Determine pervious runoff coefficient using <u>Table E-1</u> , C_p	$C_p = 0.05$
1-8. Calculate runoff coefficient, $C = 0.95 * imp + C_p (1 - imp)$	$C = 0.59$
1-9. Enter design rainfall depth of the storm (in), P_i (see Table D-3)	$P_i = 0.75$ in
1-10. Calculate rainfall depth (ft), $P = P_i / 12$	$P = 0.06$ ft
1-11. Calculate water quality design volume (ft ³), $SQDV = 43560 * C * P * A_{retain}$	$SQDV = 8,500$ ft ³

Step 2: Determine the design percolation rate

For this design example, a native soil percolation rate of 1.5 in/hr is assumed.

Step 2: Determine the design percolation rate	
2-1. Enter measured soil percolation rate (in/hr, 0.5 in/hr minimum), $P_{measured}$	$P_{measured} = 4.0 \text{ in/hr}$
2-2. Determine percolation rate correction factor, S_A , based on suitability assessment (see Section 6 INF-1)	$S_A = 3$
2-3. Determine percolation rate correction factor, S_B , based on design (see Section 6 INF-1)	$S_B = 3$
2-4. Calculate combined safety factor, $S = S_A \times S_B$	$S = 9$
2-5. Calculate the design percolation rate (in/hr), $P_{design} = P_{measured}/S$	$P_{design} = 0.44 \text{ in/hr}$

Step 3: Determine bioretention/ planter box area foot

A bioretention area is designed with two components: (1) temporary storage reservoir to store runoff, and (2) a plant mix filter bed (planting soil mixed with sand content = 70%) through which the stored runoff must percolate to obtain treatment.

Step 3: Calculate bioretention/planter box surface area	
3-1. Enter water quality design volume (ft ³), $SQDV$	$SQDV = 8,500 \text{ ft}^3$
3-2. Enter design percolation rate (in/hr), P_{design}	$P_{design} = 0.375 \text{ in/hr}$
3-3 Enter the required drain time (48 hours), $t_{ponding}$	$t_{ponding} = 48 \text{ hours}$
3-3. Calculate the maximum depth of surface ponding (ft) that can be infiltrated within the required drain time (48 hours): $d_{max} = (P_{design} \times t_{ponding})/12$	$d_{max} = 1.5 \text{ ft}$
3-4. Select surface ponding depth d_p such that $d_p \leq d_{max}$	$d_p = 1.5 \text{ ft}$
3-5. Select thickness of amended media (2 feet minimum, 3 preferred), l_{media}	$l_{media} = 3 \text{ ft}$

<p>3-6. Enter porosity of amended media (roughly 25% or 0.25 ft/ft), n_{media}</p>	<p>$n_{media} = 0.25 \text{ ft/ft}$</p>
<p>3-7. Select thickness of optional gravel layer (ft), l_{gravel}</p>	<p>$l_{gravel} = 1 \text{ ft}$</p>
<p>3-8. Enter porosity of gravel (roughly 30% or 0.3 ft/ft), n_{gravel}</p>	<p>$n_{gravel} = 0.3 \text{ ft/ft}$</p>
<p>3-9. Calculate the total effective storage depth of bioretention facility (ft):</p> $d_{effective} \leq (d_p + n_{media}l_{media} + n_{gravel}l_{gravel})$	<p>$d_{effective} = 2.6 \text{ ft}$</p>
<p>3-10. Check that the entire effective depth infiltrates in required drainage time, 96 hours:</p> $t_{total} = (d_{effective}/P_{design}) \times 12$ <p>If $t_{total} > 96$ hours, reduce surface ponding depth and/or amended media thickness and/or gravel thickness and return to 3-4.</p> <p>If $t_{total} \leq 96$ hours, proceed to 3-11.</p>	<p>$t_{total} = 82 \text{ hours}$</p>
<p>3-11. Calculate the required infiltrating surface area (ft²), $A_{req} = SQDV/d_{effective}$</p>	<p>$A_{req} = 3,300 \text{ ft}^2$</p>

Step 4: Calculate Bioretention Area Total Footprint

For this design example, a natural-shaped bioretention area is assumed, with 3:1 side slopes. To calculate the total footprint, the side slopes would be added to the design geometry.

E.4 INF-5 Permeable Pavement

Sizing Methodology

Permeable pavement (including the base layers) shall be designed to drain in less than 72 hours. The basis for this is that soils must be allowed to dry out periodically in order to restore hydraulic capacity; this is essential in order to receive flows from subsequent storms, maintain infiltration rates, maintain adequate sub soil oxygen levels for healthy soil biota, and to provide proper soil conditions for biodegradation and retention of pollutants.

Permeable pavement must be built and designed by a licensed civil engineer in accordance with Ventura County roadway and pavement specifications.

Step 1: Calculate the design volume

Permeable pavement shall be sized to capture and treat the stormwater quality design volume, SQDV (see [Section 2](#) and Appendix E).

Step 2: Determine the Design Percolation Rate

The percolation rate will decline between maintenance cycles as particulates accumulate in the infiltrative layer and the surface becomes occluded. Additionally, monitoring of actual facility performance has shown that the full-scale infiltration rate is far lower than the rate measured by small-scale testing. It is important that adequate conservatism is incorporated in the selection of design percolation rates. For infiltrating bioretention facilities, the design percolation rate discussed here is the percolation rate of the underlying soils, which will drive infiltration through the facility. See INF-5: Permeable Pavement for guidance in developing design percolation rate correction factors.

Step 3: Determine gravel drainage layer depth

Permeable pavement (including the base layers) shall be designed to drain in less than 72 hours. The basis for this is that soils must be allowed to dry out periodically in order to restore hydraulic capacity to receive flows from subsequent storms, maintain infiltration rates, maintain adequate sub soil oxygen levels for healthy soil biota, and to provide proper soil conditions for biodegradation and retention of pollutants.

- 1) Calculate the maximum depth of runoff, d_{max} , that can be infiltrated within the drawdown time:

$$d_{max} = \frac{P_{design} \cdot t}{12} \quad \text{(Equation E-23)}$$

Where:

- d_{max} = maximum depth that can be infiltrated (ft)
 P_{design} = design percolation rate of underlying soils (in/hr) (see Step 2, above)
 t = drawdown time (72 hrs maximum) (hr)

- 1) Select the gravel drainage layer depth, l , such that:

$$d_{max} \geq n \times l \quad \text{(Equation E-24)}$$

Where:

- d_{max} = maximum depth that can be infiltrated (ft) (see 1) above)
 n = gravel drainage layer porosity (unitless) (generally about 32% or 0.32 for gravel)
 l = gravel drainage layer depth (ft)

Step 4: Determine infiltrating surface area

- 1) Calculate infiltrating surface area for permeable pavement, A :

$$A = \frac{SQDV}{\frac{TP_{design}}{12} + nl} \quad \text{(Equation E-25)}$$

Where:

- P_{design} = design percolation rate of underlying soils (in/hr) (see Step 2, above)
 n = gravel drainage layer porosity (unitless) [about 32% or 0.32 for gravel]
 l = depth of gravel drainage layer (ft)
 T = time to fill the gravel drainage layer with water (use 2 hours for most designs) (hr)

Step 5: Provide conveyance capacity for clogging

The permeable pavement must have an emergency overflow for storm events greater than the design and in the event the permeable pavement becomes clogged. See INF-5 Permeable Pavement for overflow details.

Sizing Worksheet

Step 1: Determine water quality design volume	
1-1. Enter Project area (acres), $A_{project}$	$A_{project} =$ acres
1-2. Enter the maximum allowable percent of the Project area that may be effective impervious area (%) (refer to permit), ranges from 5-30%, $\%_{allowable}$	$\%_{allowable}$ %
1-3. Determine the maximum allowable effective impervious area (acres), $EIA_{allowable} = (A_{project}) * (\%_{allowable})$	$EIA_{allowable} =$ acres
1-4. Enter Project impervious fraction, Imp (e.g. 60% = 0.60)	$Imp =$
1-5. Determine the Project Total Impervious area (acres), $TIA = A_{project} * Imp$	$TIA =$ acres
1-6. Determine the total area from which runoff must be retained (acres), $A_{retain} = TIA - EIA_{allowable}$	$A_{retain} =$ acres
1-7. Determine pervious runoff coefficient using Table E-1 , C_p	$C_p =$
1-8. Calculate runoff coefficient, $C = 0.95 * imp + C_p (1 - imp)$	$C =$
1-9. Enter design rainfall depth of the storm (in), P_i (see Table D-3)	$P_i =$ in
1-10. Calculate rainfall depth (ft), $P = P_i / 12$	$P =$ ft
1-11. Calculate water quality design volume (ft ³), $SQDV = 43560 * C * P * A_{retain}$	$SQDV =$ ft ³
Step 2: Determine the design percolation rate	
2-1. Enter measured soil percolation rate (0.5 in/hr minimum), $P_{measured}$	$P_{measured} =$ in/hr
2-2. Determine percolation rate correction factor, S_A based on suitability assessment (see Section 6 INF-5)	$S_A =$

2-3. Determine percolation rate correction factor, S_B based on design (see Section 6 INF-5)	$S_B =$
2-4. Calculate combined safety factor, $S = S_A \times S_b$	$S =$
2-5. Calculate the design percolation rate (in/hr), $P_{design} = P_{measured}/S$	$P_{design} =$ in/hr
Step 3: Determine the Gravel Drainage Layer Depth	
3-1. Enter drawdown time (hours, 72 hrs max.), t	$t =$ hours
3-2. Calculate max. depth of runoff (ft) that can be infiltrated within the t , $d_{max} = P_{design}t/12$	$d_{max} =$ ft
3-3. Enter the gravel drainage layer porosity, n (typically 32% or 0.32 for gravel)	$n =$
3-4. Select the gravel drainage layer depth (ft) such that $d_{max} \geq n \times l$	$l =$ ft
Step 4: Determine infiltrating surface area	
4-1. Enter gravel drainage layer porosity, n	$n =$
4-2. Enter depth of gravel drainage layer (ft), l	$l =$ ft
4-3. Enter the time to fill the gravel drainage layer with water (Use 2 hours for most designs), T	$T =$ hrs
4-4. Calculate infiltrating surface area (ft ²): $A = SQDV / ((TP_{design}/12) + nl)$	$A =$ ft ²
Step 5: Provide conveyance capacity for clogging	
5-1. The permeable pavement must have an emergency overflow for storm events greater than the design and in the event the permeable pavement becomes clogged.	

Design Example

Step 1: Determine Water Quality Design Volume

For this design example, a 10-acre residential development with a 60% total impervious area is considered.

Step 1: Determine Water Quality Design Volume	
1-1. Enter Project area (acres), $A_{project}$	$A = 10$ acres
1-2. Enter the maximum allowable percent of the Project area that may be effective impervious area (%) (refer to permit), ranges from 5-30%, $\%_{allowable}$	$\%_{allowable} = 5$
1-3. Determine the maximum allowable effective impervious area (acres), $EIA_{allowable} = (A_{project}) * (\%_{allowable})$	$EIA_{allowable} = 0.5$ acres
1-4. Enter Project impervious fraction, Imp (e.g. 60% = 0.60)	$Imp = 0.6$
1-5. Determine the Project Total Impervious area (acres), $TIA = A_{project} * Imp$	$TIA = 6$ acres
1-6. Determine the total area from which runoff must be retained (acres), $A_{retain} = TIA - EIA_{allowable}$	$A_{retain} = 5.5$ acres
1-7. Determine pervious runoff coefficient using Table E-1 , C_p	$C_p = 0.05$
1-8. Calculate runoff coefficient, $C = 0.95 * imp + C_p (1 - imp)$	$C = 0.59$
1-9. Enter design rainfall depth of the storm (in), P_i (see Table D-3)	$P_i = 0.75$ in
1-10. Calculate rainfall depth (ft), $P = P_i / 12$	$P = 0.06$ ft
1-11. Calculate water quality design volume (ft ³), $SQDV = 43560 * C * P * A_{retain}$	$SQDV = 8,500$ ft ³

Step 2: Calculate Design Percolation Rate

Permeable pavement with no underdrain requires a minimum soil infiltration rate of 0.5 in/hr. For this design example, a native soil percolation rate of 1.5 in/hr is assumed.

Step 2: Determine the design percolation rate	
2-1. Enter measured soil percolation rate (0.5 in/hr min.), $P_{measured}$	$P_{measured} = 4.0 \text{ in/hr}$
2-2. Determine percolation rate correction factor, S_A , based on suitability assessment (see Section 6 INF-1)	$S_A = 3$
2-3. Determine percolation rate correction factor, S_B , based on design (see Section 6 INF-1)	$S_b = 3$
2-4. Calculate combined safety factor, $S = S_A \times S_b$	$S = 9$
2-5. Calculate the design percolation rate (in/hr), $P_{design} = P_{measured}/S$	$P_{design} = 0.44 \text{ in/hr}$

Step 3: Determine maximum depth that can be infiltrated

Based on the design infiltration rate and the max drawdown, determine the maximum depth that can be infiltrated within the time constraints.

Step 3: Determine maximum depth that can be infiltrated	
3-1. Enter drawdown time (72 hrs max.), t	$t = 72 \text{ hrs}$
3-2. Calculate max. depth of runoff (ft) that can be infiltrated within the t , $d_{max} = P_{design}t/12$	$d_{max} = 2.6 \text{ ft}$
3-3. Enter the gravel drainage layer porosity, n (typically 32% or 0.32 for gravel)	$n = 0.32$
3-4. Select the gravel drainage layer depth (ft) such that $d_{max} \geq n \times l$	$l = 8 \text{ ft}$

Step 4: Determine the infiltrating surface area (pavement area)

Using the depth calculated in Step 3, the required infiltrating surface area of the pavement can be calculated.

Step 4: Determine the infiltrating surface area	
4-1. Enter gravel drainage layer porosity, n	$n = 0.32$
4-2. Enter depth of gravel drainage layer (ft), l	$l = 8 \text{ ft}$
4-3. Enter the time to fill the gravel drainage layer with water (Use 2 hours for most designs), T	$T = 2 \text{ hrs}$
4-4. Calculate infiltrating surface area (ft ³): $A = SQDV / ((TP_{design} / 12) + n * l)$	$A = 1,630 \text{ ft}^2$

Step 5: Provide conveyance capacity for clogging

The permeable pavement must have an emergency overflow for storm events greater than the design and in the event the permeable pavement becomes clogged.



E.5 VEG-1 Bioretention/VEG-2 Planter Box

Sizing Methodology

Bioretention areas can be sized using one of two methods: a simple sizing method or a routing method. The simple sizing procedure is summarized below. Continuous simulation modeling, routing spreadsheets, and/or other forms of routing modeling that incorporate rainfall-runoff relationships and infiltrative (flow) capacities of bioretention may be used to size facilities. Alternative sizing methodologies should be prepared with good engineering practices. For the routing modeling method, refer to the Sand Filter design guidance (FILT-1). A bioretention sizing worksheet and example are provided in this appendix. Planter boxes are sized the same as bioretention areas with underdrains using parameters appropriate for planter boxes.

With either method, the runoff entering the facility must completely drain the ponding area within 48 hours, and runoff must be completely infiltrated within 96 hours. Bioretention is to be sized, with or without underdrains, such that the SQDV will fill the available ponding depth, the void spaces in the planting soil, and the optional aggregate layer.

Step 1: Determine the stormwater quality design volume (SQDV)

Bioretention areas should be sized to capture and treat the water quality design volume (see Section E.1).

Step 2: Determine the Design Percolation Rate

Sizing is based on the design saturated hydraulic conductivity (K_{sat}) of the amended soil layer. A target K_{sat} of 5 inches per hour is recommended for newly installed non-proprietary amended soil media. The media K_{sat} will decline between maintenance cycles as the surface becomes occluded and particulates accumulate in the amended soil layer. A factor of safety of 2.0 should be applied such that the resulting recommended design percolation rate is 2.5 inches per hour. This value should be used for sizing unless sufficient rationale is provided to justify a higher design percolation rate.

Step 3: Calculate the bioretention or planter box surface area

Determine the size of the required infiltrating surface by assuming the SQDV will fill the available ponding depth plus the void spaces in the media, based on the computed porosity of the filter media and optional aggregate layer.

- 1) Select a surface ponding depth (d_p) that satisfies geometric criteria and congruent with the constraints of the site. Selecting a deeper ponding depth (18 inches maximum) generally yields a smaller footprint, however requires greater consideration for public safety and energy dissipation.



- 2) Compute time for selected ponding depth to filter through media:

$$t_{ponding} = \frac{d_p}{K_{design}} 12 \frac{in}{ft} \leq 48 \text{ hours} \quad (\text{Equation E-26})$$

Where:

- $t_{ponding}$ = required drain time of surface ponding (48 hrs)
 d_p = selected surface ponding water depth (ft)
 K_{design} = design saturated hydraulic conductivity (in/hr) (see Step 2, above)

If $t_{ponding}$ exceeds 48 hours, return to (1) and reduce surface ponding or increase media K_{design} . Otherwise, proceed to next step.

Note: In nearly all cases, $t_{ponding}$ will not approach 48 hours unless a low K_{design} is specified.

- 3) Compute depth of water that may be considered to be filtered during the design storm event as follows:

$$d_{filtered} = \text{Minimum} \left[\frac{K_{design} \times T_{routing}}{12 \frac{in}{ft}}, \frac{d_p}{2} \right] \quad (\text{Equation E-27}),$$

Where:

- $d_{filtered}$ = depth of water that may be considered to be filtered during the design storm event (ft) for routing calculations; this value should not exceed half of the surface ponding depth (d_p)
 K_{design} = design saturated hydraulic conductivity (in/hr) (see Step 2, above)
 $T_{routing}$ = storm duration that may be assumed for routing calculations; this should be assumed to be **3 hours** unless rationale for an alternative assumption is provided
 d_p = selected surface ponding water depth (ft)

- 4) Calculate required infiltrating surface area (filter bottom area):

$$A_{req} = \frac{SQDV}{d_p + d_{filtered}} \quad (\text{Equation E-28})$$

Where:

A_{req}	=	required area at bottom of filter area (ft ²); does not account for side slopes and freeboard
$SQDV$	=	stormwater quality design volume (ft ³)
d_p	=	selected surface ponding water depth (ft)
$d_{filtered}$	=	depth of water that can be considered to be filtered during the design storm event (ft) for routing calculations (See previous step)

Step 4: Calculate the bioretention total footprint

Calculate total footprint required by including a buffer for side slopes and freeboard; A_{req} is measured at the filter bottom area (toe of side slopes).

Step 5: Calculate underdrain system capacity

Underdrains are required for planter boxes and bioretention with underdrains. For guidance on sizing, refer to step 5 of the worksheet below. Alternatively, the Ventura County Hydrology Manual can be used for pipe sizing guidance.

Sizing Worksheet

Step 1: Determine water quality design volume	
1-1. Enter Project area (acres), $A_{project}$	$A_{project} =$ acres
1-2. Enter the maximum allowable percent of the Project area that may be effective impervious area (refer to permit), ranges from 5-30%, $\%_{allowable}$	$\%_{allowable}$ %
1-3. Determine the maximum allowed effective impervious area (ac), $EIA_{allowable} = (A_{project}) * (\%_{allowable})$	$EIA_{allowable} =$ acres
1-4. Enter Project impervious fraction, Imp (e.g. 60% = 0.60)	$Imp =$
1-5. Determine the Project Total Impervious area (acres), $TIA = A_{project} * Imp$	$TIA =$ acres
1-6. Determine the total area from which runoff must be retained (acres), $A_{retain} = TIA - EIA_{allowable}$	$A_{retain} =$ acres
1-7. Determine pervious runoff coefficient using Table E-1 , C_p	$C_p =$
1-8. Calculate runoff coefficient, $C = 0.95 * imp + C_p (1 - imp)$	$C =$
1-9. Enter design rainfall depth of the storm (in), P_i (see Table D-3)	$P_i =$ in
1-10. Calculate rainfall depth (ft), $P = P_i / 12$	$P =$ ft
1-11. Calculate water quality design volume (ft ³), $SQDV = 43560 * C * P * A_{retain}$	$SQDV =$ ft ³
Step 2: Determine the design percolation rate	
2-1. Enter the design saturated hydraulic conductivity of the amended filter media (2.5 in/hr recommended rate), K_{design}	$K_{design} =$ in/hr

Step 3: Calculate Bioretention/Planter Box surface area		
3-1. Enter water quality design volume (ft ³), <i>SQDV</i>	<i>SQDV</i> =	ft ³
3-2. Enter design saturated hydraulic conductivity (in/hr), <i>K_{design}</i>	<i>K_{design}</i> =	in/hr
3-3. Enter ponding depth (max 1.5 ft for Bioretention, 1 ft for Planter Box) above area, <i>d_p</i>	<i>d_p</i> =	ft
3-4. Calculate the drawdown time for the ponded water to filter through media (hours), <i>t_{ponding}</i> = (<i>d_p</i> / <i>K_{design}</i>) × 12	<i>t_{ponding}</i> =	hrs
3-5. Enter the storm duration for routing calculations (use 3 hours unless there is rationale for an alternative), <i>T_{routing}</i>	<i>T_{routing}</i> =	hrs
3-6. Calculate depth of water (ft) filtered by using the following two equations: <i>d_{filtered,1}</i> = (<i>K_{design}</i> × <i>T_{routing}</i>)/12 <i>d_{filtered,2}</i> = <i>d_p</i> / 2	<i>d_{filtered,1}</i> = <i>d_{filtered,2}</i> =	ft ft
3-7 Enter the resultant depth (ft) (the lesser of the two calculated above), <i>d_{filtered}</i>	<i>d_{filtered}</i> =	ft
3-8. Calculate the infiltrating surface area as follows (ft ²): <i>A_{req}</i> = <i>SQDV</i> /(<i>d_p</i> + <i>d_{filtered}</i>)	<i>A_{req}</i> =	ft ²
Step 4: Calculate Bioretention Area Total Footprint		
4-1. Calculate total footprint required by including a buffer for side slopes and freeboard (ft ²) [<i>A_{req}</i> is measured at the as the filter bottom area (toe of side slopes)], <i>A_{tot}</i>	<i>A_{tot}</i> =	ft ²
Step 5: Calculate Underdrain System Capacity		
To calculate the underdrain system capacity, continue through steps 5-1 to 5-7.		

5-1. Calculated filtered flow rate to be conveyed by the longitudinal drain pipe, $Q_f = K_{design} A_{req}/43,200$	$Q_f =$ cfs
5-2. Enter minimum slope for energy gradient, S_e	$S_e =$
5-3. Enter Hazen-Williams coefficient for plastic, C_{HW}	$C_{HW} =$
5-4. Enter pipe diameter (min 6 inches), D	$D =$ in
5-5. Calculate pipe hydraulic radius (ft), $R_h = D/48$	$R_h =$ ft
5-6. Calculate velocity at the outlet of the pipe (ft/s), $V_p = 1.318C_{HW}R_h^{0.63}S_e^{0.54}$	$V_p =$ ft/s
5-7. Calculate pipe capacity (cfs), $Q_{cap} = 0.25\pi(D/12)^2V_p$	$Q_{cap} =$ cfs

Design Example

Bioretention areas have several components that allow the pretreatment, spreading, filtration, collection and discharge of the incoming flows.

Step 1: Determine water quality design volume

For this design example, a 10-acre residential development with a 60% total impervious area is considered.

Step 1: Determine Water Quality Design Volume	
1-1. Enter drainage area, A	A = 10 acres
1-2. Enter the maximum allowable percent of the Project area that may be effective impervious area (refer to permit), ranges from 5-30%, $\%_{allowable}$	$\%_{allowable} = 5$
1-3. Determine the maximum allowed effective impervious area, $EIA_{allowable} = (A_{project}) * (\%_{allowable})$	$EIA_{allowable} = 0.5$ acres
1-4. Enter Project impervious fraction, Imp (e.g. 60% = 0.60)	$Imp = 0.6$
1-5. Determine the Project Total Impervious area, $TIA = A_{project} * Imp$	$TIA = 6$ acres
1-6. Determine the total area from which runoff must be retained, $A_{retain} = TIA - EIA_{allowable}$	$A_{retain} = 5.5$ acres
1-7. Determine pervious runoff coefficient using <u>Table E-1</u> , C_p	$C_p = 0.05$
1-8. Calculate runoff coefficient, $C = 0.95 * imp + C_p (1 - imp)$	$C = 0.59$
1-9. Enter design rainfall depth of the storm, P_i (in)	$P_i = 0.75$ in
1-10. Calculate rainfall depth, $P = P_i / 12$	$P = 0.06$ ft
1-11. Calculate water quality design volume, $SQDV = 43560 * P * A_{retain} * C$	$SQDV = 8,500$ ft ³

Step 2: Determine the design percolation rate

For this design example, the recommended amended filter hydraulic conductivity is used, 2.5 in/hr.

Step 2: Determine the design percolation rate	
2-1. Enter the design saturated hydraulic conductivity of the amended filter media (2.5 in/hr recommended rate), K_{design}	$K_{design} = 2.5$ in/hr

Step 3: Determine bioretention/ planter box area footprint

A bioretention area is designed with two components: (1) temporary storage reservoir to store runoff, and (2) a plant mix filter bed (planting soil mixed with sand content = 70%) through which the stored runoff must percolate to obtain treatment.

Step 3: Calculate Bioretention/Planter Box surface area	
3-1. Enter water quality design volume (ft ³), $SQDV$	$SQDV = 8,500$ ac-ft
3-2. Enter design saturated hydraulic conductivity (in/hr), K_{design}	$K_{design} = 2.5$ in/hr
3-3. Enter ponding depth (max 1.5 ft for Bioretention, 1 ft for Planter Box) above area, d_p	$d_p = 1.5$ ft
3-4. Calculate the drawdown time for the ponded water to filter through media (hours), $t_{ponding} = (d_p/K_{design}) \times 12$	$t_{ponding} = 7.2$ hrs
3-5. Enter the storm duration for routing calculations (use 3 hours unless there is rationale for an alternative), $T_{routing}$	$T_{routing} = 3$ hrs
3-6. Calculate depth of water (ft) filtered by using the minimum of the following two equations: $d_{filtered,1} = (K_{design} \times T_{routing})/12$ $d_{filtered,2} = d_p / 2$	$d_{filtered,1} = 0.63$ ft $d_{filtered,2} = 0.75$ ft
3-7 Enter the resultant depth (the minimum of the two calculated above), $d_{filtered}$	$d_{filtered} = 0.63$ ft
3-8. Calculate the infiltrating surface area as follows (ft ²): $A_{req} = SQDV/(d_p + d_{filtered})$	$A_{req} = 4,000$ ft ²

Step 4: Calculate Bioretention Area Total Footprint

For this design example, a natural-shaped bioretention area is assumed, with 3:1 side slopes. To calculate the total footprint, the side slopes would be added to the design geometry.

Step 5: Calculate filter longitudinal underdrain collection pipe

All underdrain pipes must be 6 inches or greater in diameter to facilitate cleaning.

Step 5: Calculate underdrain system (required for planter box)	
To calculate the underdrain system capacity, continue through steps 5-1 to 5-7. If you don't need to calculate the underdrain capacity, skip this step.	
5-1. Calculated filtered flow rate to be conveyed by the longitudinal drain pipe (cfs), $Q_f = K_{design} A_{req}/43,200$	$Q_f = 0.085$ cfs
5-2. Enter minimum slope for energy gradient, S_e	$S_e = 0.005$
5-3. Enter Hazen-Williams coefficient for plastic, C_{HW}	$C_{HW} = 140$
5-4. Enter pipe diameter (min 6 in), D	$D = 6$ in
5-5. Calculate pipe hydraulic radius (ft), $R_h = D/48$	$R_h = 0.13$ ft
5-6. Calculate velocity at the outlet of the pipe (ft/s), $V_p = 1.318C_{HW}R_h^{0.63}S_e^{0.54}$	$V_p = 2.9$ ft/s
5-7. Calculate pipe capacity (cfs), $Q_{cap} = 0.25\pi(D/12)^2V_p$	$Q_{cap} = 0.57$ cfs

E.6 VEG-3 Vegetated Swale

Sizing Methodology

The flow capacity of a vegetated swale is a function of the longitudinal slope (parallel to flow), the resistance to flow (i.e. Manning's roughness), and the cross sectional area. The cross section is normally approximately trapezoidal and the area is a function of the bottom width and side slopes. The flow capacity of vegetated swales should be such that the design water quality flow rate will not exceed a flow depth of 2/3 the height of the vegetation within the swale or 4 inches at the water quality design flow rate. Once design criteria have been selected, the resulting flow depth for the design water quality design flow rate is checked. If the depth restriction is exceeded, swale parameters (e.g. longitudinal slope, width) are adjusted to reduce the flow depth.

Procedures for sizing vegetated swales are summarized below. A vegetated swale sizing worksheet and example are also provided.

Step 1: Select design flows

The swale sizing is based on the stormwater quality design flow SQDF (see [Section E.1](#)).

Step 2: Calculate swale bottom width

The swale bottom width is calculated based on Manning's equation for open-channel flow. This equation can be used to calculate discharges as follows:

$$Q = \frac{1.49AR^{1.67}S^{0.5}}{n} \quad \text{(Equation E-29)}$$

Where:

Q	=	flow rate (cfs)
n	=	Manning's roughness coefficient (unitless)
A	=	cross-sectional area of flow (ft ²)
R	=	hydraulic radius (ft) = area divided by wetted perimeter
S	=	longitudinal slope (ft/ft)

For shallow flow depths in swales, channel side slopes are ignored in the calculation of bottom width. Use the following equation (a simplified form of Manning's formula) to estimate the swale bottom width:

$$b = \frac{SQDF * n_{wq}}{1.49 y^{1.67} s^{0.5}} \quad \text{(Equation E-30)}$$

Where:

b	=	bottom width of swale (ft)
$SQDF$	=	stormwater quality design flow (cfs)
n_{wq}	=	Manning's roughness coefficient for shallow flow conditions = 0.2 (unitless)
y	=	design flow depth (ft)
s	=	longitudinal slope (along direction of flow) (ft/ft)

Proceed to Step 3 if the bottom width is calculated to be between 2 and 10 feet. A minimum 2-foot bottom width is required. Therefore, if the calculated bottom width is less than 2 feet, increase the width to 2 feet and recalculate the design flow depth y using the Equation 4-13, where Q_{wq} , n_{wq} , and s are the same values as used above, but $b = 2$ feet.

The maximum allowable bottom width is 10 feet; therefore if the calculated bottom width exceeds 10 feet, then one of the following steps is necessary to reduce the design bottom width:

- 1) Increase the longitudinal slope (s) to a maximum of 6 feet in 100 feet (0.06 feet per foot).
- 2) Increase the design flow depth (y) to a maximum of 4 inches.
- 3) Place a divider lengthwise along the swale bottom (Figure 3-1) at least three-quarters of the swale length (beginning at the inlet), without compromising the design flow depth and swale lateral slope requirements. Swale width can be increased to an absolute maximum of 16 feet if a divider is provided.

Step 3: Determine design flow velocity

To calculate the design flow velocity through the swale, use the flow continuity equation:

$$V_{wq} = SQDF / A_{wq} \quad \text{(Equation E-31)}$$

Where:

V_{wq}	=	design flow velocity (fps)
$SQDF$	=	stormwater quality design flow (cfs)

$$A_{wq} = by + Zy^2 = \text{cross-sectional area (ft}^2\text{) of flow at design depth, where } Z = \text{side slope length per unit height (e.g., } Z = 3 \text{ if side slopes are 3H:1V)}$$

If the design flow velocity exceeds 1 foot per second, go back to Step 2 and modify one or more of the design parameters (longitudinal slope, bottom width, or flow depth) to reduce the design flow velocity to 1 foot per second or less. If the design flow velocity is calculated to be less than 1 foot per second, proceed to Step 4. *Note: It is desirable to have the design velocity as low as possible, both to improve treatment effectiveness and to reduce swale length requirements.*

Step 4: Calculate swale length

Use the following equation to determine the necessary swale length to achieve a hydraulic residence time of at least 10 minutes (600 seconds):

$$L = 60t_{hr}V_{wq} \quad \text{(Equation E-32)}$$

Where:

L = minimum allowable swale length (ft)

t_{hr} = hydraulic residence time (min)

V_{wq} = design flow velocity (fps)

The minimum swale length is 100 feet; therefore, if the swale length is calculated to be less than 100 feet, increase the length to a minimum of 100 feet, leaving the bottom width unchanged. If a larger swale can be fitted on the site, consider using a greater length to increase the hydraulic residence time and improve the swale's pollutant removal capability. If the calculated length is too long for the site, or if it would cause layout problems, such as encroachment into shaded areas, proceed to Step 5 to further modify the layout. If the swale length can be accommodated on the site (meandering may help), proceed to Step 6.

Step 5: Adjust swale layout to fit on site

If the swale length calculated in Step 4 is too long for the site, the length can be reduced (to a minimum of 100 feet) by increasing the bottom width up to a maximum of 16 feet, as long as the 10 minute retention time is retained. However, the length cannot be increased in order to reduce the bottom width because Manning's depth-velocity-flow rate relationships would not be preserved. If the bottom width is increased to greater than 10 feet, a low flow dividing berm is needed to split the swale cross section in half to prevent channelization.

Length can be adjusted by calculating the top area of the swale and providing an equivalent top area with the adjusted dimensions.

- 1) Calculate the swale treatment top area based on the swale length calculated in Step 4:

$$A_{top} = (b_i + b_{slope})L_i \quad \text{(Equation E-33)}$$

Where:

A_{top} = top area (ft²) at the design treatment depth

b_i = bottom width (ft) calculated in Step 2

b_{slope} = the additional top width (ft) above the side slope for the design water depth (for 3:1 side slopes and a 4-inch water depth, $b_{slope} = 2$ feet)

L_i = initial length (ft) calculated in Step 4

- 2) Use the swale top area and a reduced swale length L_f to increase the bottom width, using the following equation:

$$L_f = A_{top} / (b_f + b_{slope}) \quad \text{(Equation E-34)}$$

Where:

L_f = reduced swale length (ft)

b_f = increased bottom width (ft).

- 3) Recalculate V_{wq} according to Step 3 using the revised cross-sectional area A_{wq} based on the increased bottom width b_f . Revise the design as necessary if the design flow velocity exceeds 1 foot per second.
- 4) Recalculate to assure that the 10 minute retention time is retained.

Step 6: Provide conveyance capacity for flows higher than SQDF

Vegetated swales may be designed as flow-through channels that convey flows higher than the water quality design flow rate, or they may be designed to incorporate a high-flow bypass upstream of the swale inlet. A high-flow bypass usually results in a smaller swale size. If a high-flow bypass is provided, this step is not needed. If no high-flow bypass is provided, proceed with the procedure below. Flow splitter structure design is described in Appendix G.

- 1) Check the swale size to determine whether the swale can convey the flood control design storm peak flows (Refer to the Ventura County Hydrology Manual, 2006).
- 2) The peak flow velocity of the flood control design storm (e.g., flood control design storm – see Ventura County Hydrology Manual, 2006)) must be less than 3.0 feet per second. If this velocity exceeds 3.0 feet per second, return to Step 2 and

increase the bottom width or flatten the longitudinal slope as necessary to reduce the flood control design storm peak flow velocity to 3.0 feet per second or less. If the longitudinal slope is flattened, the swale bottom width must be recalculated (Step 2) and must meet all design criteria.

Sizing Worksheet

Step 1: Determine water quality design flow	
1-1. Enter Project area (acres), $A_{project}$	$A_{design} =$ acres
1-2. Enter impervious fraction, Imp (e.g. 60% = 0.60)	$Imp =$
1-3. Determine pervious runoff coefficient using Table E-1, C_p	$C_p =$
1-4. Calculate runoff coefficient, $C = 0.95*imp + C_p (1-imp)$	$C =$
1-5. Enter design rainfall intensity (in/hr), i	$i =$ in/hr
1-6. Calculate water quality design flow (cfs), $SQDF = CiA$	$SQDF =$ cfs
Step 2: Calculate swale bottom width	
2-1. Enter water quality design flow (cfs), $SQDF$	$SQDF =$ cfs
2-2. Enter Manning's roughness coefficient for shallow flow conditions, $n_{wq} = 0.2$	$n_{wq} =$
2-3. Calculate design flow depth (ft), y	$y =$ ft
2-4. Enter longitudinal slope (ft/ft) (along direction of flow), s	$s =$ ft/ft
2-5. Calculate bottom width of swale (ft), $b = (SQDF*n_{wq})/(1.49y^{1.67}s^{0.5})$	$b =$ ft
2-6. If b is between 2 and 10 feet, go to Step 3	
2-7. If b is less than 2 ft, assume $b = 2$ ft and recalculate flow depth, $y = ((SQDF*n_{wq})/(2.98 s^{0.5}))^{0.6}$	$y =$ ft

<p>2-8. If b is greater than 10 ft, one of the following design adjustments must be made (recalculate variables as necessary):</p> <ul style="list-style-type: none"> • Increase the longitudinal slope to a maximum of 0.06 ft/ft. • Increase the design flow depth to a maximum of 4 in (0.33 ft). • Place a divider lengthwise along the swale bottom (Figure 3-1) at least three-quarters of the swale length (beginning at the inlet). Swale width can be increased to an absolute maximum of 16 feet if a divider is provided. 	
Step 3: Determine design flow velocity	
<p>3-1. Enter side slope length per unit height (H:V) (e.g. 3 if side slopes are 3H :1V), Z</p>	$Z =$
<p>3-2. Enter bottom width of swale (ft), b</p>	$b =$ ft
<p>3-3. Enter design flow depth (ft), y</p>	$y =$ ft
<p>3-4. Calculate the cross-sectional area of flow at design depth (ft²),</p> $A_{wq} = by + Zy^2$	$A_{wq} =$ ft ²
<p>3-5. Calculate design flow velocity (ft/s), $V_{wq} = SQDF / A_{wq}$</p>	$V_{wq} =$ ft/s
<p>3-6. If the design flow velocity exceeds 1 ft/s, go back to Step 2 and change one or more of the design parameters to reduce the design flow velocity. If design flow velocity is less than 1 ft/s, proceed to Step 4.</p>	
Step 4: Calculate swale length	
<p>4-1. Enter hydraulic residence time (minutes, minimum 10 min), t_{hr}</p>	$t_{hr} =$ min
<p>4-2. Calculate swale length (ft), $L = 60t_{hr}V_{wq}$</p>	$L =$ ft

<p>4-3. If L is too long for the site, proceed to Step 5 to adjust the swale layout</p> <p>If L is greater than 100 ft and will fit within the constraints of the site, skip to Step 6</p> <p>If L is less than 100 ft, increase the length to a minimum of 100 ft, leaving the bottom width unchanged, and skip to Step 6</p>	
<p>Step 5: Adjust swale layout to fit within site constraints</p>	
<p>5-1. Enter the bottom width calculated in Step 2 (ft), $b_i = b$</p>	<p>$b_i =$ ft</p>
<p>5-2. Enter design flow depth (ft), y</p>	<p>$y =$ ft</p>
<p>5-3. Enter the swale side slope ratio (H:V), Z</p>	<p>$Z =$ ft:ft</p>
<p>5-4. Enter the additional top width above the side slope for the design water depth (ft), $b_{slope} = 2Zy$</p>	<p>$b_{slope} =$ ft</p>
<p>5-5. Enter the initial length calculated in Step 4 (ft), $L_i = L$</p>	<p>$L_i =$ ft</p>
<p>5-6. Calculate the top area at the design treatment depth (ft²), $A_{top} = (b_i + b_{slope}) \times L_i$</p>	<p>$A_{top} =$ ft²</p>
<p>5-7. Choose a reduced swale length based on site constraints (ft), L_f</p>	<p>$L_f =$ ft</p>
<p>5-8. Calculate the increased bottom width (ft),</p> <p>$b_f = (A_{top}/L_f) - b_{slope}$</p>	<p>$b_f =$ ft</p>
<p>5-9. Recalculate the cross-sectional area of flow at design depth (ft²), $A_{wq,f} = b_f y + Zy^2$</p>	<p>$A_{wq,f} =$ ft²</p>
<p>5-10. Recalculate design flow velocity (ft/s),</p> <p>$V_{wq} = SQDF / A_{wq}$</p> <p>Revise design as necessary if design flow velocity exceeds 1 ft/s.</p>	<p>$V_{wq} =$ ft/s</p>

<p>5-11. Recalculate the hydraulic residence time (min),</p> $t_{hr} = L_f / (60V_{wq})$ <p>Ensure that t_{hr} is greater or equal to 10 minutes.</p>	<p>$t_{hr} =$ min</p>
<p>5-12. When V_{wq} and t_{hr} are recalculated to meet requirements, proceed to Step 6.</p>	
<p>Step 6: Provide conveyance capacity for flows higher than SQDF (if swale is on-line)</p>	
<p>6-1. If the swale already includes a high-flow bypass to convey flows higher than the water quality design flow rate, skip this step and verify that all parameters meet design requirements to complete sizing</p>	
<p>6-2. If swale does not include a high-flow bypass, determine that the swale can convey flood control design storm peak flows. Calculate the capital peak flow velocity per Ventura County requirements (ft/s), V_p</p>	<p>$V_p =$ ft/s</p>
<p>6-3. If $V_p > 3.0$ feet per second, return to Step 2 and increase the bottom width or flatten the longitudinal slope as necessary to reduce the flood control design storm peak flow velocity to 3.0 feet per second or less. If the longitudinal slope is flattened, the swale bottom width must be recalculated (Step 2) and must meet all design criteria.</p>	

Design Example

Step 1: Determine water quality design Flow

For this design example, a 10-acre site with Type 4 soil and 60% total imperviousness is considered. Flow-based sizing Method 1 as described in A Manual for the Standard Urban Storm Water Mitigation Plan, LACDPW, September 2002 (or as amended) is assumed. Therefore, the design intensity is 0.2 in/hr.

Step 1: Determine water quality design flow	
1-1. Enter Project area (acres), $A_{project}$	A = 10 acres
1-2. Enter impervious fraction, Imp (e.g. 60% = 0.60)	Imp = 0.60
1-3. Determine pervious runoff coefficient using Table E-1, C_p	C_p = 0.05
1-4. Calculate runoff coefficient, $C = 0.95*imp + C_p(1-imp)$	C = 0.59
1-5. Enter design rainfall intensity (in/hr), i	i = 0.2 in/hr
1-6. Calculate water quality design flow (cfs), $SQDF = CiA$	$SQDF =$ 1.18 cfs

Step 2: Calculate Swale Bottom Width

The swale bottom width is calculated based on Manning's equation. The grass height in the swale will be maintained at 6-inches. The design flow depth is assumed to be 2/3 of the grass height, or 4 inches (0.33 ft). The default Manning's roughness coefficient is assumed appropriate for expected vegetation density and design depth. The slope was assumed to be 0.04.

Step 2: Calculate swale bottom width	
2-1. Enter water quality design flow (cfs), $SQDF$	$SQDF =$ 1.18 cfs
2-2. Enter Manning's roughness coefficient for shallow flow conditions, $n_{wq} = 0.2$	$n_{wq} =$ 0.2
2-3. Calculate design flow depth (ft), y	$y =$ 0.33 ft
2-4. Enter longitudinal slope (along direction of flow) (ft/ft), s	$s =$ 0.04 ft/ft

2-5. Calculate bottom width of swale (ft), $b = Q_{wq}n_{wq} / 1.49y^{1.67}S^{0.5}$	b = 5.0 ft
2-6. If <i>b</i> is between 2 and 10 feet, go to Step 3	
2-7. If <i>b</i> is less than 2 ft, assume <i>b</i> = 2 ft and recalculate flow depth, $y = (Q_{wq}n_{wq} / 2.98S^{0.5})^{0.6}$	Not applicable
2-8. If <i>b</i> is greater than 10 ft, one of the following design adjustments must be made (and recalculate as necessary): Increase the longitudinal slope to a maximum of 0.06 ft/ft. Increase the design flow depth to a maximum of 4 in (0.33 ft). Place a divider lengthwise along the swale bottom (Figure 3-1) at least three-quarters of the swale length (beginning at the inlet). Swale width can be increased to an absolute maximum of 16 feet if a divider is provided.	Not applicable

Step 3: Determine Design Flow Velocity

For this design example, it is assumed the side slopes will be designed as 3H: 1V, so Z = 3.

Step 3: Determine design flow velocity	
3-1. Enter side slope length per unit height (H:V) (e.g. 3 if side slopes are 3H :1V), <i>Z</i>	Z = 3
3-2. Enter bottom width of swale (ft), <i>b</i>	b = 5.0 ft
3-3. Enter design flow depth (ft), <i>y</i>	y = 0.33 ft
3-4. Calculate the cross-sectional area of flow at design depth (ft ²), $A_{wq} = by + Zy^2$	$A_{wq} = 2.0 \text{ ft}^2$
3-5. Calculate design flow velocity (ft/s), $V_{wq} = SQDF / A_{wq}$	$V_{wq} = 0.59 \text{ ft/s}$
3-6. If the design flow exceeds 1 ft/s, go back to Step 2 and change one or more of the design parameters to reduce the design flow velocity. If design flow velocity is less than 1 ft/s, proceed to Step 4.	

Step 4: Calculate Swale Length

Using the design flow velocity and a minimum residence time of 10 minutes, the length of the swale is calculated as follows. The swale length must be a minimum of 100 ft.

Step 4: Calculate swale length	
4-1. Enter hydraulic residence time (min 10 min), t_{hr} (min)	$t_{hr} = 10 \text{ min}$
4-2. Calculate swale length, $L = 60t_{hr}V_{wq}$	$L = 354 \text{ ft}$
4-3. If L is too long for the site, proceed to Step 5 to adjust the swale layout If L is greater than 100 ft and will fit within the constraints of the site, skip to Step 6 If L is less than 100 ft, increase the length to a minimum of 100 ft, leaving the bottom width unchanged, and skip to Step 6	Not Applicable

Site constraints only allow a swale length of 300 feet. Therefore proceed to Step 5 to adjust the swale length.

Step 5: Adjust Swale Layout to Fit Within Site Constraints

To adjust swale length to 300 feet, the bottom width needs to be increased (up to a maximum of 16 ft if a divider is provided).

Step 5: Adjust swale layout to fit within site constraints	
5-1. Enter the bottom width calculated in Step 2 (ft), $b_i = b$	$b_i = 5.0 \text{ ft}$
5-2. Enter design flow depth (ft), y	$y = 0.33 \text{ ft}$
5-3. Enter the swale side slope ratio (H:V), Z	$Z = 3 \text{ ft:ft}$
5-4. Enter the additional top width above the side slope for the design water depth (ft), $b_{slope} = 2Zy$	$b_{slope} = 2 \text{ ft}$
5-5. Enter the initial length calculated in Step 4 (ft), $L_i = L$	$L_i = 354 \text{ ft}$
5-6. Calculate the top area at the design treatment depth (ft ²), $A_{top} = (b_i + b_{slope}) \times L_i$	$A_{top} = 2,480 \text{ ft}^2$

5-7. Choose a reduced swale length based on site constraints (ft), L_f	$L_f = 300 \text{ ft}$
5-8. Calculate the increased bottom width (ft), $b_f = (A_{top}/L_f) - b_{slope}$	$b_f = 6.3 \text{ ft}$
5-9. Recalculate the cross-sectional area of flow at design depth (ft ²), $A_{wq,f} = b_f y + Zy^2$	$A_{wq,f} = 2.4 \text{ ft}^2$
5-10. Recalculate design flow velocity (ft/s), $V_{wq} = SQDF / A_{wq}$ Revise design as necessary if design flow velocity exceeds 1 ft/s.	$V_{wq} = 0.49 \text{ ft/s}$
5-11. Recalculate the hydraulic residence time (min), $t_{hr} = L_f / (60V_{wq})$ Ensure that t_{hr} is greater or equal to 10 minutes.	$t_{hr} = 10.2 \text{ min}$
5-12. When V_{wq} and t_{hr} are recalculated to meet requirements, proceed to Step 6.	

Since the new length and width yields V_{wq} and t_{hr} which meet requirements, continue to Step 6.

Step 6: Provide Conveyance Capacity for Flows Higher than SQDF

The swale will be offline such that all flows greater than SQDF will be bypassed.

E.7 VEG-4 Filter Strip

Sizing Methodology

The flow capacity of a vegetated filter strips (filter strips) is a function of the longitudinal slope (parallel to flow), the resistance to flow (e.g., Manning's roughness), and the width and length of the filter strip. The slope shall be small enough to ensure that the depth of water will not exceed 1 inch over the filter strip. Similarly, the flow velocity shall be less than 1 ft/sec. Procedures for sizing filter strips are summarized below. A filter strip sizing example is also provided.

Step 1: Calculate the design flow rate

The design flow is calculated based on the stormwater quality design flow rate, SQDF, as described in [Section E.1](#).

Step 2: Calculate the minimum width

Determine the minimum width (i.e. perpendicular to flow) allowable for the filter strip and design for that width or larger.

$$W_{min} = (SQDF) / (q_{a,min}) \quad \text{(Equation E-35)}$$

Where

- W_{min} = minimum width of filter strip
- $SQDF$ = stormwater quality design flow (cfs)
- $q_{a,min}$ = minimum linear unit application rate, 0.005 cfs/ft

Step 3: Calculate the design flow depth

The design flow depth (d_f) is calculated based on the width and the slope (parallel to the flow path) using a modified Manning's equation as follows:

$$d_f = 12 * [SQDF * n_{wq} / 1.49W_{trib} s^{0.5}]^{0.6} \quad \text{(Equation E-36)}$$

Where:

- d_f = design flow depth (inches)
- $SQDF$ = stormwater quality design flow (cfs)
- W_{trib} = width (perpendicular to flow = width of impervious surface contributing area (ft))
- s = slope (ft/ft) of strip parallel to flow, average over the whole width

n_{wq} = Manning's roughness coefficient (0.25-0.30)

If d_f is greater than 1 inch (0.083 ft), then a shallower slope is required, or a filter strip cannot be used.

Step 4: Calculate the design velocity

The design flow velocity is based on the design flow, design flow depth, and width of the strip:

$$V_{wq} = SQDF / (d_f W_{trib}) \quad \text{(Equation E-37)}$$

Where:

$d_{f,ft}$ = design flow depth (ft) ($d_f/12$)

$SQDF$ = stormwater quality design flow (cfs)

W_{trib} = width (perpendicular to flow = width of impervious surface contributing area (ft))

Step 5: Calculate the desired length of the filter strip

Determine the required length (L) to achieve a desired minimum residence time of 10 minutes using:

$$L = 60t_{hr}V_{wq} \quad \text{(Equation E-38)}$$

Where:

L = minimum allowable strip length (ft)

t_{hr} = hydraulic residence time (s)

V_{wq} = design flow velocity (fps)

Sizing Worksheet

Step 1: Calculate the design flow	
1-1. Enter Project area (acres), $A_{project}$	$A_{design} =$ acres
1-2. Enter impervious fraction, Imp (e.g. 60% = 0.60)	$Imp =$
1-3. Determine pervious runoff coefficient using Table E-1, C_p	$C_p =$
1-4. Calculate runoff coefficient, $C = 0.95*imp + C_p (1-imp)$	$C =$
1-5. Enter design rainfall intensity (in/hr), i	$i =$ in/hr
1-6. Calculate water quality design flow (cfs), $SQDF = CiA$	$SQDF =$ cfs
Step 2: Calculate the minimum width	
2-1. Enter the stormwater quality design flow (cfs), $SQDF$	$SQDF =$ cfs
2-2. Enter the minimum linear unit application rate (0.005 cfs/ft), $q_{a,min}$	$q_{a,min} =$ cfs/ft
2-3. Calculate the minimum width of filter strip (ft), W_{min}	$W_{min} =$ ft
Step 3: Calculate the design flow depth	
3-1. Enter filter strip longitudinal slope, s (ft/ft)	$s =$ ft/ft
3-2. Enter Manning roughness coefficient (0.25-0.30), n_{wq}	$n_{wq} =$
3-3. Enter width of impervious surface contributing area (perpendicular to flow), W (ft)	$W =$ ft

3-4. Calculate average depth of water using Manning equation (inches), $d_f = 12 * [SQDF * n_{wq} / 1.49 W_{trib} s^{0.5}]^{0.6}$	$d_f =$ inches
3-5. If $d_f > 1$ " (0.083 ft), go back step 3-1 and decrease the slope	
3-6. If the slope cannot be changed due to construction constraints, go to step 3-3 and increase the width perpendicular to flow.	
Step 4: Calculate the design velocity	
4-1. Enter depth of water (ft), $d_{fft} = d_f / 12$	$d_f =$ ft
4-2. Enter width of strip (ft), W	$W =$ ft
4-3. Calculate design flow velocity (ft/s), $V_{wq} = SQDF / (d_{fft} W)$	$V_{wq} =$ ft/s
4-4. If the $V_{wq} > 1$ ft/s, go back to step 3-1 and decrease the slope.	
Step 5: Calculate the length of the filter strip	
5-1. Enter desired residence time (minimum 10 minutes), t	$t =$ min
5-2. Enter design flow velocity (ft/s), V_{wq}	$V_{wq} =$ ft/s
5-3. Calculate length of the filter strip (ft), $L = 60tV_{wq}$	$L =$ ft
5-4. If $L < 4$ ft, go to step 3-1 and increase the slope	

Design Example

Step 1: Determine water quality design Flow

For this design example, a 10-acre site with Type 4 soil and 60% total imperviousness is considered. Flow-based sizing Method 1 is used, as described in [Section E.1](#).

Step 1: Calculate the design flow	
1-1. Enter Project area (acres), $A_{project}$	$A_{design} = 10$ acres
1-2. Enter impervious fraction, Imp (e.g. 60% = 0.60)	$Imp = 0.60$
1-3. Determine pervious runoff coefficient using Table E-1, C_p	$C_p = 0.05$
1-4. Calculate runoff coefficient, $C = 0.95 * imp + C_p (1 - imp)$	$C = 0.59$
1-5. Enter design rainfall intensity (in/hr), i	$i = 0.2$ in/hr
1-6. Calculate water quality design flow (cfs), $SQDF = CiA$	$SQDF = 1.18$ cfs

Step 2: Calculate the minimum width of filter strip

Determine the minimum width (i.e. perpendicular to flow) allowable for the filter strip and design for that width or larger.

Step 2: Calculate the minimum width	
2-1. Enter the stormwater quality design flow (cfs), $SQDF$	$SQDF = 1.18$ cfs
2-2. Enter the minimum linear unit application rate (0.005 cfs/ft), $q_{a,min}$	$q_{a,min} = 0.005$ cfs/ft
2-3. Calculate the minimum width of filter strip (ft), $W_{min} = SQDF / q_{a,min}$	$W_{min} = 240$ ft

Step 3: Calculate the Design Flow Depth

A slope of 3% was assumed for the filter strip (2-4% recommended). The design water depth should not exceed 1 inch. For this design example a manning's coefficient of 0.27 was used.

Step 3: Calculate the design flow depth	
3-1. Enter filter strip longitudinal slope, s (ft/ft)	$s = 0.03$ ft/ft
3-2. Enter Manning roughness coefficient (0.25-0.30), n_{wq}	$n_{wq} = 0.27$
3-3. Enter width of strip (=impervious surface contributing area perpendicular to flow), at least W_{min} (ft), W	$W = 240$ ft
3-4. Calculate average depth of water using Manning equation (inches), $d_f = 12 * [SQDF * n_{wq} / 1.49 W s^{0.5}]^{0.6}$	$d_f = 0.51$ in
3-5. If $d_f > 1$ " (0.083 ft), go back step 3-1 and decrease the slope	
3-6. If the slope cannot be changed due to construction constraints, go to step 3-3 and increase the width perpendicular to flow.	

Step 4: Calculate the Design Velocity

The designed flow velocity should not exceed 1 foot/second across the filter strip.

Step 4: Calculate the design velocity	
4-1. Enter depth of water (ft), $d_{f,ft} = d_f / 12$	$d_f = 0.043$ ft
4-2. Enter width of strip (ft), W	$W = 240$ ft
4-3. Calculate design flow velocity (ft/s), $V_{wq} = SQDF / (d_{f,ft} W)$	$V_{wq} = 0.11$ ft/s
4-4. If the $V_{wq} > 1$ ft/s, go back to step 3-1 and decrease the slope.	

Step 5: Calculate the Length of the Filter Strip

The filter strip should be at least 4 feet long (in the direction of flow) and accommodate a minimum residence time of 10 minutes to provide adequate water quality treatment.

Step 5: Calculate the length of the filter strip	
5-1. Enter desired residence time (minimum 10 minutes), t	$t = 10 \text{ min}$
5-2. Enter design flow velocity (ft/s), V_{wq}	$V_{wq} = 0.11 \text{ ft/s}$
5-3. Calculate length of the filter strip (ft), $L = 60tV_{wq}$	$L = 66 \text{ ft}$
5-4. If $L < 4 \text{ ft}$, go to step 3-1 and increase the slope	

E.8 TCM-1 Dry Extended Detention Basin

Sizing Methodology

Dry extended detention (ED) basins are basins designed such that the stormwater quality design volume, SQDV, is detained for 36 to 48 hours. This allows sediment particles and associated pollutants to settle and be removed from stormwater. Procedures for sizing extended detention basins are summarized below. A sizing example is also provided.

Step 1: Calculate the design volume

Dry extended detention facilities shall be sized to capture and treat the water quality design volume (see Section E.1).

Step 2: Calculate the volume of the active basin

The total basin volume shall be increased an additional 20% of the stormwater quality design volume to account for sediment accumulation, at a minimum. If the basin is designed only for water quality treatment then the basin volume would be 120% of the stormwater quality design volume, SQDV. Freeboard is in addition to the total basin volume. Calculate the volume of the active basin, V_a :

$$V_a = 1.20 * \text{SQDV} \quad (\text{Equation E-39})$$

Step 3: Determine detention basin location and preliminary geometry based on site constraints

Based on site constraints, determine the basin geometry and the storage available by developing an elevation-storage relationship for the basin. The cross-sectional geometry across the width of the basin shall be approximately trapezoidal with a maximum side slope of 4:1 (H:V) on interior slopes and 3:1 (H:V) on exterior slopes unless specifically permitted by Ventura County (see Side Slopes below). Shallower side slopes are necessary if the basin is designed to have recreational uses during dry weather conditions.

- 1) Calculate the width of the basin footprint, W_{tot} , as follows:

$$W_{tot} = \frac{A_{tot}}{L_{tot}} \quad (\text{Equation E-40})$$

Where:

A_{tot} = total surface area of the basin footprint (ft²)

L_{tot} = total length of the basin footprint (ft)

- 2) Calculate the length of the active volume surface area including the internal berm but excluding the freeboard, L_{av-tot} :

$$L_{av-tot} = L_{tot} - 2Zd_{fb} \quad \text{(Equation E-41)}$$

Where:

Z = interior side slope as length per unit height

d_{fb} = freeboard depth

- 3) Calculate the width of the active volume surface area including the internal berm but excluding freeboard, W_{av-tot} :

$$W_{av-tot} = W_{tot} - 2Zd_{fb} \quad \text{(Equation E-42)}$$

- 4) Calculate the total active volume surface area including the internal berm and excluding freeboard, A_{av-tot} :

$$A_{av-tot} = L_{av-tot} \times W_{av-tot} \quad \text{(Equation E-43)}$$

- 5) Calculate the area of the berm, A_{berm} :

$$A_{berm} = W_{berm} \times L_{berm} \quad \text{(Equation E-44)}$$

Where:

W_{berm} = width of the internal berm

L_{berm} = length of the internal berm

- 6) Calculate the surface area excluding the internal berm and freeboard, A_{av} :

$$A_{av} = A_{av-tot} - A_{berm} \quad \text{(Equation E-45)}$$

Step 4: Determine Dimensions of Forebay

5-15% of the basin active volume, V_a , is required to be within the active volume of the forebay.

- 1) Calculate the active volume of forebay, V_1 :

$$V_1 = \frac{V_a \times \%V_1}{100} \quad \text{(Equation E-46)}$$

Where:

$\%V_1$ = percent of V_a in forebay (%)

V_a = active volume (ft³)

- 2) Calculate the surface area for the active volume of forebay, A_1 :

$$A_1 = \frac{V_1}{d_1} \quad \text{(Equation E-47)}$$

Where:

d_1 = average depth for the active volume of forebay (ft)

- 3) Calculate the length of forebay, L_1 :

$$L_1 = \frac{A_1}{W_1} \quad \text{(Equation E-48)}$$

Where:

W_1 = width of forebay (ft)

Step 5: Determine Dimensions of Cell 2

Cell 2 will consist of the remainder of the basin's active volume.

- 1) Calculate the active volume of Cell 2, V_2 :

$$V_2 = V_a - V_1 \quad \text{(Equation E-49)}$$

Where:

V_a = total basin active volume (ft³)

V_1 = volume of forebay (ft³)

- 2) Calculate the surface area, A_2 , for the active volume of Cell 2:

$$A_2 = A_{av} - A_1 \quad \text{(Equation E-50)}$$

Where:

A_{av} = basin surface area excluding berm and freeboard (ft²)

A_1 = surface area of forebay (ft²)

- 3) Calculate the average depth, d_2 , for the active volume of Cell 2:

$$d_2 = \frac{V_2}{A_2} \quad \text{(Equation E-51)}$$

- 4) Calculate the length of Cell 2, L_2 :

$$L_2 = \frac{A_2}{W_2} \quad \text{(Equation E-52)}$$

Where:

W_2 = width of Cell 2 (ft)

- 5) Verify that the length-to-width ratio of Cell 2 at half of d_2 is at least 1.5:1 with \geq 2:1 preferred. If the length-to width ratio is less than 1.5:1, modify input parameters until a ratio of at least 1.5:1 is achieved. If the input parameters cannot be modified as a result of site constraints, another site for the basin should be chosen. Calculate the length-to width, LW_{mid2} , ratio of Cell 2 at half of d_2 follows:

$$LW_{mid2} = \frac{L_{mid2}}{W_{mid2}} \quad \text{(Equation E-53)}$$

Where:

$$W_{mid2} = W_2 - Zd_2 \text{ and} \quad \text{(Equation E-54)}$$

$$L_{mid2} = L_2 - Zd_2 \quad \text{(Equation E-55)}$$

W_{mid2} = width of Cell 2 at half of d_2 (ft)

L_{mid2} = length of Cell 2 at half of d_2 (ft)

Z = interior side slope as length per unit height (H:V)

Step 6: Ensure Design Requirements and Site Constraints are achieved

Check design requirements and site constraints. Modify design geometry until requirements are met. If the chosen site for the basin is inadequate to meet the design requirements, choose a new location or alternative treatment BMP.

Step 7: Size Outlet Structure

The total drawdown time for the basin should be 36-48 hours. The outlet structure shall be designed to release the bottom 50% of the detention volume (half-full to empty) over 24-32 hours, and the top half (full to half-full) in 12-16 hours. A primary overflow should be sized to pass the peak flow rate from the developed capital design storm. See Section 6 for outlet structure sizing methodologies.

Step 8: Determine Emergency Spillway Requirements

For online basins, an emergency overflow spillway should be sized to pass flows greater than the design peak runoff discharge rate for the 100-yr, 24-hr storm in order to prevent overtopping of the walls or berms in the event that a blockage of the riser occurs. For offline basins, an emergency spillway or riser should be sized to pass

the 100-yr, 24-hr post-development peak storm water runoff discharge rate directly to the downstream conveyance system or another acceptable discharge point. For sites where the emergency spillway discharges to a steep slope, an emergency overflow riser, in addition to the spillway should be provided.

Sizing Worksheet

Step 1: Determine water quality design volume		
1-1. Enter Project area (acres), $A_{project}$	$A =$	acres
1-2. Enter the maximum allowable percent of the Project area that may be effective impervious area (refer to permit), ranges from 5-30%, $\%_{allowable}$	$\%_{allowable} =$	%
1-3. Determine the maximum allowed effective impervious area (ac), $EIA_{allowable} = (A_{project}) * (\%_{allowable})$	$EIA_{allowable} =$	acres
1-4. Enter Project impervious fraction, Imp (e.g. 60% = 0.60)	$Imp =$	
1-5. Determine the Project Total Impervious area (acres), $TIA = A_{project} * Imp$	$TIA =$	acres
1-6. Determine the total area from which runoff must be retained (acres), $A_{retain} = TIA - EIA_{allowable}$	$A_{retain} =$	acres
1-7. Determine pervious runoff coefficient using <u>Table E-1</u> , C_p	$C_p =$	
1-8. Calculate runoff coefficient, $C = 0.95 * imp + C_p (1 - imp)$	$C =$	
1-9. Enter design rainfall depth of the storm (in), P_i (see Table D-3)	$P_i =$	in
1-10. Calculate rainfall depth (ft), $P = P_i / 12$	$P =$	ft
1-11. Calculate water quality design volume (ft ³), $SQDV = 43560 * C * P * A_{retain}$	$SQDV =$	ft ³
Step 2: Calculate the volume of the active basin		
2-1. Calculate basin active volume (includes water quality design volume + sediment storage volume) (ft ³), $V_a = 1.20 * SQDV$	$V_a =$	ft ³

Step 3: Determine Detention Basin Location and Preliminary Geometry Based on Site Constraints		
3-1. Based on site constraints, determine the basin geometry and the storage available by developing an elevation-storage relationship for the basin. For this simple example, assume a trapezoidal geometry for cell 1 (forebay) and cell 2.		
3-2. Enter the total surface area of the basin footprint based on site constraints (ft ²), A_{tot}	$A_{tot} =$	ft ²
3-3. Enter the length of the basin footprint based on site constraints (ft), L_{tot}	$L_{tot} =$	ft
3-4. Calculate the width of the basin footprint (L:W = 1.5:1 min) (ft), $W_{tot} = A_{tot} / L_{tot}$	$W_{tot} =$	ft
3-5. Enter interior side slope as length per unit height (H:V, min = 3), Z	$Z =$	
3-6. Enter desired freeboard depth (ft), d_{fb} (min: 2 ft on-line; 1 ft offline)	$d_{fb} =$	ft
3-7. Calculate the length of the active volume surface area including the internal berm but excluding freeboard, $L_{av-tot} = L_{tot} - 2Zd_{fb}$	$L_{av-tot} =$	ft
3-8. Calculate the width of the active volume surface area including the internal berm but excluding freeboard, $W_{av-tot} = W_{tot} - 2Zd_{fb}$	$W_{av-tot} =$	ft
3-9. Calculate the total active volume surface area including the internal berm and excluding freeboard, $A_{av-tot} = L_{av-tot} \times W_{av-tot}$	$A_{av-tot} =$	ft ²
3-10. Enter the width of the internal berm (6 ft min), W_{berm}	$W_{berm} =$	ft
3-11. Enter the length of the internal berm (ft), $L_{berm} = W_{av-tot}$	$L_{berm} =$	ft
3-12. Calculate the area of the berm (ft ²), $A_{berm} = W_{berm} \times L_{berm}$	$A_{berm} =$	ft ²
3-13. Calculate the surface area excluding the internal berm and freeboard (ft ²), $A_{av} = A_{av-tot} - A_{berm}$	$A_{av} =$	ft ²

Step 4: Determine Dimensions of forebay	
4-1. Enter the percent of V_a in forebay (5-15% required), $\%V_1$	$\%V_1 =$ %
4-2. Calculate the active volume of forebay, $V_1 = (V_a \cdot \%V_1)/100$	$V_1 =$ ft^3
4-3. Enter a desired average depth for the active volume of forebay, d_1	$d_1 =$ ft
4-4. Calculate the surface area for the active volume of forebay, $A_1 = V_1 / d_1$	$A_1 =$ ft^2
4-5. Enter the width of forebay, $W_1 = W_{av-tot} = L_{berm}$	$W_1 =$ ft
4-6. Calculate the length of forebay (Note: inlet and outlet should be configured to maximize the residence time), $L_1 = A_1 / W_1$	$L_1 =$ ft
Step 5: Determine Dimensions of Cell 2	
5-1. Calculate the active volume of Cell 2, $V_2 = V_a - V_1$	$V_2 =$ ft^3
5-2. Calculate the surface area of the active volume of Cell 2, $A_2 = A_{av} - A_1$	$A_2 =$ ft^2
5-3. Calculate the average depth for the active volume of Cell 2, $d_2 = V_2 / A_2$	$d_2 =$ ft
5-4. Enter the width of Cell 2, $W_2 = W_1 = W_{av-tot} = L_{berm}$	$W_2 =$ ft
5-5. Calculate the length of Cell 2, $L_2 = A_2 / W_2$	$L_2 =$ ft
5-6. Calculate the width of Cell 2 at half of d_2 , $W_{mid2} = W_2 - Zd_2$	$W_{mid2} =$ ft
5-7. Calculate the length of Cell 2 at half of d_2 , $L_{mid2} = L_2 - Zd_2$	$L_{mid2} =$ ft

<p>5-8. Verify that the length-to-width ratio of Cell 2 at half of d_2 is at least 1.5:1 with $\geq 2:1$ preferred. If the length-to-width ratio is less than 1.5:1, modify input parameters until a ratio of at least 1.5:1 is achieved. If the input parameters cannot be modified as a result of site constraints, another site for the basin should be chosen, $LW_{mid2} = L_{mid2} / W_{mid2}$</p>	<p>$LW_{mid2} =$</p>
<p>Step 6: Ensure Design Requirements and Site Constraints are Achieved</p>	
<p>6-1. Check design requirements and site constraints. Modify design geometry until requirements are met. If the chosen site for the basin is inadequate to meet the design requirements, choose a new location or alternative treatment BMP.</p>	
<p>Step 7: Size Outlet Structure</p>	
<p>7-1. The total drawdown time for the basin should be 36-48 hours. The outlet structure shall be designed to release the bottom 50% of the detention volume (half-full to empty) over 24-32 hours, and the top half (full to half-full) in 12-16 hours. A primary overflow should be sized to pass the peak flow rate from the developed capital design storm. See Section 6 for outlet structure sizing methodologies.</p>	
<p>Step 8: Determine Emergency Spillway Requirements</p>	
<p>8-1. For online basins, an emergency overflow spillway should be sized to pass flows greater than the design peak runoff discharge rate for the 100-yr, 24-hr storm in order to prevent overtopping of the walls or berms in the event that a blockage of the riser occurs. For offline basins, an emergency spillway or riser should be sized to pass the 100-yr, 24-hr post-development peak storm water runoff discharge rate directly to the downstream conveyance system or another acceptable discharge point. For sites where the emergency spillway discharges to a steep slope, an emergency overflow riser, in addition to the spillway should be provided.</p>	

Design Example

Step 1: Determine water quality design volume

For this design example, a 10-acre residential development with a 60% total impervious area is considered.

Step 1: Determine water quality design volume	
1-1. Enter Project area (acres), $A_{project}$	$A = 10$ acres
1-2. Enter the maximum allowable percent of the Project area that may be effective impervious area (refer to permit), ranges from 5-30%, $\%_{allowable}$	$\%_{allowable} = 5$
1-3. Determine the maximum allowed effective impervious area (ac), $EIA_{allowable} = (A_{project}) * (\%_{allowable})$	$EIA_{allowable} = 0.5$ acres
1-4. Enter Project impervious fraction, Imp (e.g. 60% = 0.60)	$Imp = 0.6$
1-5. Determine the Project Total Impervious area (acres), $TIA = A_{project} * Imp$	$TIA = 6$ acres
1-6. Determine the total area from which runoff must be retained (acres), $A_{retain} = TIA - EIA_{allowable}$	$A_{retain} = 5.5$ acres
1-7. Determine pervious runoff coefficient using Table E-1 , C_p	$C_p = 0.05$
1-8. Calculate runoff coefficient, $C = 0.95 * imp + C_p (1 - imp)$	$C = 0.59$
1-9. Enter design rainfall depth of the storm (in), P_i (see Table D-3)	$P_i = 0.75$ in
1-10. Calculate rainfall depth (ft), $P = P_i / 12$	$P = 0.06$ ft
1-11. Calculate water quality design volume (ft ³), $SQDV = 43560 * C * P * A_{retain}$	$SQDV = 8,500$ ft ³

Step 2: Calculate Volume of the Active Basin and the Forebay Basin

Step 2: Calculate the design volume of the active basin	
2-1. Calculate basin active design volume (includes water quality design volume + sediment storage volume), $V_a = 1.20 * SQDV$	$V_a = 10,000 \text{ ft}^3$

Step 3: Determine Detention Basin Location and Preliminary Geometry Based on Site Constraints

The detention basin in this example has an internal berm separating the forebay (Cell 1) and the main basin (Cell 2). The internal berm elevation is 2 ft below the elevation of the SUSMP volume within the entire basin. The berm length is equal to the width of the basin when filled to the active design volume.

Step 3: Determine Detention Basin Location and Preliminary Geometry Based on Site Constraints	
3-1. Based on site constraints, determine the basin geometry and the storage available by developing an elevation-storage relationship for the basin. For this simple example, assume a trapezoidal geometry for cell 1 (forebay) and cell 2.	
3-2. Enter the total surface area of the basin footprint based on site constraints, A_{tot}	$A_{tot} = 8,000 \text{ ft}^2$
3-3. Enter the length of the basin footprint based on site constraints, L_{tot} (L:W = 1.5:1 min)	$L_{tot} = 200 \text{ ft}$
3-4. Calculate the width of the basin footprint, $W_{tot} = A_{tot} / L_{tot}$	$W_{tot} = 40 \text{ ft}$
3-5. Enter interior side slope as length per unit height (min = 3), Z	$Z = 3$
3-6. Enter desired freeboard depth, d_{fb} (min: 2 ft on-line; 1 ft offline)	$d_{fb} = 2 \text{ ft}$
3-7. Calculate the length of the active volume surface area including the internal berm but excluding freeboard, $L_{av-tot} = L_{tot} - 2Zd_{fb}$	$L_{av-tot} = 188 \text{ ft}$

Step 3: Determine Detention Basin Location and Preliminary Geometry Based on Site Constraints	
3-8. Calculate the width of the active volume surface area including the internal berm but excluding freeboard, $W_{av-tot} = W_{tot} - 2Zd_{fb}$	$W_{av-tot} = 28 \text{ ft}$
3-9. Calculate the total active volume surface area including the internal berm and excluding freeboard, $A_{av-tot} = L_{av-tot} \cdot W_{av-tot}$	$A_{av-tot} = 5,300 \text{ ft}^2$
3-10. Enter the width of the internal berm (6 ft min), W_{berm}	$W_{berm} = 6 \text{ ft}$
3-11. Enter the length of the internal berm, $L_{berm} = W_{av-tot}$	$L_{berm} = 28 \text{ ft}$
3-12. Calculate the area of the berm, $A_{berm} = W_{berm} \cdot L_{berm}$	$A_{berm} = 170 \text{ ft}^2$
3-13. Calculate the surface area excluding the internal berm and freeboard, $A_{av} = A_{av-tot} - A_{berm}$	$A_{av} = 5,130 \text{ ft}^2$

Step 4: Calculate Dimensions of Cell 1

Calculate the dimensions of the forebay (Cell 1) based on the active design volume for Cell 1 (25% of V_a) and a desired average depth, d_1 . The width of the forebay, W_1 , is equivalent to the length of the berm, L_{berm} , and the width of Cell 2, W_2 .

Step 4: Determine Dimensions of forebay	
4-1. Enter the percent of V_a in forebay (5-15% required), $\%V_1$	$\%V_1 = 25 \%$
4-2. Calculate the active volume of forebay (including sediment storage), $V_1 = (V_a \cdot \%V_1)/100$	$V_1 = 2,500 \text{ ft}^3$
4-3. Enter a desired average depth for the active volume of forebay, d_1	$d_1 = 5 \text{ ft}$
4-4. Calculate the surface area for the active volume of forebay, $A_1 = V_1 / d_1$	$A_1 = 500 \text{ ft}^2$

4-5. Enter the width of forebay, $W_1 = W_{wq-tot} = L_{berm}$	$W_1 = 28 \text{ ft}$
4-6. Calculate the length of forebay (Note: inlet and outlet should be configured to maximize the residence time), $L_1 = A_1 / W_1$	$L_1 = 18 \text{ ft}$

Step 5: Calculate the Dimensions of Cell 2

Calculate the dimensions of the main basin (Cell 2) based on the active design volume for Cell 2 and a desired average depth, d_2 . A calculation of the length, L_{mid2} , and width, W_{mid2} , at half basin depth, d_2 , is conducted in order to verify that the length-to-width ratio at half d_2 is greater than 1.5:1.

Step 5: Calculate the dimensions of Cell 2	
5-1. Calculate the active volume of Cell 2, $V_2 = V_a - V_1$	$V_2 = 7,500 \text{ ft}^3$
5-2. Calculate the surface area of the active volume of Cell 2, $A_2 = A_{av} - A_1$	$A_2 = 4,630 \text{ ft}^2$
5-3. Calculate the average depth of the active volume of Cell 2, $d_2 = V_2 / A_2$	$d_2 = 1.6 \text{ ft}$
5-4. Enter the width of Cell 2, $W_2 = W_1 = W_{av-tot} = L_{berm}$	$W_2 = 28 \text{ ft}$
5-5. Calculate the length of Cell 2, $L_2 = A_2 / W_2$	$L_2 = 166 \text{ ft}$
5-6. Calculate the width of Cell 2 at half of d_2 , $W_{mid2} = W_2 - Zd_2$	$W_{mid2} = 23 \text{ ft}$
5-7. Calculate the length of Cell 2 at half of d_2 , $L_{mid2} = L_2 - Zd_2$	$L_{mid2} = 161 \text{ ft}$
5-8. Verify that the length-to-width ratio of Cell 2 at half of d_2 is at least 1.5:1 with $\geq 2:1$ preferred. If the length-to-width ratio is less than 1.5:1, modify input parameters until a ratio of at least 1.5:1 is achieved. If the input parameters cannot be modified as a result of site constraints, another site for the basin should be chosen, $LW_{mid2} = L_{mid2} / W_{mid2}$	$LW_{mid2} = 7$

Step 6: Ensure Design Requirements and Site Constraints are Achieved

Check design requirements and site constraints. Modify design geometry until requirements are met. If the chosen site for the basin is inadequate to meet the design requirements, choose a new location or an alternative treatment BMP.

Step 7: Size Outlet Structure

The total drawdown time for the basin should be 36-48 hours. The outlet structure shall be designed to release the bottom 50% of the detention volume (half-full to empty) over 24-32 hours, and the top half (full to half-full) in 12-16 hours. A primary overflow should be sized to pass the peak flow rate from the developed capital design storm. See Section 6 for outlet structure sizing methodologies.

Step 8: Determine Emergency Spillway Requirements

For online basins, an emergency overflow spillway should be sized to pass flows greater than the design peak runoff discharge rate for the 100-yr, 24-hr storm in order to prevent overtopping of the walls or berms in the event that a blockage of the riser occurs. For offline basins, an emergency spillway or riser should be sized to pass the 100-yr, 24-hr post-development peak storm water runoff discharge rate directly to the downstream conveyance system or another acceptable discharge point. For sites where the emergency spillway discharges to a steep slope, an emergency overflow riser, in addition to the spillway should be provided.

E.9 TCM-2 Wet Detention Basin

Sizing Methodology

Wet Detention basins may be designed with or without extended detention above the permanent pool. The extended detention portion of the wet detention basin above the permanent pool, if provided, functions like a dry extended detention (ED) basin (see [VEG-5: Dry Extended Detention Basin](#)). If there is no extended detention provided, wet detention basins shall be sized to provide a minimum wet pool volume equal to the stormwater quality design volume plus an additional 5% for sediment accumulation. If extended detention is provided above the permanent pool, the sizing is dependent of the functionality of the basin; the basin may function as water quality treatment only or water quality plus peak flow attenuation.

If and the basin is designed for water quality treatment only, then the permanent pool volume shall be a minimum of 10 percent of the stormwater quality design volume and the surcharge volume (above the permanent pool) shall make up the remaining 90 percent. If extended detention is provided above the permanent pool and the basin is designed for water quality treatment and peak flow attenuation, then the permanent pool volume shall be equal to the water quality treatment volume, and the surcharge volume shall be sized to attenuate peak flows in order to meet the peak runoff discharge requirements. The extended detention portion of the wet detention basin above the permanent pool, if provided, functions like a dry extended detention (ED) basin (see [VEG-5: Dry Extended Detention Basin](#)).

Step 1: Calculate the design volume

Wet detention basins shall be sized with a permanent pool volume equal to the SQDV volume (see [Section 2](#) and Appendix E).

Step 2: Determine the active design volume for the wet detention basin without extended detention

The active volume of the wet detention basin, V_a , shall be equal to the SQFV plus an additional 5% for sediment accumulation.

$$V_a = 1.05 \times SQDV \quad \text{(Equation E-56)}$$

Step 3: Determine pond location and preliminary geometry based on site constraints

Based on site constraints, determine the pond geometry and the storage available by developing an elevation-storage relationship for the pond. Note that a more natural geometry may be used and is in many cases recommended; the preliminary basin geometry calculations should be used for sizing purposes only.

- 1) Calculate the width of the pond footprint, W_{tot} , as follows:

$$W_{tot} = \frac{A_{tot}}{L_{tot}} \quad \text{(Equation E-57)}$$

Where:

A_{tot} = total surface area of the pond footprint (ft²)

L_{tot} = total length of the pond footprint (ft)

- 7) Calculate the length of the active volume surface area including the internal berm but excluding the freeboard, L_{av-tot} :

$$L_{av-tot} = L_{tot} - 2Zd_{fb} \quad \text{(Equation E-58)}$$

Where:

Z = interior side slope as length per unit height

d_{fb} = freeboard depth

- 8) Calculate the width of the active volume surface area including the internal berm but excluding freeboard, W_{av-tot} :

$$W_{av-tot} = W_{tot} - 2Zd_{fb} \quad \text{(Equation E-59)}$$

- 9) Calculate the total active volume surface area including the internal berm and excluding freeboard, A_{av-tot} :

$$A_{av-tot} = L_{av-tot} \times W_{av-tot} \quad \text{(Equation E-60)}$$

- 10) Calculate the area of the berm, A_{berm} :

$$A_{berm} = W_{berm} \times L_{berm} \quad \text{(Equation E-61)}$$

Where:

W_{berm} = width of the internal berm

L_{berm} = length of the internal berm

- 11) Calculate the active volume surface area excluding the internal berm and freeboard, A_{wq} :

$$A_{wq} = A_{wq-tot} - A_{berm} \quad \text{(Equation E-62)}$$

Step 4: Determine Dimensions of Forebay

The wet detention basin shall be divided into two cells separated by a berm or baffle. The forebay shall contain between 5 and 10 percent of the total volume. The berm or

baffle volume shall not count as part of the total volume. Calculate the active volume of forebay, V_1 :

$$V_1 = \frac{V_a \times \%V_1}{100} \quad (\text{Equation E-63})$$

Where:

$\%V_1$ = percent of SQDV in forebay (%)

- 1) Calculate the surface area for the active volume of forebay, A_1 :

$$A_1 = \frac{V_1}{d_1} \quad (\text{Equation E-64})$$

Where:

d_1 = average depth for the active volume of forebay (ft)

- 2) Calculate the length of forebay, L_1 . Note, inlet and outlet should be configured to maximize the residence time.

$$L_1 = \frac{A_1}{W_1} \quad (\text{Equation E-65})$$

Where:

W_1 = width of forebay (ft), $W_1 = W_{av-tot} = L_{berm}$

Step 5: Determine Dimensions of Cell 2

Cell 2 will consist of the remainder of the basin's active volume.

- 3) Calculate the active volume of Cell 2, V_2 :

$$V_2 = V_a - V_1 \quad (\text{Equation E-66})$$

- 4) The minimum wetpool surface area includes 0.3 acres of wetpool per acre-foot of permanent wetpool volume. Calculate A_{min2} :

$$A_{min2} = (V_2 \times 0.3 \frac{\text{acres}}{\text{acre-foot}}) \quad (\text{Equation E-67})$$

- 5) Calculate the actual wetpool surface area, A_2 :

$$A_2 = A_{av} - A_1 \quad (\text{Equation E-68})$$

Verify that A_2 is greater than A_{min2} . If A_2 is less than A_{min2} , then modify input parameters to increase A_2 until it is greater than A_{min2} . If site constraints limit this criterion, then another site for the pond should be chosen.

- 6) Calculate the top length of Cell 2, L_2 :

$$L_2 = \frac{A_2}{W_2} \quad \text{(Equation E-69)}$$

Where:

W_2 = width of Cell 2 (ft), $W_2 = W_1 = W_{wq-tot} = L_{berm}$

- 7) Verify that the length-to-width ratio of Cell 2 is at least 1.5:1 with $\geq 2:1$ preferred. If the length-to-width ratio is less than 1.5:1, modify input parameters until a ratio of at least 1.5:1 is achieved. If the input parameters cannot be modified as a result of site constraints, another site for the pond should be chosen.

$$LW_2 = \frac{L_2}{W_2} \quad \text{(Equation E-70)}$$

- 8) Calculate the emergent vegetation surface area, A_{ev} :

$$A_{ev} = \frac{A_2 \bullet \%A_{ev}}{100} \quad \text{(Equation E-71)}$$

Where:

$\%A_{ev}$ = percent of surface area that will be planted with emergent vegetation

- 9) Calculate the volume of the emergent vegetation shallow zone (1.5 – 3 ft), V_{ev} :

$$V_{ev} = A_{ev} \bullet d_{ev} \quad \text{(Equation E-72)}$$

Where:

d_{ev} = average depth of the emergent vegetation shallow zone (1.5 – 3 ft)

- 10) Calculate the length of the emergent vegetation shallow zone, L_{ev} :

$$L_{ev} = \frac{A_{ev}}{W_{ev}} \quad \text{(Equation E-73)}$$

Where:

W_{ev} = width of the emergent vegetation shallow zone (ft), $W_{ev} = W_2$

- 11) Calculate the volume of the deep zone, V_{deep} :

$$V_{deep} = V_2 - V_{ev} \quad \text{(Equation E-74)}$$

- 12) Calculate the surface area of the deep (>3 ft) zone, A_{deep} :

$$A_{deep} = A_2 - A_{ev} \quad \text{(Equation E-75)}$$

13) Calculate the average depth of the deep zone (4-8 ft), d_{deep} :

$$d_{deep} = \frac{V_{deep}}{A_{deep}} \quad \text{(Equation E-76)}$$

14) Calculate length of the deep zone, L_{deep} :

$$L_{deep} = \frac{A_{deep}}{W_{deep}} \quad \text{(Equation E-77)}$$

Where:

W_{deep} = width of the deep zone (ft), $W_{deep} = W_2$

Step 6: Ensure design requirements and site constraints are achieved

Check design requirements and site constraints. Modify design geometry until requirements are met. If the chosen site for the basin is inadequate to meet the design requirements, choose a new location for the BMP.

Step 7: Size Outlet Structure

For extended detention wet detention basin, outlet structures shall be designed to provide 12 to 48 hour emptying time for the water quality volume above the permanent pool.

The basin outlet pipe shall be sized, at a minimum, to pass flows greater than the stormwater quality design peak flow for off-line basins or flows greater than the peak runoff discharge rate for the 100-year, 24-hr design storm for on-line basins.

Step 8: Determine Emergency Spillway Requirements

For online basins, an emergency overflow spillway should be sized to pass flows greater than the design peak runoff discharge rate for the 100-yr, 24-hr storm to prevent overtopping of the walls or berms in the event that a blockage of the riser occurs. For offline basins, an emergency spillway or riser should be sized to pass the water quality design storm. For sites where the emergency spillway discharges to a steep slope, an emergency overflow riser, in addition to the spillway should be provided.

Sizing Worksheet

Step 1: Determine water quality design volume	
1-1. Enter drainage area, A	A = acres

1-2. Enter the maximum allowable percent of the Project area that may be effective impervious area (refer to permit), ranges from 5-30%, $\%_{allowable}$	$\%_{allowable} =$ %
1-3. Determine the maximum allowed effective impervious area, $EIA_{allowable} = (A_{project}) * (\%_{allowable})$	$EIA_{allowable} =$ acres
1-4. Enter Project impervious fraction, Imp (e.g. 60% = 0.60)	$Imp =$
1-5. Determine the Project Total Impervious area, $TIA = A_{project} * Imp$	$TIA =$ acres
1-6. Determine the total area from which runoff must be retained, $A_{retain} = TIA - EIA_{allowable}$	$A_{retain} =$ acres
1-7. Determine pervious runoff coefficient using Table E-1, C_p	$C_p =$
1-8. Calculate runoff coefficient, $C = 0.95 * imp + C_p (1 - imp)$	$C =$
1-9. Enter design rainfall depth of the storm, P_i (in)	$P_i =$ in
1-10. Calculate rainfall depth, $P = P_i / 12$	$P =$ ft
1-11. Calculate water quality design volume, $SQDV = 43560 * P * A_{retain} * C$	$SQDV =$ ft ³
Step 2: Determine active design volume for the wet pond without extended detention	
2-1. Calculate the active design volume (without extended detention), $V_a = 1.05 * SQDV$	$V_a =$ ft ³
Step 3: Determine Pond Location and Preliminary Geometry Based on Site Constraints	

<p>3-1. Based on site constraints, determine the pond geometry and the storage available by developing an elevation-storage relationship for the pond. For this simple example, assume a trapezoidal geometry for cell 1 (forebay) and cell 2.</p>	
<p>3-2. Enter the total surface area of the pond footprint based on site constraints, A_{tot}</p>	<p>$A_{tot} =$ ft²</p>
<p>3-3. Enter the length of the pond footprint based on site constraints, L_{tot}</p>	<p>$L_{tot} =$ ft</p>
<p>3-4. Calculate the width of the pond footprint, $W_{tot} = A_{tot} / L_{tot}$</p>	<p>$W_{tot} =$ ft</p>
<p>3-5. Enter interior side slope as length per unit height (min = 3), Z</p>	<p>$Z =$</p>
<p>3-6. Enter desired freeboard depth, d_{fb} (1 ft min)</p>	<p>$d_{fb} =$ ft</p>
<p>3-7. Calculate the length of the water quality volume surface area including the internal berm but excluding freeboard, $L_{av-tot} = L_{tot} - 2Zd_{fb}$</p>	<p>$L_{av-tot} =$ ft</p>
<p>3-8. Calculate the width of the water quality volume surface area including the internal berm but excluding freeboard, $W_{av-tot} = W_{tot} - 2Zd_{fb}$</p>	<p>$W_{av-tot} =$ ft</p>
<p>3-9. Calculate the total water quality volume surface area including the internal berm and excluding freeboard, $A_{av-tot} = L_{av-tot} \cdot W_{av-tot}$</p>	<p>$A_{av-tot} =$ ft²</p>
<p>3-10. Enter the width of the internal berm (6 ft min), W_{berm}</p>	<p>$W_{berm} =$ ft</p>
<p>3-11. Enter the length of the internal berm, $L_{berm} = W_{av-tot}$</p>	<p>$L_{berm} =$ ft</p>
<p>3-12. Calculate the area of the berm, $A_{berm} = W_{berm} \cdot L_{berm}$</p>	<p>$A_{berm} =$ ft²</p>
<p>3-13. Calculate the water quality volume surface area excluding the internal berm and freeboard, $A_{av} = A_{av-tot} - A_{berm}$</p>	<p>$A_{av} =$ ft²</p>

Step 4: Determine Dimensions of forebay	
4-1. Enter the percent of V_a in forebay (5-10% required), $\%V_1$	$\%V_1 = \quad \%$
4-2. Calculate the active volume of forebay (includes sediment storage volume), $V_1 = (V_a \cdot \%V_1) / 100$	$V_1 = \quad \text{ft}^3$
4-3. Enter desired average depth of forebay (5-9 ft including sediment storage of 1 ft), d_1	$d_1 = \quad \text{ft}$
4-4. Calculate the surface area for the active volume of forebay, $A_1 = V_1 / d_1$	$A_1 = \quad \text{ft}^2$
4-5. Enter the width of forebay, $W_1 = W_{av-tot} = L_{berm}$	$W_1 = \quad \text{ft}$
4-6. Calculate the length of forebay (<u>Note:</u> inlet and outlet should be configured to maximize the residence time), $L_1 = A_1 / W_1$	$L_1 = \quad \text{ft}$
Step 5: Determine Dimensions of Cell 2	
5-1. Calculate the active volume of Cell 2, $V_2 = V_a - V_1$	$V_2 = \quad \text{ft}^3$
5-2. Determine minimum wetpool surface area, $A_{min2} = V_2 \cdot 0.3$	$A_{min2} = \quad \text{ft}^2$
5-3. Determine actual wetpool surface area, $A_2 = A_{av} - A_1$	$A_2 = \quad \text{ft}^2$
5-4. <ul style="list-style-type: none"> • If A_2 is greater than A_{min2} then move on to step 5-5. • If A_2 is less than A_{min2}, then modify input parameters to increase A_2 until it is greater than A_{min2}. If site constraints limit this criterion, then another site for the pond should be chosen. 	
5-5. Enter width of Cell 2, $W_2 = W_1 = W_{av-tot} = L_{berm}$	$W_2 = \quad \text{ft}$
5-6. Calculate top length of Cell 2, $L_2 = A_2 / W_2$	$L_2 = \quad \text{ft}$

5-7. Verify that the length-to-width ratio of Cell 2 is at least 1.5:1 with $\geq 2:1$ preferred. If the length-to-width ratio is less than 1.5:1, modify input parameters until a ratio of at least 1.5:1 is achieved. If the input parameters cannot be modified as a result of site constraints, another site for the pond should be chosen, $LW_2 = L_2 / W_2$	$LW_2 =$
5-8. Enter percent of surface area that will be planted with emergent vegetation (25-75%), $\%A_{ev}$	$\%A_{ev} =$ %
5-9. Calculate emergent vegetation surface area, $A_{ev} = (A_2 \cdot \%A_{ev})/100$	$A_{ev} =$ ft ²
5-10. Enter average depth of emergent vegetation shallow zone (1.5 – 3 ft), d_{ev}	$d_{ev} =$ ft
5-11. Calculate volume of emergent vegetation shallow zone (1.5 – 3 ft), $V_{ev} = A_{ev} \cdot d_{ev}$	$V_{ev} =$ ft ³
5-12. Enter width of emergent vegetation shallow zone, $W_{ev} = W_2$	$W_{ev} =$ ft
5-13. Calculate length of emergent vegetation shallow zone, $L_{ev} = A_{ev} / W_{ev}$	$L_{ev} =$ ft
5-14. Calculate volume of deep zone, $V_{deep} = V_2 - V_{ev}$	$V_{deep} =$ ft ³
5-15. Calculate surface area of deep (>3 ft) zone, $A_{deep} = A_2 - A_{ev}$	$A_{deep} =$ ft ²
5-16. Calculate average depth of deep zone (4 - 8 ft), $d_{deep} = V_{deep} / A_{deep}$	$d_{deep} =$ ft
5-17. Enter width of deep zone, $W_{deep} = W_2$	$W_{deep} =$ ft
5-18. Calculate length of deep zone, $L_{deep} = A_{deep} / W_{deep}$	$L_{deep} =$ ft
Step 6: Ensure Design Requirements and Site Constraints are Achieved	

6-1. Check design requirements and site constraints. Modify design geometry until requirements are met. If the chosen site for the basin is inadequate to meet the design requirements, choose a new location for the BMP.

Step 7: Size Outlet Structure

7-1. The basin outlet pipe shall be sized, at a minimum, to pass flows greater than the stormwater quality design peak flow for off-line basins or flows greater than the peak runoff discharge rate for the 100-year, 24-hr design storm for on-line basins.

Step 8: Determine Emergency Spillway Requirements

8-1. For online basins, an emergency overflow spillway should be sized to pass flows greater than the design peak runoff discharge rate for the 100-yr, 24-hr storm to prevent overtopping of the walls or berms in the event that a blockage of the riser occurs. For offline basins, an emergency spillway or riser should be sized to pass the water quality design storm. For sites where the emergency spillway discharges to a steep slope, an emergency overflow riser, in addition to the spillway should be provided.

Design Example

Wet detention basin siting requires the following considerations prior to construction: (1) availability of base flow – wet detention basins require a regular source of water if water level is to be maintained, (2) surface space availability – large footprint area is required, and (3) compatibility with flood control – basins must not interfere with flood control functions of existing conveyance and detention structures.

The wet detention basin in this example does not have extended detention. An internal berm separates the forebay (Cell 1) and the main basin (Cell 2). The berm is at the elevation of the active volume design surface which is also the permanent wetpool elevation.

Step 1: Determine Water Quality Design Volume

For this design example, a 20-acre residential development with a 60% total impervious area is considered.

Step 1: Determine water quality design volume	
1-1. Enter drainage area, A	A = 20 acres
1-2. Enter the maximum allowable percent of the Project area that may be effective impervious area (refer to permit), ranges from 5-30%, $\%_{allowable}$	$\%_{allowable} = 5$
1-3. Determine the maximum allowed effective impervious area, $EIA_{allowable} = (A_{project}) * (\%_{allowable})$	$EIA_{allowable} = 1.0$ acres
1-4. Enter Project impervious fraction, Imp (e.g. 60% = 0.60)	$Imp = 0.6$
1-5. Determine the Project Total Impervious area, $TIA = A_{project} * Imp$	$TIA = 12$ acres
1-6. Determine the total area from which runoff must be retained, $A_{retain} = TIA - EIA_{allowable}$	$A_{retain} = 11$ acres
1-7. Determine pervious runoff coefficient using Table E-1 , C_p	$C_p = 0.05$
1-8. Calculate runoff coefficient, $C = 0.95 * imp + C_p (1 - imp)$	$C = 0.59$
1-9. Enter design rainfall depth of the storm, P_i (in)	$P_i = 0.75$ in
1-10. Calculate rainfall depth, $P = P_i / 12$	$P = 0.06$ ft

1-11. Calculate water quality design volume, $SQDV = 43560 \cdot P \cdot A_{retain} \cdot C$	$SQDV = 17,000 \text{ ft}^3$
---	------------------------------

Step 2: Determine Active Design Volume for a Wet Detention Basin without Extended Detention

If there is no extended detention provided, wet detention basins shall be sized to provide a minimum wet pool volume equal to the water quality design volume plus an additional 5% for sediment accumulation.

Step 2: Determine Active Design Volume for a Wet Detention Basin without Extended Detention	
2-1. Calculate the active design volume (without extended detention), $V_a = 1.05 \cdot SQDV$	$V_a = 17,800 \text{ ft}^3$

Step 3: Determine Pond Location and Preliminary Geometry Based on Site Constraints

A total footprint area and total length available for the basin is provided. This step calculates the total active volume surface area which is equivalent to the permanent wetpool surface area. This step also calculates the dimensions of the internal berm.

Step 3: Determine Pond Location and Preliminary Geometry Based on Site Constraints	
3-1. Based on site constraints, determine the pond geometry and the storage available by developing an elevation-storage relationship for the pond. For this simple example, assume a trapezoidal geometry for cell 1 (forebay) and cell 2.	
3-2. Enter the total surface area of the pond footprint based on site constraints, A_{tot}	$A_{tot} = 7,500 \text{ ft}^2$
3-3. Enter the length of the pond footprint based on site constraints, L_{tot}	$L_{tot} = 150 \text{ ft}$
3-4. Calculate the width of the pond footprint, $W_{tot} = A_{tot} / L_{tot}$	$W_{tot} = 50 \text{ ft}$
3-5. Enter interior side slope as length per unit height (min = 3), Z	$Z = 3$

Step 3: Determine Pond Location and Preliminary Geometry Based on Site Constraints	
3-6. Enter desired freeboard depth, d_{fb} (1 ft min)	$d_{fb} = 2 \text{ ft}$
3-7. Calculate the length of the water quality volume surface area including the internal berm but excluding freeboard, $L_{av-tot} = L_{tot} - 2Zd_{fb}$	$L_{av-tot} = 138 \text{ ft}$
3-8. Calculate the width of the water quality volume surface area including the internal berm but excluding freeboard, $W_{av-tot} = W_{tot} - 2Zd_{fb}$	$W_{av-tot} = 38 \text{ ft}$
3-9. Calculate the total water quality volume surface area including the internal berm and excluding freeboard, $A_{av-tot} = L_{av-tot} \cdot W_{av-tot}$	$A_{av-tot} = 4,940 \text{ ft}^2$
3-10. Enter the width of the internal berm (6 ft min), W_{berm}	$W_{berm} = 6 \text{ ft}$
3-11. Enter the length of the internal berm, $L_{berm} = W_{av-tot}$	$L_{berm} = 38 \text{ ft}$
3-12. Calculate the area of the berm, $A_{berm} = W_{berm} \cdot L_{berm}$	$A_{berm} = 230 \text{ ft}^2$
3-13. Calculate the water quality volume surface area excluding the internal berm and freeboard, $A_{av} = A_{av-tot} - A_{berm}$	$A_{av} = 4,710 \text{ ft}^2$

Step 4: Determine Dimensions of forebay

It should be assumed that the forebay should be 5-10% of the total active design volume, V_a .

Step 4: Determine Dimensions of Cell 1	
4-1. Enter the percent of V_a in forebay (5-10% required), $\%V_1$	$\%V_1 = 20 \%$
4-2. Calculate the active volume of forebay (includes sediment storage volume), $V_1 = (V_a \cdot \%V_1) / 100$	$V_1 = 3,560 \text{ ft}^3$
4-3. Enter desired average depth of forebay (5-9 ft including sediment storage of 1 ft), d_1	$d_1 = 8 \text{ ft}$

4-4. Calculate the surface area for the active volume of forebay, $A_1 = V_1 / d_1$	$A_1 =$ 440 ft ²
4-5. Enter the width of forebay, $W_1 = W_{av-tot} = L_{berm}$	$W_1 =$ 38 ft
4-6. Calculate the length of forebay (<u>Note:</u> inlet and outlet should be configured to maximize the residence time), $L_1 = A_1 / W_1$	$L_1 =$ 12 ft

Step 5: Determine Dimensions of Cell 2

Verify that the surface area and length-to-width ratio of Cell 2 meet the design criteria. Calculate volumes, depths and surface areas for the emergent vegetation shallow zone and the deep zone.

Step 5: Determine Dimensions of Cell 2	
5-1. Calculate the active volume of Cell 2, $V_2 = V_a - V_1$	$V_2 =$ 14,200 ft ³
5-2. Determine minimum wetpool surface area, $A_{min2} = V_2 \cdot 0.3$	$A_{min2} =$ 4,270 ft ²
5-3. Determine actual wetpool surface area, $A_2 = A_{av} - A_1$	$A_2 =$ 4,270 ft ²
5-4. If A_2 is greater than A_{min2} then move on to step 5-5. If A_2 is less than A_{min2} , then modify input parameters to increase A_2 until it is greater than A_{min2} . If site constraints limit this criterion, then another site for the pond should be chosen.	
5-5. Enter width of Cell 2, $W_2 = W_1 = W_{av-tot} = L_{berm}$	$W_2 =$ 38 ft
5-6. Calculate top length of Cell 2, $L_2 = A_2 / W_2$	$L_2 =$ 110 ft
5-7. Verify that the length-to-width ratio of Cell 2 is at least 1.5:1 with $\geq 2:1$ preferred. If the length-to-width ratio is less than 1.5:1, modify input parameters until a ratio of at least 1.5:1 is achieved. If the input parameters cannot be modified as a result of site constraints, another site for the pond should be chosen, $LW_2 = L_2 / W_2$	$LW_2 =$ 2.9
5-8. Enter percent of surface area that will be planted with emergent vegetation (25-75%), $\%A_{ev}$	$\%A_{ev} =$ 25 %

5-9. Calculate emergent vegetation surface area, $A_{ev} = (A_2 \cdot \%A_{ev})/100$	$A_{ev} = 1,070 \text{ ft}^2$
5-10. Enter average depth of emergent vegetation shallow zone (1.5 – 3 ft), d_{ev}	$d_{ev} = 2 \text{ ft}$
5-11. Calculate volume of emergent vegetation shallow zone (1.5 – 3 ft), $V_{ev} = A_{ev} \cdot d_{ev}$	$V_{ev} = 2,130 \text{ ft}^3$
5-12. Enter width of emergent vegetation shallow zone, $W_{ev} = W_2$	$W_{ev} = 38 \text{ ft}$
5-13. Calculate length of emergent vegetation shallow zone, $L_{ev} = A_{ev} / W_{ev}$	$L_{ev} = 56 \text{ ft}$
5-14. Calculate volume of deep zone, $V_{deep} = V_2 - V_{ev}$	$V_{deep} = 13,100 \text{ ft}^3$
5-15. Calculate surface area of deep (>3 ft) zone, $A_{deep} = A_2 - A_{ev}$	$A_{deep} = 3,200 \text{ ft}^2$
5-16. Calculate average depth of deep zone (4 - 8 ft), $d_{deep} = V_{deep} / A_{deep}$	$d_{deep} = 4.1 \text{ ft}$
5-17. Enter width of deep zone, $W_{deep} = W_2$	$W_{deep} = 28 \text{ ft}$
5-18. Calculate length of deep zone, $L_{deep} = A_{deep} / W_{deep}$	$L_{deep} = 114 \text{ ft}$

Step 6: Ensure Design Requirements and Site Conditions are Achieved

Check design requirements and site constraints. Modify design geometry until requirements are met. If the chosen site for the basin is inadequate to meet the design requirements, choose a new location for the BMP.

Step 7: Size Outlet Structure

The basin outlet pipe shall be sized, at a minimum, to pass flows greater than the stormwater quality design peak flow for off-line basins or flows greater than the peak runoff discharge rate for the 100-year, 24-hr design storm for on-line basins.

Step 8: Determine Emergency Spillway Requirements

For online basins, an emergency overflow spillway should be sized to pass flows greater than the design peak runoff discharge rate for the 100-yr, 24-hr storm to prevent overtopping of the walls or berms in the event that a blockage of the riser occurs. For offline basins, an

emergency spillway or riser should be sized to pass the water quality design storm. For sites where the emergency spillway discharges to a steep slope, an emergency overflow riser, in addition to the spillway should be provided.

E.10 TCM-3 Constructed Wetland

Sizing Methodology

In most cases, the constructed treatment wetland permanent pool shall be sized to be greater than or equal to the stormwater quality design volume. If extended detention is provided above the permanent pool and the wetland is designed for water quality treatment only, then the permanent pool volume shall be a minimum of 80 percent of the stormwater quality design volume and the surcharge volume (above the permanent pool) shall make up the remaining 20 percent and provide at least 12 hours of detention. If extended detention is provided and the basin is designed for water quality treatment and peak flow attenuation, then the permanent pool volume shall be equal to the water quality treatment volume and the surcharge volume shall be sized to attenuate peak flows to meet the peak runoff discharge requirements. The extended detention portion of the wetland above the permanent pool, if provided, functions like a dry extended detention (ED) basin (see [VEG-5: Dry Extended Detention Basin](#)).

Step 1: Calculate the design volume

Constructed wetlands shall be sized to be greater than or equal to the SQDV volume (see [Section 2](#) and Appendix E).

Step 2: Determine the Wetland Location, Wetland Type and Preliminary Geometry Based on Site Constraints

Based on site constraints, determine the wetland geometry and the storage available by developing an elevation-storage relationship for the wetland. The equations provided below assume a trapezoidal geometry for cell 1 (Forebay) and cell 2, and assumes that the wetland does not have extended detention.

- 1) Calculate the width of the wetland footprint, W_{tot} , as follows:

$$W_{tot} = \frac{A_{tot}}{L_{tot}} \quad \text{(Equation E-78)}$$

Where:

A_{tot} = total surface area of the wetland footprint (ft²)

L_{tot} = total length of the wetland footprint (ft)

- 12) Calculate the length of the water quality volume surface area including the internal berm but excluding the freeboard, L_{wq-tot} :

$$L_{wq-tot} = L_{tot} - 2Zd_{fb} \quad \text{(Equation E-79)}$$

Where:

Z = interior side slope as length per unit height

d_{fb} = freeboard depth

- 13) Calculate the width of the water quality volume surface area including the internal berm but excluding freeboard, W_{wq-tot} :

$$W_{wq-tot} = W_{tot} - 2Zd_{fb} \quad (\text{Equation E-80})$$

- 14) Calculate the total water quality volume surface area including the internal berm and excluding freeboard, A_{wq-tot} :

$$A_{wq-tot} = L_{wq-tot} \times W_{wq-tot} \quad (\text{Equation E-81})$$

- 15) Calculate the area of the berm, A_{berm} :

$$A_{berm} = W_{berm} \times L_{berm} \quad (\text{Equation E-82})$$

Where:

W_{berm} = width of the internal berm

L_{berm} = length of the internal berm

- 16) Calculate the water quality surface area excluding the internal berm and freeboard, A_{wq} :

$$A_{wq} = A_{wq-tot} - A_{berm} \quad (\text{Equation E-83})$$

Step 3: Determine Dimensions of Forebay

30-50% of the SQDV is required to be within the active volume of forebay.

- 1) Calculate the active volume of forebay, V_1 :

$$V_1 = \frac{SQDV \times \%V_1}{100} \quad (\text{Equation E-84})$$

Where:

$\%V_1$ = percent of SQDV in forebay (%)

- 2) Calculate the surface area for the active volume of forebay, A_1 :

$$A_1 = \frac{V_1}{d_1} \quad (\text{Equation E-85})$$

Where:

d_1 = average depth for the active volume of forebay (2 -4 ft) (ft)

- 3) Calculate the length of forebay, L_1 . Note, inlet and outlet should be configured to maximize the residence time.

$$L_1 = \frac{A_1}{W_1} \quad \text{(Equation E-86)}$$

Where:

$$W_1 = \text{width of forebay (ft), } W_1 = W_{av-tot} = L_{berm}$$

Step 4: Determine Dimensions of Cell 2

Cell 2 will consist of the remainder of the basin's active volume.

- 1) Calculate the active volume of Cell 2, V_2 :

$$V_2 = SQDV - V_1 \quad \text{(Equation E-87)}$$

- 2) Calculate the surface area of Cell 2, A_2 :

$$A_2 = A_{wq} - A_1 \quad \text{(Equation E-88)}$$

- 3) Calculate the top length of Cell 2, L_2 :

$$L_2 = \frac{A_2}{W_2} \quad \text{(Equation E-89)}$$

Where:

$$W_2 = \text{width of Cell 2 (ft), } W_2 = W_1 = W_{wq-tot} = L_{berm}$$

- 4) Verify that the length-to-width ratio of Cell 2, LW_2 , is at least 3:1 with $\geq 4:1$ preferred. If the length-to-width ratio is less than 3:1, modify input parameters until a ratio of at least 3:1 is achieved. If the input parameters cannot be modified as a result of site constraints, another site for the pond should be chosen.

$$LW_2 = \frac{L_2}{W_2} \quad \text{(Equation E-90)}$$

- 5) Calculate the very shallow zone surface area, A_{vs} :

$$A_{vs} = \frac{A_2 \cdot \%A_{vs}}{100} \quad \text{(Equation E-91)}$$

Where:

$$\%A_{vs} = \text{percent of surface area of very shallow zone}$$

- 6) Calculate the volume of the shallow zone, V_{vs} :

$$V_{vs} = A_{vs} \bullet d_{vs} \quad \text{(Equation E-92)}$$

Where:

d_{vs} = average depth of the very shallow zone (0.1 – 1 ft)

7) Calculate the length of the very shallow zone, L_{vs} :

$$L_{vs} = \frac{A_{vs}}{W_{vs}} \quad \text{(Equation E-93)}$$

Where:

W_{vs} = width of the very shallow zone (ft), $W_{vs} = W_2$

8) Calculate the surface area of the shallow zone, A_s :

$$A_s = \frac{A_2 \bullet \% A_s}{100} \quad \text{(Equation E-94)}$$

Where:

$\%A_s$ = percent of surface area of shallow zone

9) Calculate the volume of the shallow zone, V_s :

$$V_s = A_s \bullet d_s \quad \text{(Equation E-95)}$$

Where:

d_s = average depth of shallow zone (1 - 3 ft)

10) Calculate length of the shallow zone, L_s :

$$L_s = \frac{A_s}{W_s} \quad \text{(Equation E-96)}$$

Where:

W_s = width of the shallow zone (ft), $W_s = W_2$

11) Calculate the surface area of the deep zone, A_{deep} :

$$A_{deep} = A_2 - A_{vs} - A_s \quad \text{(Equation E-97)}$$

12) Calculate the volume of the deep zone, V_{deep} :

$$V_{deep} = V_2 - V_{vs} - V_s \quad \text{(Equation E-98)}$$

13) Calculate the average depth of the deep zone (3-5 ft), d_{deep} :

$$d_{deep} = \frac{V_{deep}}{A_{deep}} \quad \text{(Equation E-99)}$$

14) Calculate length of the deep zone, L_{deep} :

$$L_{deep} = \frac{A_{deep}}{W_{deep}} \quad \text{(Equation E-100)}$$

Where:

W_{deep} = width of the deep zone (ft), $W_{deep} = W_2$

Step 5: Ensure design requirements and site constraints are achieved

Check design requirements and site constraints. Modify design geometry until requirements are met. If the chosen site for the basin is inadequate to meet the design requirements, choose a new location or alternative treatment BMP.

Step 6: Size Outlet Structure

For wetlands with detention, the outlet structures shall be designed to provide 12 hours emptying time for the water quality volume or the required detention necessary for achieving the peak runoff discharge requirements if the extended detention is designed for flow attenuation.

The wetland outlet pipe shall be sized, at a minimum, to pass flows greater than the stormwater quality design peak flow for on-line basins or flows greater than the peak runoff discharge rate for the 100-year, 24-hr design storm for on-line basins.

Step 7: Determine Emergency Spillway Requirements

For online basins, an emergency overflow spillway should be sized to pass flows greater than the design peak runoff discharge rate for the 100-yr, 24-hr storm in order to prevent overtopping of the walls or berms in the event that a blockage of the riser occurs. For offline basins, an emergency spillway or riser should be sized to pass the 100-yr, 24-hr post-development peak storm water runoff discharge rate directly to the downstream conveyance system or another acceptable discharge point. For sites where the emergency spillway discharges to a steep slope, an emergency overflow riser, in addition to the spillway should be provided.

Sizing Worksheet

Step 1: Determine water quality design volume		
1-1. Enter drainage area, A	A =	acres
1-2. Enter the maximum allowable percent of the Project area that may be effective impervious area (refer to permit), ranges from 5-30%, $\%_{allowable}$	$\%_{allowable} =$	%
1-3. Determine the maximum allowed effective impervious area, $EIA_{allowable} = (A_{project}) * (\%_{allowable})$	$EIA_{allowable} =$	acres
1-4. Enter Project impervious fraction, Imp (e.g. 60% = 0.60)	Imp =	
1-5. Determine the Project Total Impervious area, $TIA = A_{project} * Imp$	TIA =	acres
1-6. Determine the total area from which runoff must be retained, $A_{retain} = TIA - EIA_{allowable}$	$A_{retain} =$	acres
1-7. Determine pervious runoff coefficient using Table E-1, C_p	$C_p =$	
1-8. Calculate runoff coefficient, $C = 0.95 * imp + C_p (1 - imp)$	C =	
1-9. Enter design rainfall depth of the storm, P_i (in)	$P_i =$	in
1-10. Calculate rainfall depth, $P = P_i / 12$	P =	ft
1-11. Calculate water quality design volume, $SQDV = 43560 * P * A_{retain} * C$	SQDV =	ft ³
Step 2: Determine Wetland Location, Wetland Type and Preliminary Geometry Based on Site Constraints		
2-1. Based on site constraints, determine the wetland geometry and the storage available by developing an elevation-storage relationship for the wetland. For this simple example, assume a trapezoidal geometry for cell 1 (forebay) and cell 2. The wetland does not have extended detention.		

2-2. Enter the total surface area of the wetland footprint based on site constraints, A_{tot}	$A_{tot} =$ ft ²
2-3. Enter the length of the wetland footprint based on site constraints, L_{tot}	$L_{tot} =$ ft
2-4. Calculate the width of the wetland footprint, $W_{tot} = A_{tot} / L_{tot}$	$W_{tot} =$ ft
2-5. Enter interior side slope as length per unit height (min = 3), Z	$Z =$
2-6. Enter desired freeboard depth, d_{fb}	$d_{fb} =$ ft
2-7. Calculate the length of the water quality volume surface area including the internal berm but excluding freeboard, $L_{wq-tot} = L_{tot} - 2Zd_{fb}$	$L_{wq-tot} =$ ft
2-8. Calculate the width of the water quality volume surface area including the internal berm but excluding freeboard, $W_{wq-tot} = W_{tot} - 2Zd_{fb}$	$W_{wq-tot} =$ ft
2-9. Calculate the total water quality volume surface area including the internal berm and excluding freeboard, $A_{wq-tot} = L_{wq-tot} \cdot W_{wq-tot}$	$A_{wq-tot} =$ ft ²
2-10. Enter the width of the internal berm (6 ft min), W_{berm}	$W_{berm} =$ ft
2-11. Enter the length of the internal berm, $L_{berm} = W_{wq-tot}$	$L_{berm} =$ ft
2-12. Calculate the area of the berm, $A_{berm} = W_{berm} \cdot L_{berm}$	$A_{berm} =$ ft ²
2-13. Calculate the water quality volume surface area excluding the internal berm and freeboard, $A_{wq} = A_{wq-tot} - A_{berm}$	$A_{wq} =$ ft ²
Step 3: Determine Dimensions of forebay	
3-1. Enter the percent of SQDV in forebay (30-50% required), $\%V_1$	$\%V_1 =$ %
3-2. Calculate the active volume of forebay (includes water quality volume + sediment storage volume),	$V_1 =$ ft ³

$V_1 = (\text{SQDV} \cdot \%V_1) / 100$	
3-3. Enter desired average depth of forebay1 (2-4 ft including sediment storage of 1 ft), d_1	$d_1 =$ ft
3-4. Calculate the surface area for the water quality volume of forebay, $A_1 = V_1 / d_1$	$A_1 =$ ft ²
3-5. Enter the width of forebay, $W_1 = W_{\text{av-tot}} = L_{\text{berm}}$	$W_1 =$ ft
3-6. Calculate the length of forebay (Note: inlet and outlet should be configured to maximize the residence time), $L_1 = A_1 / W_1$	$L_1 =$ ft
Step 4: Determine Dimensions of Cell 2	
4-1. Calculate the active volume of Cell 2, $V_2 = \text{SQDV} - V_1$	$V_2 =$ ft ³
4-2. Calculate surface area of Cell 2, $A_2 = A_{\text{wq}} - A_1$	$A_2 =$ ft ²
4-3. Enter width of Cell 2, $W_2 = W_1 = W_{\text{wq-tot}} = L_{\text{berm}}$	$W_2 =$ ft
4-4. Calculate top length of Cell 2, $L_2 = A_2 / W_2$	$L_2 =$ ft
4-5. Verify that the length-to-width ratio of Cell 2 is at least 3:1 with $\geq 4:1$ preferred. If the length-to-width ratio is less than 3:1, modify input parameters until a ratio of at least 3:1 is achieved. If the input parameters cannot be modified as a result of site constraints, another site for the pond should be chosen, $LW_2 = L_2 / W_2$	$LW_2 =$
4-6. Enter percent of surface area of very shallow zone, $\%A_{\text{vs}}$	$\%A_{\text{vs}} =$ %
4-7. Calculate very shallow zone surface area, $A_{\text{vs}} = (A_2 \cdot \%A_{\text{vs}}) / 100$	$A_{\text{vs}} =$ ft ²
4-8. Enter average depth of very shallow zone (0.1 - 1 ft), d_{vs}	$d_{\text{vs}} =$ ft
4-9. Calculate volume of very shallow zone, $V_{\text{vs}} = A_{\text{vs}} \cdot d_{\text{vs}}$	$V_{\text{vs}} =$ ft ³
4-10. Enter width of very shallow zone, $W_{\text{vs}} = W_2$	$W_{\text{vs}} =$ ft

4-11. Calculate length of very shallow zone, $L_{vs} = A_{vs} / W_{vs}$	$L_{vs} =$ ft
4-12. Enter percent of surface area of shallow zone, $\%A_s$	$\%A_s =$ %
4-13. Calculate surface area of shallow zone, $A_s = (A_2 \cdot \%A_s)/100$	$A_s =$ ft ²
4-14. Enter average depth of shallow zone (1 - 3 ft), d_s	$d_s =$ ft
4-15. Calculate volume of shallow zone, $V_s = A_s \cdot d_s$	$V_s =$ ft ³
4-16. Enter width of shallow zone, $W_s = W_2$	$W_s =$ ft
4-17. Calculate length of shallow zone, $L_s = A_s / W_s$	$L_s =$ ft
4-18. Calculate surface area of deep zone, $A_{deep} = A_2 - A_{vs} - A_s$	$A_{deep} =$ ft ²
4-19. Calculate volume of deep zone, $V_{deep} = V_2 - V_{vs} - V_s$	$V_{deep} =$ ft ³
4-20. Calculate average depth of deep zone (3 - 5 ft), $d_{deep} = V_{deep} / A_{deep}$	$d_{deep} =$ ft
4-21. Enter width of deep zone, $W_{deep} = W_2$	$W_{deep} =$ ft
4-22. Calculate length of deep zone, $L_{deep} = A_{deep} / W_{deep}$	$L_{deep} =$ ft
Step 5: Ensure Design Requirements and Site Constraints are Achieved	
5-1. Check design requirements and site constraints. Modify design geometry until requirements are met. If the chosen site for the wetland is inadequate to meet the design requirements, choose a new location for the wetland or select an alternative treatment BMP.	
Step 6: Size Outlet Structure	

6-1. The wetland outlet pipe shall be sized, at a minimum, to pass flows greater than the stormwater quality design peak flow for off-line basins or flow from the capital storm for on-line basins.

Step 7: Determine Emergency Spillway Requirements

7-1. For online basins, an emergency overflow spillway should be sized to pass flows greater than the design peak runoff discharge rate for the 100-yr, 24-hr storm in order to prevent overtopping of the walls or berms in the event that a blockage of the riser occurs. For offline basins, an emergency spillway or riser should be sized to pass the 100-yr, 24-hr post-development peak storm water runoff discharge rate directly to the downstream conveyance system or another acceptable discharge point.

Design Example

Wetland siting requires the following considerations prior to construction: (1) availability of base flow – stormwater wetlands require a regular source of water to support wetland biota, (2) slope stability – stormwater wetlands are not permitted near steep slope hazard areas, (3) surface space availability – large footprint area is required, and (4) compatibility with flood control – basins must not interfere with flood control functions of existing conveyance and detention structures.

The wetland in this example does not have extended detention. An internal berm separates the forebay (Cell 1) and the main basin (Cell 2). The berm is at the elevation of the active volume (SQDV plus sediment storage volume) design surface which is also the permanent wetpool elevation.

Step 1: Determine Water Quality Design Volume

For this design example, a 20-acre residential development with a 60% total impervious area is considered.

Step 1: Determine water quality design volume	
1-1. Enter drainage area, A	A = 20 acres
1-2. Enter the maximum allowable percent of the Project area that may be effective impervious area (refer to permit), ranges from 5-30%, % <i>allowable</i>	% <i>allowable</i> = 5
1-3. Determine the maximum allowed effective impervious area, $EIA_{allowable} = (A_{project}) * (\%_{allowable})$	$EIA_{allowable} = 1.0$ acres
1-4. Enter Project impervious fraction, <i>Imp</i> (e.g. 60% = 0.60)	Imp = 0.6
1-5. Determine the Project Total Impervious area, $TIA = A_{project} * Imp$	TIA = 12 acres
1-6. Determine the total area from which runoff must be retained, $A_{retain} = TIA - EIA_{allowable}$	$A_{retain} = 11$ acres
1-7. Determine pervious runoff coefficient using Table E-1 , <i>C_p</i>	$C_p = 0.05$
1-8. Calculate runoff coefficient, $C = 0.95 * imp + C_p (1 - imp)$	C = 0.59
1-9. Enter design rainfall depth of the storm, <i>P_i</i> (in)	$P_i = 0.75$ in

1-10. Calculate rainfall depth, $P = P_i/12$	P = 0.06 ft
1-11. Calculate water quality design volume, $SQDV = 43560 \cdot P \cdot A_{retain} \cdot C$	SQDV = 17,000 ft ³

Step 2: Determine Pond Location and Preliminary Geometry Based on Site Constraints

A total footprint area and total length available for the wetland is provided. This step calculates the total active volume surface area which is equivalent to the permanent wetpool surface area. This step also calculates the dimensions of the internal berm.

Step 2: Determine Wetland Location, Wetland Type and Preliminary Geometry Based on Site Constraints	
2-1. Based on site constraints, determine the wetland geometry and the storage available by developing an elevation-storage relationship for the wetland. For this simple example, assume a trapezoidal geometry for cell 1 (forebay) and cell 2. The wetland does not have extended detention.	
2-2. Enter the total surface area of the wetland footprint based on site constraints, A_{tot}	$A_{tot} = 7,500$ ft ²
2-3. Enter the length of the wetland footprint based on site constraints, L_{tot}	$L_{tot} = 200$ ft
2-4. Calculate the width of the wetland footprint, $W_{tot} = A_{tot} / L_{tot}$	$W_{tot} = 38$ ft
2-5. Enter interior side slope as length per unit height (min = 3), Z	$Z = 3$
2-6. Enter desired freeboard depth, d_{fb}	$d_{fb} = 2$ ft
2-7. Calculate the length of the water quality volume surface area including the internal berm but excluding freeboard, $L_{wq-tot} = L_{tot} - 2Zd_{fb}$	$L_{wq-tot} = 188$ ft
2-8. Calculate the width of the water quality volume surface area including the internal berm but excluding freeboard, $W_{wq-tot} = W_{tot} - 2Zd_{fb}$	$W_{wq-tot} = 26$ ft

Step 2: Determine Wetland Location, Wetland Type and Preliminary Geometry Based on Site Constraints	
2-9. Calculate the total water quality volume surface area including the internal berm and excluding freeboard, $A_{wq-tot} = L_{wq-tot} \cdot W_{wq-tot}$	$A_{wq-tot} = 4,900 \text{ ft}^2$
2-10. Enter the width of the internal berm (6 ft min), W_{berm}	$W_{berm} = 6 \text{ ft}$
2-11. Enter the length of the internal berm, $L_{berm} = W_{wq-tot}$	$L_{berm} = 26 \text{ ft}$
2-12. Calculate the area of the berm, $A_{berm} = W_{berm} \cdot L_{berm}$	$A_{berm} = 160 \text{ ft}^2$
2-13. Calculate the active volume surface area excluding the internal berm and freeboard, $A_{wq} = A_{wq-tot} - A_{berm}$	$A_{wq} = 4,740 \text{ ft}^2$

Step 3: Determine Dimensions of Forebay

It should be assumed that the forebay should be 30-50% of the SQDV.

Step 3: Determine Dimensions of forebay	
3-1. Enter the percent of SQDV in forebay (30-50% required), $\%V_1$	$\%V_1 = 30 \%$
3-2. Calculate the active volume of forebay (including sediment storage), $V_1 = (\text{SQDV} \cdot \%V_1)/100$	$V_1 = 5,100 \text{ ft}^3$
3-3. Enter desired average depth of forebay (2-4 ft including sediment storage of 1 ft), d_1	$d_1 = 4 \text{ ft}$
3-4. Calculate the surface area for the water quality volume of forebay, $A_1 = V_1 / d_1$	$A_1 = 1,275 \text{ ft}^2$
3-5. Enter the width of forebay, $W_1 = W_{av-tot} = L_{berm}$	$W_1 = 38 \text{ ft}$
3-6. Calculate the length of forebay (Note: inlet and outlet should be configured to maximize the residence time), $L_1 = A_1 / W_1$	$L_1 = 34 \text{ ft}$

Step 4: Determine Dimensions of Cell 2

Verify that the surface area and length-to-width ratio of Cell 2 meet the design criteria. Calculate volumes, depths and surface areas for the very shallow, shallow and deep zones.

Step 4: Determine Dimensions of Cell 2	
4-1. Calculate the active volume of Cell 2, $V_2 = \text{SQDV} - V_1$	$V_2 = 11,900 \text{ ft}^3$
4-2. Calculate surface area of Cell 2, $A_2 = A_{\text{wq}} - A_1$	$A_2 = 3,460 \text{ ft}^2$
4-3. Enter width of Cell 2, $W_2 = W_1 = W_{\text{wq-tot}} = L_{\text{berm}}$	$W_2 = 26 \text{ ft}$
4-4. Calculate top length of Cell 2, $L_2 = A_2 / W_2$	$L_2 = 130 \text{ ft}$
4-5. Verify that the length-to-width ratio of Cell 2 is at least 3:1 with $\geq 4:1$ preferred. If the length-to-width ratio is less than 3:1, modify input parameters until a ratio of at least 3:1 is achieved. If the input parameters cannot be modified as a result of site constraints, another site for the pond should be chosen, $LW_2 = L_2 / W_2$	$LW_2 = 5$
4-6. Enter percent of surface area of very shallow zone, $\%A_{\text{vs}}$	$\%A_{\text{vs}} = 15 \text{ ft}^2$
4-7. Calculate very shallow zone surface area, $A_{\text{vs}} = (A_2 \cdot \%A_{\text{vs}}) / 100$	$A_{\text{vs}} = 520 \text{ ft}^2$
4-8. Enter average depth of very shallow zone (0.1 - 1 ft), d_{vs}	$d_{\text{vs}} = 1 \text{ ft}$
4-9. Calculate volume of very shallow zone, $V_{\text{vs}} = A_{\text{vs}} \cdot d_{\text{vs}}$	$V_{\text{vs}} = 520 \text{ ft}^3$
4-10. Enter width of very shallow zone, $W_{\text{vs}} = W_2$	$W_{\text{vs}} = 26 \text{ ft}$
4-11. Calculate length of very shallow zone, $L_{\text{vs}} = A_{\text{vs}} / W_{\text{vs}}$	$L_{\text{vs}} = 20 \text{ ft}$
4-12. Enter percent of surface area of shallow zone, $\%A_{\text{s}}$	$\%A_{\text{s}} = 55$
4-13. Calculate surface area of shallow zone, $A_{\text{s}} = (A_2 \cdot \%A_{\text{s}}) / 100$	$A_{\text{s}} = 1,900 \text{ ft}^2$
4-14. Enter average depth of shallow zone (1 - 3 ft), d_{s}	$d_{\text{s}} = 3 \text{ ft}$
4-15. Calculate volume of shallow zone, $V_{\text{s}} = A_{\text{s}} \cdot d_{\text{s}}$	$V_{\text{s}} = 5,700 \text{ ft}^3$
4-16. Enter width of shallow zone, $W_{\text{s}} = W_2$	$W_{\text{s}} = 26 \text{ ft}$
4-17. Calculate length of shallow zone, $L_{\text{s}} = A_{\text{s}} / W_{\text{s}}$	$L_{\text{s}} = 220 \text{ ft}$

4-18. Calculate surface area of deep zone, $A_{\text{deep}} = A_2 - A_{\text{vs}} - A_s$	$A_{\text{deep}} =$ 1,040 ft ²
4-19. Calculate volume of deep zone, $V_{\text{deep}} = V_2 - V_{\text{vs}} - V_s$	$V_{\text{deep}} =$ 5,680 ft ³
4-20. Calculate average depth of deep zone (3 - 5 ft), $d_{\text{deep}} = V_{\text{deep}} / A_{\text{deep}}$	$d_{\text{deep}} =$ 5 ft
4-21. Enter width of deep zone, $W_{\text{deep}} = W_2$	$W_{\text{deep}} =$ 26 ft
4-22. Calculate length of deep zone, $L_{\text{deep}} = A_{\text{deep}} / W_{\text{deep}}$	$L_{\text{deep}} =$ 40 ft

Step 5: Ensure Design Requirements and Site Conditions are Achieved

Check design requirements and site constraints. Modify design geometry until requirements are met. If the chosen site for the wetland is inadequate to meet the design requirements, choose a new location for the wetland or select an alternative treatment BMP.

Step 6: Size Outlet Structure

6-1. The wetland outlet pipe shall be sized, at a minimum, to pass flows greater than the stormwater quality design peak flow for off-line basins or flow from the capital storm for on-line basins.

Step 7: Determine Emergency Spillway Requirements

For online basins, an emergency overflow spillway should be sized to pass flows greater than the design peak runoff discharge rate for the 100-yr, 24-hr storm in order to prevent overtopping of the walls or berms in the event that a blockage of the riser occurs. For offline basins, an emergency spillway or riser should be sized to pass the 100-yr, 24-hr post-development peak storm water runoff discharge rate directly to the downstream conveyance system or another acceptable discharge point.

E.11 TCM-4 Sand Filters

Sizing Methodology

A sand filter is designed with two parts: (1) a temporary storage reservoir to store runoff, and (2) a sand filter bed through which the stored runoff must percolate. Usually the storage reservoir is simply placed directly above the filter, and the floor of the reservoir pond is the top of the sand bed. For this case, the storage volume also determines the hydraulic head over the filter surface, which increases the rate of flow through the sand.

Two methods are available for sizing sand filters: a simple method and a routing modeling method. The simple method uses standard values to define filter hydraulic characteristics for determining the sand surface area. This method is useful for planning purposes, for a first approximation to begin iterations in the detailed method, or when use of the detailed computer model is not desired or not available. The simple method very often results in a larger filter than the routing method.

Background

Sand filter design is based on Darcy's law:

$$Q = KiA \quad \text{(Equation E-101)}$$

Where:

- Q = water quality design flow (cfs)
- K = hydraulic conductivity (fps)
- A = surface area perpendicular to the direction of flow (ft²)
- i = hydraulic gradient (ft/ft) for a constant head and constant media depth, computed as follows:

$$i = \frac{h+l}{l} \quad \text{(Equation E-102)}$$

Where:

- h = average depth of water above the filter (ft), defined for this design as $d/2$
- d = maximum storage depth above the filter (ft)
- l = thickness of sand media (ft)

Darcy's law underlies both the simple and the routing methods of design. The filtration rate V , or more correctly, $1/V$, is the direct input in the sand filter design. The relationship between the filtration rate V and hydraulic conductivity K is revealed by equating Darcy's law and the equation of continuity, $Q = VA$. Specifically:

$$Q = KiA \quad \text{and} \quad Q = VA$$

$$\text{So,} \quad VA = KiA$$

$$\text{Or:} \quad V = Ki \quad \text{(Equation E-103)}$$

Where,

$$V = \text{filtration rate (ft/s)}$$

Note that $V \neq K$. That is, the filtration rate is not the same as the hydraulic conductivity, but they do have the same units (distance per time). K can be equated to V by dividing V by the hydraulic gradient i , which is defined above.

The hydraulic conductivity K does not change with head nor is it dependent on the thickness of the media, only on the characteristics of the media and the fluid. A design hydraulic conductivity of 1 inch per hour (2 feet per day) used in this simple sizing method is based on bench-scale tests of conditioned rather than clean sand (KCSWDM, 2005) and represents the average sand bed condition as silt is captured and held in the sand bed.

Unlike the hydraulic conductivity, the filtration rate V changes with head and media thickness, although the media thickness is constant in the sand filter design.

Simple Sizing Method

The simple sizing method does not route flows through the filter. It determines the size of the filter based on the simple assumption that inflow is immediately discharged through the filter as if there were no storage volume. An adjustment factor (0.7) is applied to compensate for the greater filter size resulting from this method. Even with the adjustment factor, the simple method generally produces a larger filter size than the routing method.

Step 1: Determine the water quality design volume

Sand filters should be sized to capture and treat the stormwater quality design volume (see [Section E.1](#)).

Step 2: Determine maximum storage depth of water

Determine the maximum water storage depth (d) above the sand filter. This depth is defined as the depth at which water begins to overflow the reservoir pond, and it

depends on the site topography and hydraulic constraints. The depth is chosen by the designer, but shall be 6 feet or less.

Step 3: Calculate the sand filter area

Determine the sand filter area using the following equation:

$$A_{sf} = \frac{V_{wq}RL}{Kt(h+L)} \quad \text{(Equation E-104)}$$

Where,

A_{sf}	=	surface area of the sand filter bed (ft ²)
V_{wq}	=	water quality design volume (ft ³)
R	=	routing adjustment factor (use $R = 0.7$)
L	=	sand bed depth (ft)
K	=	design hydraulic conductivity (use 2 ft/day)
t	=	drawdown time (use 1 day)
h	=	average depth of water above the filter (ft), (use $d/2$ with d from Step 1)

Routing Method

A continuous runoff model, such as US EPA's Storm Water Management Model (SWMM) Model, can be used to optimally size a sand filter. A continuous simulation model consists of three components: a representative long term period of rainfall data (≈ 20 years or greater) as the primary model input; a model component representing the tributary area to the sand filter that takes into account the amount of impervious area, soil types of the pervious area, vegetation, evapotranspiration, etc.; and a component that simulates the sand filter. Using this method, the filter should be sized to capture and treat the WQ design volume from the post-development tributary area.

The continuous simulation model routes predicted tributary runoff to the sand filter, where treatment is simulated as a function of the infiltrative (flow) capacity of the sand filter and the available storage volume above the sand filter. In a continuous runoff model such as SWMM, the physical parameters of the sand filter are represented with stage-storage-discharge relationships. Due to the computational power of ordinary desktop computers, long-term continuous simulations generally take only minutes to run. This allows the modeler to run several simulations for a range of sand filter sizes, varying either the surface area of the filter (and resulting flow capacity) or the storage capacity above the sand filter, or both. Sufficient

continuous model simulations should be completed so that results encompass the WQ design volume capture goal.

Model results should be plotted for both varying storage depths above the filter and for varying filter surface area (and resulting flow capacity) while keeping all other parameters constant. The resulting relationship of percent capture as a function of sand filter flow and storage capacity can be used to optimally size a sand filter based on site conditions and restraints.

In addition to continuous simulation modeling, routing spreadsheets and/or other forms of routing modeling that incorporate rainfall-runoff relationships and infiltrative (flow) capacities of sand filters may be used to size facilities. Alternative sizing methodologies should be prepared with good engineering practices.

Sizing Worksheet

Step 1: Determine water quality design volume	
1-1. Enter Project area (acres), $A_{project}$	$A_{project} =$ acres
1-2. Enter the maximum allowable percent of the Project area that may be effective impervious area (refer to permit), ranges from 5-30%, $\%_{allowable}$	$\%_{allowable} =$ %
1-3. Determine the maximum allowed effective impervious area (ac), $EIA_{allowable} = (A_{project}) * (\%_{allowable})$	$EIA_{allowable} =$ acres
1-4. Enter Project impervious fraction, Imp (e.g. 60% = 0.60)	$Imp =$
1-5. Determine the Project Total Impervious area (acres), $TIA = A_{project} * Imp$	$TIA =$ acres
1-6. Determine the total area from which runoff must be retained (acres), $A_{retain} = TIA - EIA_{allowable}$	$A_{retain} =$ acres
1-7. Determine pervious runoff coefficient using <u>Table E-1</u> , C_p	$C_p =$
1-8. Calculate runoff coefficient, $C = 0.95 * imp + C_p (1 - imp)$	$C =$
1-9. Enter design rainfall depth of the storm (in), P_i (see Table D-3)	$P_i =$ in
1-10. Calculate rainfall depth (ft), $P = P_i / 12$	$P =$ ft
1-11. Calculate water quality design volume (ft ³), $SQDV = 43560 * C * P * A_{retain}$	$SQDV =$ ac-ft
Step 2: Determine maximum storage depth of water	
2-1. Determine the maximum storage depth (max 6 ft) of water above the sand filter, d (ft)	$d =$ ft

Step 3: Calculate sand filter area	
3-1. Enter water quality design volume, $SQDV$	$SQDV = \quad \text{ft}^3$
3-2. Enter routing adjustment factor (use $R = 0.7$), R	$R =$
3-3. Enter thickness of sand filter (min. 2 ft, 3 ft preferred), L	$L = \quad \text{ft}$
3-4. Enter design hydraulic conductivity of media (use 2 ft/day), K_{des}	$K = \quad \text{ft/day}$
3-5. Enter drawdown time, t	$t = \quad \text{day}$
3-6. Calculate average depth of water above the filter, $h = d/2$	$h = \quad \text{ft}$
3-7. Calculate sand filter area, $A_{sf} = (SQDV * RL) / (Kt (h + L))$	$A_{sf} = \quad \text{ft}^2$
Step 4: Determine filter dimensions	
4-1. Sand filter area, A_{sf}	$A_{sf} = \quad \text{ft}^2$
4-2. Enter geometric configuration, LR:W ratio (2:1 or greater), L_R	$L_R =$
4-3. Select the width of the sand filter, W	$W = \quad \text{ft}$
4-4. Calculate the length of the sand filter, $L = WL_R$	$L = \quad \text{ft}$
4-5. Calculate rate of filtration, $r_{wq} = K_i$; where $i = \frac{h + l}{l}$	$r_{wq} = \quad \text{ft/d}$
Step 5: Calculate filter longitudinal underdrain collection pipe	
5-1. Calculated filtered flow rate, $Q_f = r_{wq} A_{sf} / 86400$	$Q_f = \quad \text{cfs}$

5-2. Enter minimum slope for energy gradient, S_e	$S_e =$
5-3. Enter Hazen-Williams coefficient for plastic, C	$C =$
5-4. Enter pipe diameter (6" min.), D	$D =$ in
5-5. Calculate pipe hydraulic radius, $R_h = D/48$	$R_h =$ ft
5-6. Calculate velocity at the outlet of the pipe, $V_p = 1.318CR_h^{0.63}S_e^{0.54}$	$V_p =$ ft/s
5-7. Calculate pipe capacity, $Q_{cap} = 0.25\pi(D/12)^2V_p$	$Q_{cap} =$ cfs
Step 7: Provide conveyance capacity for filter clogging	
7-1. The sand filters should be placed off-line, but an emergency overflow must still be provided in the event the filter becomes clogged.	

Design Example

Step 1: Determine water quality design volume

For this design example, a 10-acre site with soil type 4 and 60% total impervious area is considered.

Step 1: Determine water quality design volume	
1-1. Enter Project area (acres), $A_{project}$	$A_{project} = 10$ acres
1-2. Enter the maximum allowable percent of the Project area that may be effective impervious area (refer to permit), ranges from 5-30%, $\%_{allowable}$	$\%_{allowable} = 5$
1-3. Determine the maximum allowed effective impervious area (ac), $EIA_{allowable} = (A_{project}) * (\%_{allowable})$	$EIA_{allowable} = 0.5$ acres
1-4. Enter Project impervious fraction, Imp (e.g. 60% = 0.60)	$Imp = 0.6$
1-5. Determine the Project Total Impervious area (acres), $TIA = A_{project} * Imp$	$TIA = 6$ acres
1-6. Determine the total area from which runoff must be retained (acres), $A_{retain} = TIA - EIA_{allowable}$	$A_{retain} = 5.5$ acres
1-7. Determine pervious runoff coefficient using Table E-1 , C_p	$C_p = 0.05$
1-8. Calculate runoff coefficient, $C = 0.95 * imp + C_p (1 - imp)$	$C = 0.59$
1-9. Enter design rainfall depth of the storm (in), P_i (see Table D-3)	$P_i = 0.75$ in
1-10. Calculate rainfall depth (ft), $P = P_i / 12$	$P = 0.06$ ft
1-11. Calculate water quality design volume (ft ³), $SQDV = 43560 * C * P * A_{retain}$	$SQDV = 0.20$ ac-ft

Step 1a: Determine maximum storage depth of water

Determine the maximum storage depth of water above the sand filter.

Step 1a: Determine maximum storage depth of water	
1a-1. Determine the maximum storage depth (max 6 ft) of water above the sand filter, d (ft)	$d = 6 \text{ ft}$

Step 2: Calculate Sand Filter Area

A sand filter is designed with two components: (1) temporary storage reservoir to store runoff, and (2) a sand filter bed through which the stored runoff must percolate getting treatment.

The simple sizing method does not route flows through the filter. The size of the filter is determined based on the simple assumption that inflow is immediately discharged through the filter. The adjustment factor, R , is applied to compensate for the greater filter size resulting from this method.

Step 2: Calculate sand filter area	
2-1. Enter water quality design volume, $SQDV$	$SQDV = 0.20 \text{ ac-ft}$
2-2. Enter routing adjustment factor (use $R = 0.7$), R	$R = 0.7$
2-3. Enter thickness of sand filter (min. 2 ft, 3 ft preferred), L	$L = 2 \text{ ft}$
2-4. Enter design hydraulic conductivity (use 2 ft/day), K	$K = 2 \text{ ft/day}$
2-5. Enter drawdown time (use 1 day), t	$t = 2 \text{ day}$
2-6. Calculate average depth of water above the filter, $h = d/2$	$h = 3 \text{ ft}$
2-7. Calculate sand filter area, $A_{sf} = (SQDV * RL) / (Kt (h + L))$	$A_{sf} = 0.014 \text{ acre}$

Step 3: Determine Filter Dimensions

Step 3: Determine filter dimensions	
3-1. Sand filter area in ft^2 , $A_{sf(\text{feet})} = A_{sf(\text{acre})} * 43,560$	$A_{sf} = 610 \text{ ft}^2$
3-2. Enter geometric configuration, LR:W ratio (2:1 min.), L_R	$L_R = 2$
3-3. Calculate the width of the sand filter, W	$W = 18 \text{ ft}$

Step 3: Determine filter dimensions	
3-4. Calculate the length of the sand filter, L	$L = 36$ ft
3-5. Calculate rate of filtration, $r_{wq} = Ki$, where $i = \frac{h+l}{l}$	$r_{wq} = 2.3$ ft/d

Step 4: Calculate Filter Longitudinal Underdrain Collection Pipe

All underdrain pipes must be 6 inches or greater to facilitate cleaning.

Step 5: Calculate filter longitudinal underdrain collection pipe	
5-1. Calculated filtered flow rate, $Q_f = r_{wq}A_{sf}/86400$	$Q_f = 0.01$ cfs
5-2. Enter minimum slope for energy gradient, S_e	$S_e = 0.005$
5-3. Enter Hazen-Williams coefficient for plastic, C	$C = 140$
5-4. Enter pipe diameter (6" min), D	$D = 6$ in
5-5. Calculate pipe hydraulic radius, $R_h = D/48$	$R_h = 0.13$
5-6. Calculate velocity at the outlet of the pipe, $V_p = 1.318CR_h^{0.63}S_e^{0.54}$	$V_p = 2.9$ ft/s
5-7. Calculate pipe capacity, $Q_{cap} = 0.25\pi(D/12)^2V_p$	$Q_{cap} = 0.57$ cfs

Step 5: Provide Conveyance Capacity for Filter Clogging

The sand filters should be placed off-line, but an emergency overflow must still be provided in the event the filter becomes clogged.

APPENDIX F : FLOW SPLITTER DESIGN SPECIFICATIONS

F.1 Flow Splitter Introduction

Flow splitters must be provided for off-line facilities to divert the water quality design flow to the BMP and bypass higher flows. In most cases, it is a designer's choice whether storm water treatment BMPs described in this manual are designed as on-line or off-line; exceptions are vegetated strip filters, permeable pavement, and building BMPs which are designed on-line.

A crucial factor in designing flow splitters is to ensure that low flows are delivered to the treatment facility up to the water quality design flow rate. Above this rate, additional flows remain in the storm drain or are diverted to a bypass drain with minimal increase in head at the flow splitter structure to avoid surcharging the water quality facility under high flow conditions.

Flow splitters are typically manholes or vaults with baffles. In place of baffles, the splitter mechanism may be a half tee section with a solid top and an orifice in the bottom of the tee section. A full tee option may also be used (see "Design Criteria" below). Two possible design options for flow splitters are shown in the figures in this Appendix. Other equivalent designs that achieve the result of splitting low flows, up to the WQ design flow, into the WQ treatment facility and divert higher flows around the facility are also acceptable.

Flow splitters may be modeled using standard level pool routing techniques, as described in the Handbook of Applied Hydrology (Ven te Chow; 1964) and elsewhere. The stage/discharge relationship of the outflow pipes shall be determined using backwater analysis techniques. Weirs shall be analyzed as sharp-crested weirs.

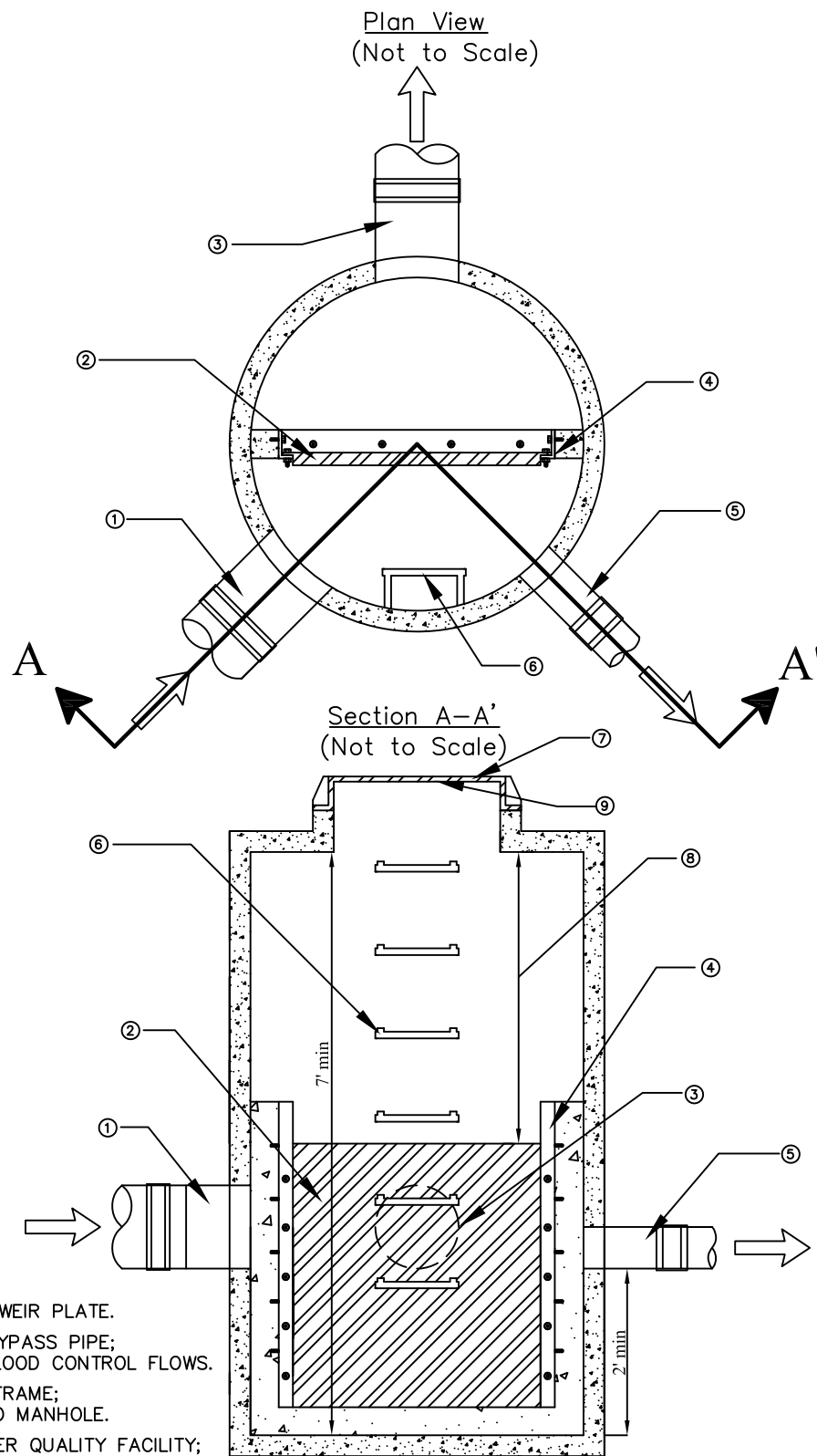
Design Criteria

- 1) A flow splitter shall be designed to deliver the required water quality design flow rate to the storm water treatment facility.
- 17) The top of the weir shall be located at the water surface for the design flow. Remaining flows enter the bypass line.
- 18) The maximum head shall be minimized for flow in excess of the water quality design flow. Specifically, flow to the treatment facility at the flood control design storm water surface shall not increase the design water quality design flow by more than 10%.
- 19) Example designs are shown in the figures in this Appendix. Equivalent designs are also acceptable.
- 20) Special applications, such as roads, may require the use of a modified flow splitter. The baffle wall may be fitted with a notch and adjustable weir plate to proportion runoff volumes other than high flows.

- 21) For ponding facilities, backwater effects must be included in designing the height of the standpipe in the manhole.
- 22) Ladder or step and handhold access shall be provided. If the weir wall is higher than 36 inches, two ladders, on the either side of the wall, are required.

F.2 Material Requirements

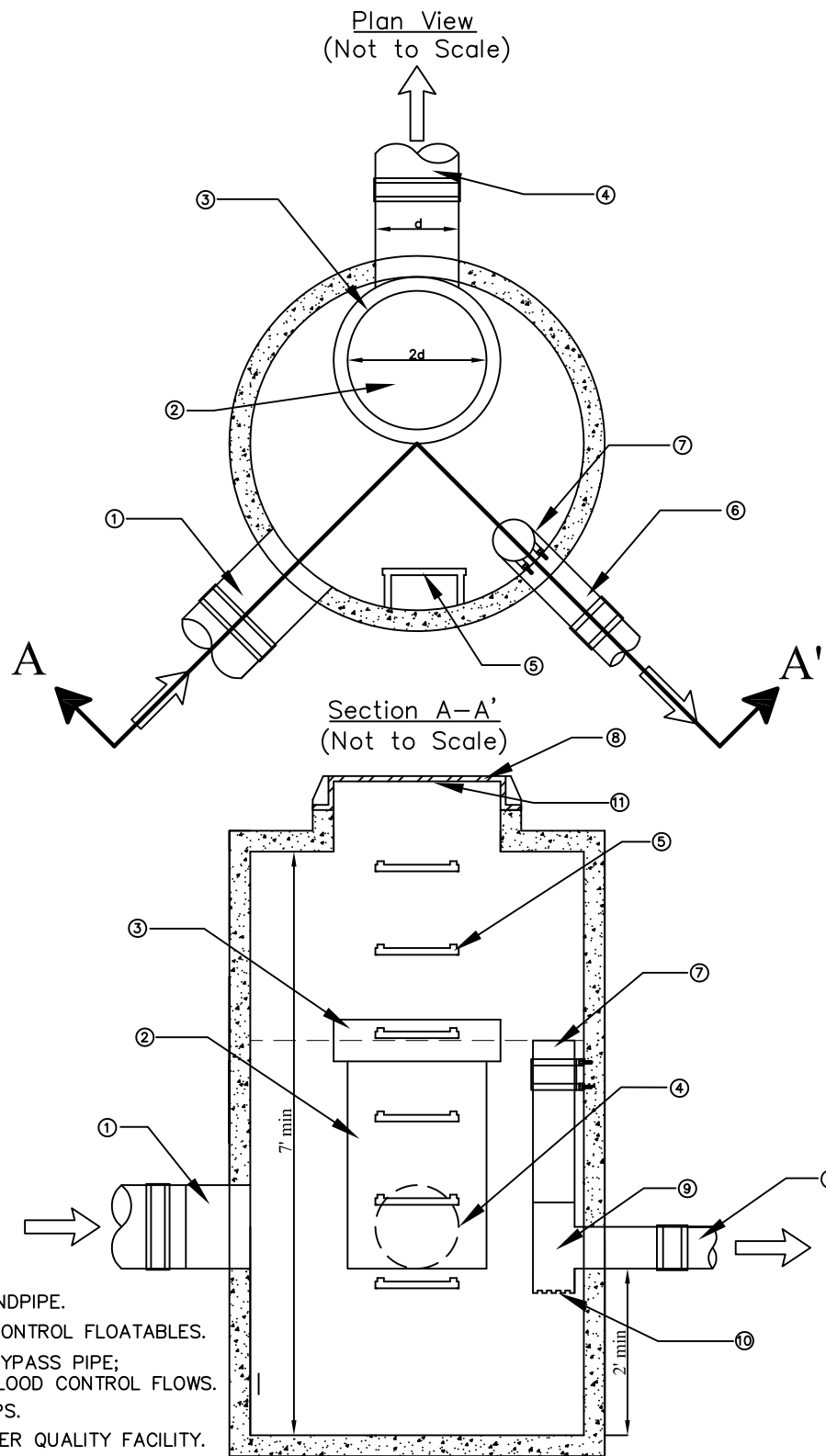
- 1) The splitter baffle shall be installed in a standard manhole or vault. The baffle wall shall be made of material resistant to corrosion (minimum 4-inch thick reinforced concrete, Type 302 or Type 316 stainless steel plate, or equivalent).
- 23) The minimum clearance between the top of the baffle wall and the bottom of the manhole or vault cover shall be 4 feet; otherwise, dual access points shall be provided.
- 24) All metal parts shall be corrosion resistant. Examples of preferred materials include aluminum, stainless steel, and plastic. Zinc and galvanized materials are not permitted because of aquatic toxicity. Painting metal parts shall not be allowed because of poor longevity.



NOTES:


- ① INLET PIPE.
- ② ADJUSTABLE WEIR PLATE.
- ③ HIGH FLOW BYPASS PIPE; SIZED FOR FLOOD CONTROL FLOWS.
- ④ WEIR PLATE FRAME; ANCHORED TO MANHOLE.
- ⑤ PIPE TO WATER QUALITY FACILITY; SIZED FOR WATER QUALITY FLOWS.
- ⑥ ACCESS STEPS.
- ⑦ 24" ROUND FRAME AND SOLID LID.
- ⑧ 4' MIN DISTANCE OR PROVIDE SEPARATE ACCESS ON BOTH SIDES OF WEIR.
- ⑨ AFFIX PERMANENT IDENTIFICATION TAG.

<p>Figure F-1: Flow Splitter Option A</p>



NOTES:

- ① INLET PIPE.
- ② BYPASS STANDPIPE.
- ③ BAFFLE TO CONTROL FLOATABLES.
- ④ HIGH FLOW BYPASS PIPE; SIZED FOR FLOOD CONTROL FLOWS.
- ⑤ ACCESS STEPS.
- ⑥ PIPE TO WATER QUALITY FACILITY.
- ⑦ RISER PIPE; TOP OF PIPE AT DESIGN ELEVATION FOR WATER QUALITY FLOWS.
- ⑧ 24" ROUND FRAME AND SOLID LID.
- ⑨ REMOVABLE "TEE" SECTION FOR CLEANOUT.
- ⑩ RISER PIPE ORIFICE SIZED FOR WATER QUALITY FLOWS.
- ⑪ AFFIX PERMANENT IDENTIFICATION TAG.


<p>Figure F-2: Flow Splitter Option B</p>

APPENDIX G: DESIGN CRITERIA CHECKLISTS FOR STORMWATER RUNOFF BMPS

BIO-1 Bioretention Checklist

- Has the bioretention facility been sized to treat the water quality design volume, SQDV (see worksheet)?
- Does the bioretention have a maximum ponding depth of 18 in. (6 in. without fencing)?
- Is the planting soil depth at least 2 feet?
- Has an underdrain been provided if native soil permeability is less than 0.5 in/hr and infiltration is not possible/allowed?
- Has a gravel drainage layer been provided if native soil permeability is greater than 0.5 in/hr and infiltration is possible/allowed?
- Does the bioretention drain the area below the planting soil in less than 48 hours?
- Is the gravel drainage layer sized to adequately meet the maximum drawdown time of 72 hours?
- Has the bioretention facility been properly sized as recommended in the manual?
- Does the flow entrance meet specifications (dispersed, low velocity flow; dispersed flow across pavement; flow spreading trench; cuts or wheel slots for parking lots)?
- Does the pipe flow entrance include erosion protection material to dissipate flow energy?
- Is the flow path unblocked by trees and shrubs?
- Is the underdrain at least 6 inches in diameter?
- Is the underdrain pipe made of accepted material (slotted PVC pipe conforming to ASTM C 3034 or equivalent HDPE pipe conforming to AASHTO 252M)?
- Does the slotted pipe have correct sizing and spacing of slots?
- Is the underdrain sloped at 0.5% or more?
- Are rigid observation pipes connected to underdrain every 250 to 300 feet of installed pipe?
- Do the observation pipe wells/clean outs extend 6 inches above top elevation of bioretention facility mulch and are they capped as required?

- Does the gravel underdrain bedding consist of the correct aggregate?
- If geotextile fabric is placed between the planting media and gravel layer, does it meet the specifications outlined in the manual?
- Does the gravel underdrain bedding extend at least 6 inches below the underdrain pipe (if needed) and does it provide 1 foot depth around top and sides of pipe?
- Does the underdrain drain freely to the accepted discharge point?
- Is an overflow device consisting of vertical PVC pipe included in design?
- Has the overflow device been installed at the 18-inch ponding depth?
- Is the overflow riser at least 6 inches in diameter?
- Has the inlet to the riser been positioned at least 6 inches above the planting media and capped with a spider cap?
- If bioretention is close to roads or infrastructure, have infiltration pathways been restricted with geomembrane (at least 30 mm) or clay liners?
- Is planting soil composed of correct aggregate (60-70% sand; 15-25% compost; 10-20% topsoil) and free of stones, stumps and roots?
- Does compost have acceptable characteristics (i.e. salt content, pH, etc- see section 4)?
- Does topsoil have acceptable characteristics (see section 4)?
- Is constructed bioretention facility covered with well-aged mulch, free of seeds, weeds, soil and roots, and at least 2-3 inches thick?
- Is planting soil design height marked with a stake and notched to show bioretention surface level and ponding level (this can also be shown with a collar on the vertical riser)?
- Has the bioretention soil mix been tested to meet the criteria listed (see #8 of “planting soil” in bioretention section)?
- Has a landscape architect been contacted to certify that all plants conform to appropriate standards?
- Is all bioretention vegetation tolerant of summer drought, ponding fluctuations, and saturated soil conditions for 48 to 72 hours?
- Have an adequate number of different plant species been incorporated into the bioretention (It is recommended that 3 tree, 3 shrub, and 3 herbaceous

groundcover species be included)?

- Have native plants been used to the maximum extent practicable?

BIO- 2 Planter Box Checklist

- Is the planter box tributary area less than 15,000 ft²?
- Is the groundwater level at least 2 feet below the bottom of the planter box?
- Is there adequate relief between land surface and stormwater conveyance system to permit vertical percolation?
- Is the planter box located in an area with adequate sunlight to support selected vegetation?
- Is the planter box sized to treat the water quality design volume, V_{wq} (see worksheet)?
- Does the planter box have a maximum ponding depth of 12 inches?
- Is the planting soil depth at least 2 feet (3 feet preferred)?
- Does the planter box drain the area below the planting soil in less than 48 hours?
- Has the distance between the downspouts and the overflow outlet been maximized?
- Has the planter box been sized the same as a Bioretention facility with planter box parameters (see Bioretention section, Appendix D)?
- Has the planter box been constructed with an appropriate non-leaching permanent material?
- Has the planter box structure been adequately sealed to ensure that water exits only via the underdrain?
- Has an underdrain been provided?
- If the entrance to the planter box is piped, has erosion protection been included in the design (erosion protection includes rock, splash blocks, etc.)?
- Is the entrance flow path unimpeded by woody plants (trees, shrubs)?
- Is the underdrain at least 6 inches in diameter?
- Is the underdrain pipe made of accepted material (slotted PVC pipe conforming to ASTM C 3034 or equivalent HDPE pipe conforming to AASHTO 252M)?
- Does the slotted pipe have correct sizing and spacing of slots?

APPENDIX G: DESIGN CRITERIA CHECKLISTS

- Is the underdrain sloped at 0.5% or more?
- Are rigid observation pipes connected to underdrain every 250 to 300 feet of installed pipe?
- Do the observation pipe wells/clean outs extend 6 inches above top elevation of the planter box mulch and are they capped as required?
- Does the gravel underdrain bedding consist of the correct aggregate?
- Does the gravel underdrain bedding extend at least 6 inches below the underdrain and does it provide 1 foot depth around top and sides of pipe?
- If geotextile fabric is used in the underdrain design, does it meet minimum materials requirements?
- Is the underdrain elevated from the bottom of the planter box by 6 inches?
- Does the underdrain drain freely to the intended discharge point?
- Is an overflow device consisting of vertical PVC pipe included in design?
- Is the overflow riser at least 6 inches in diameter?
- Is the inlet to the riser 6 inches above planting soil and capped with a spider cap?
- Has a waterproof barrier consisting of a 30 mil geomembrane or equivalent been provided to protect foundations from moisture?
- Is planting soil composed of correct aggregate (60-70% sand; 15-25% compost; 10-20% topsoil) and gradation, and free of stones, stumps and roots?
- Does compost have acceptable characteristics (see planting/storage media)?
- Does topsoil have acceptable characteristics (see planting/storage media)?
- Is planter box covered with well-aged mulch, free of seeds, weeds, grass clippings, bark, soil and roots, and at least 2-3 inches thick?
- Is planting soil design height marked with a stake and notched to show planter box soil level and ponding level (this can also be shown with a collar on the vertical riser)?
- Has the planter box soil mix been tested to meet the criteria listed (see planting/storage media)?
- Do all soil minerals meet requirements?

- Is all planter box vegetation tolerant of summer drought, ponding fluctuations, and saturated soil conditions for 48 to 72 hours?
- Have an adequate number of different plant species been incorporated into the planter box design (It is recommended that 3 tree, 3 shrub, and 3 herbaceous groundcover species be included)?
- Have native plants been used to the maximum extent practicable?
- Are all shade tree trunks free of branches below 5 feet for 1.5 to 2.5 inch diameter branches and below 6 feet for 3 inch or greater diameter branches?
- Have only slow-release fertilizers been included in the design?
- Have arrangements been made to replace planter box mulch layer annually?
- Has the planter box material been chosen to correspond aesthetically with the surroundings?
- Have low-maintenance plants been selected for design?
- Has an effort been made to ensure that no treated wood or galvanized metal is used anywhere within the planter box design?

BIO-3 Proprietary Biotreatment Device Checklist

- Has the proprietary biotreatment device been selected from the list provided in the manual or from another Ventura County- approved list?
- Has the vendor been contacted for the latest design guidance on cartridge selection?
- Has the proprietary biotreatment device been installed as directed by the vendor?
- Have appropriate maintenance and operation arrangements been made to ensure upkeep of the device?
- Has the biotreatment device been sized to capture and treat the water quality design flow?

BIO-4 Vegetated Swale Checklist

- Does the climate provide adequate conditions for maintaining a vegetative cover? Has adequate vegetation been chosen given the climate?
- Is the grade in the area shallow so as to not allow ponding?
- Is the swale compatible with existing flood control functions?
- Has the swale been designed with a depth of one foot or less?
- Have the side slopes been constructed to a H:V ratio or 2:1 (or if the swale is a mowed turf swale, 3:1)?
- Is the overall depth from the top of the side walls to the bottom of the swale at least 12 inches?
- Is the swale bottom width at least 2 feet?
- Is the swale bottom width no greater than 10 feet, or 16 feet with a dividing berm?
- If the swale is required to convey flood flows in addition to the water quality design flow, has the swale been designed for the flood control design storm and does it include 2 feet of freeboard?
- Have gradual meandering bends been incorporated into the design?
- Is the longitudinal slope (in direction of flow) between 1% and 6%?
- Has an underdrain been provided if soils are poorly drained and longitudinal slope is less than 1.5%? Has a soils report been provided if this is the case?
- If the longitudinal slope is greater than 6%, have appropriate check dams with vertical drops of 12 inches or less been provided in the design to reduce the slope?
- Is the horizontal slope at the bottom of the swale flat to discourage channeling?
- Has the swale been designed so that the water depth does not exceed 4 inches or 2/3 the height of vegetation (2 inches in frequently mowed turf swales)?
- Does the swale length provide a minimum hydraulic residence time of 10 minutes?
- If soil and slope conditions require it, has an acceptable low flow drain been

installed?

- Has the swale been designed to convey the SUSMP designed flow (see section D.1 and Appendix D)?
- Has the swale been sized as recommended in Chapter 4 (also see worksheet, Appendix D)?
- Has the swale been designed as a flow-through channel or has a high-flow bypass been incorporated into the design for flows higher than the water quality design flow?
- Has inflow been directed towards the upstream end of the swale or, at a minimum, evenly over the length of the swale?
- If the swale is online, has it been designed to convey flows up to the post-development 100 year 24 hour storm, with freeboard, and velocities below 3 ft/s?
- If the swale is off-line, has it been designed to convey the water quality design flow rate using a flow splitter with velocities below 1 ft/s?
- If check dams are incorporated in the design, have flow spreaders been added at the toe of each vertical drop?
- If curb cuts are used, has pavement been placed 1 – 2 inches above the elevation of the vegetated area?
- Is the swale inflow designed to function long term with minimal maintenance?
- Has flow spreading at the inlet of the swale been achieved by a leveled anchored flow spreader or similar method?
- Does the flow spreader project a minimum of 2 inches above the ground surface with appropriately spaced notches and extend horizontally beyond facility to prevent erosion
- If an underdrain is required, does it meet appropriate criteria (PVC or equivalent, correct slot spacing and sizing, 6 inches minimum in diameter, sloped at 0.5%)?
- Is there gravel bedding at least 6 inches below and 1 foot to the top and sides of the underdrain?
- If a geotextile is included in the design, does it meet requirements?
- Does gravel drainage layer meet recommended criteria?

- Does swale divider, if included, meet criteria (minimum height of 1 inch above flow, slopes no steeper than 2H:1V, stable foundation)?
- Has swale soil been amended with compost if organic content is less than 10%?
- Have appropriate, hardy and native plants been used to the maximum extent practical?
- Is vegetative cover at least 4 inches in height (ideally 6 inches)?
- Has the swale been located away from trees that may drop leaves or provide insufficient sunlight?

BIO-5 Vegetated Filter Strip Checklist

- Is the slope of the filter strip designed to avoid both erosive flows and ponding?
- Has the strip been designed to evenly distribute flow across width and promote sheet flow?
- Does the width of the filter strip extend across the full width of the tributary area?
- Is the upstream boundary of the filter located contiguous to developed area?
- If filter strip is used for water quality purposes, is the length between 15 and 150 feet (25 feet preferred)? If the strip is used for pretreatment, is it at least 4 feet in length?
- Is the slope of the strip parallel to the direction of flow between 2% and 6%?
- Is the lateral slope (perpendicular to flow) of the strip 4% or less?
- Is grading across strip even?
- Has the top of the strip been installed 2 to 5 inches below any adjacent pavement (a beveled transition is also acceptable)?
- Are the top and toe of the slope as flat as possible (graded flat for engineered filter strips) to encourage sheet flow and prevent erosion?
- Has the design flow been calculated using the SUSMP water quality design flow rate (see worksheet)?
- Has the design flow depth been calculated using a modified Manning's equation (see worksheet)?
- Have the design velocity and length been calculated using the design flow and design flow depth as recommended (see worksheet)?
- Has a flow spreader been implemented to uniformly distribute contributing flow along width of filter strip?
- If a gravel flow spreader is used, is it at least 6 inches deep, 12 inches wide and a minimum of 1 inch below the paved surface?
- Has the gravel flow spreader been leveled even where ground is not level?
- If the gravel flow spreader is placed along a roadway, have LA county design specifications been consulted and implemented?

- If a notched curb spreader and through-curb spreader are used, have they been used in conjunction with a gravel spreader?
- Have curb port/interrupted curb openings been spaced at intervals of at least every 6 feet?
- Do the curb port/interrupted curb openings have a width of at least 11 inches?
- Does 15% or more of the curb length consist of open ports and does each port discharge no more than 10% of the flow?
- Have energy dissipaters (such as a riprap pad) been used if a sudden slope drop occurs?
- Has access been provided at the upper edge of filter strip for mowing equipment and to enable maintenance of spreader?
- Is the design water depth 1 inch or less?
- Does the design velocity not exceed 1 foot per second?
- If the organic content of the filter strip soil does not exceed 10%, has the soil been amended with at least 2 inches of well-rotted acceptable compost at a depth of 6 inches?
- Is filter strip uniformly graded and densely vegetated with erosion-resistant grasses (preferably native or adapted species)?
- Has irrigation been provided to establish grasses?
- Have maintenance arrangements been made to maintain grass at a height of 2 to 4 inches?
- Have trees and shrubs been limited along the filter strip?
- Has an effort been made to ensure that no treated wood or galvanized metal is used anywhere within the design?

BIO-6 Green Roof Checklist

- Is the roof shallow enough to support a green roof (<25% slope)?
- Are the roof supports sufficient to support additional weight of soil, water, vegetation, and a drainage layer(if needed) [a licensed structural engineer should be consulted]?
- Has an appropriate waterproof membrane been placed below the green roof?
- Has an appropriate drainage layer been incorporated in the design (if required)?
- Has an appropriate soil mix been used in the design to allow for drainage, support vegetative growth, and that is not excessively heavy when wet?
- Has vegetation been carefully selected to improve aesthetics, resist erosion, withstand extreme environments, and tolerate drought without the need for fertilizers and pesticides and without a lot of maintenance requirements (see Appendix H for a recommended plant list)?
- Have native plants been chosen to the maximum extent practical?
- If trees or shrubs are incorporated, has an adequate soil depth been provided and is the additional soil depth supported by the roof structure?
- Has irrigation been provided to establish vegetation?
- Does vegetation cover 90% of the total area?
- Is the green roof located in an area without excessive shade to avoid poor vegetative growth?
- Is there an appropriate drain pipe or gutter to convey any runoff from roof to a stormwater BMP or stormwater conveyance system?

FILT-1 Sand Filter Checklist

- Has sand filter been located away from trees and areas that could contribute eroded sediment?
- If there is a chance for sediment to be present in flow to be treated, has pretreatment been provided?
- Does site have adequate relief to permit vertical percolation through sand filter and into conveyance system?
- Has pretreatment (vegetated swale or filter strip, hydrodynamic separator) been adequately provided to reduce the sediment load entering the filter?
- Has the sand filter been sized to capture the SUSMP defined water quality design volume?
- Has the sand filter been designed with a 1.5:1 length to width ratio or greater?
- Is the filter bed depth at least 2 feet (3 feet preferred)?
- Is the depth of water storage over the filter bed 6 feet or less?
- Is the overflow structure designed to pass the water quality design storm?
- Has the sizing of the filter been determined using the adapted Darcy's Law equation recommended in the sizing methodology section in Chapter 4 (also see worksheet, Appendix D)?
- Does the sand meet the recommended specifications (0.2-0.35 mm diameter, $C_u < 3$, ASTM C 33 size gradation, etc.)?
- Has an underdrain been employed in the design? [Examples: central underdrain w/lateral pipes, longitudinal pipes, single pipe for small filters]
- Is the underdrain placed in an 8 inch minimum gravel backfill or drain rock bed?
- Are all underdrain pipes and connectors 6 inches or greater with clean-out risers of equal diameter?
- Have clean-out risers been placed at the terminal ends of all pipes and extend to the surface of the filter?
- Has a valve box been provided for access to the clean-outs and is it water tight?
- Are underdrain pipes laid with perforations downward, and are perforations

at least 1/2 inch in diameter?

- Are all lateral collection pipes within 9 feet or less of each other (perpendicular distance)?
- Have all pipes been placed with a minimum slope of 0.5%?
- Is the invert of the underdrain outlet above the seasonal high groundwater level?
- Is gravel backfill present around the underdrain pipe at least 6 inches below and to the sides of the pipe and 8 inches above the pipe?
- Does the bottom gravel have a diameter of at least 2 times the size of the perforated openings to the drainage system and meet other specifications (specific gravity of 2.5 or more, rounded, free of debris)?
- Has an appropriate geotextile layer (see underdrain section) or 2-inch transition layer been placed between the sand layer and the drain rock/gravel backfill layer?
- Has a flow spreader been installed at the inlet along one side of the filter (long side of the filter if L: W is 2:1 or greater; 20% of perimeter for curved or irregular shape)?
- Has erosion protection been provided along the first foot of the sand bed adjacent to the flow spreader (i.e. geotextile weighted with sand bags; quarry spalls)?
- Has no topsoil, clay, or sod (except sod grown in sand) has been added to the sand filter bed?
- Has vegetation been selected properly (i.e. must withstand drought, heavy saturation, etc.)?
- Are no permanent structures built on top of the sand filter bed?
- No large shrubs or trees should be planted in sand filter bed or within 15 feet of inlet or outlet pipes
- Have native plants been used to the maximum extent practicable?
- Has an emergency overflow structure been provided?
- Are interior side slopes above water quality design depth no steeper than 3:1 H:V?
- Are exterior side slopes no steeper than 2:1 H:V?

- If pond walls are vertical retaining walls, do they meet recommended specifications (see side slopes section)?
- Do embankments meet appropriate criteria [top width or 20 feet, constructed on native consolidated soil, in accordance with LACDPW standard specifications, proper excavation, constructed of appropriate compacted soil]?
- Are maintenance access roads/ramps to filter provided?
- Are access roads and ramps constructed according to LACDPW standards (3 inches concrete over 4 inches crushed aggregate, maximum grade of 12%, centerline radius of 40 feet or more, etc)?
- Do access roads meet appropriate length to width requirements and terminate into appropriately sized turn-arounds?
- If street crossings are nearby, have adequate gates and driveways been provided?
- Have trees and shrubs been planted further than 10 feet away from inlet and outlet pipes (50 feet for 'water-seeking' plants such as willows and poplars)?
- Have prohibited non-native plants been removed from the site?
- Has an effort been made to ensure that no treated wood or galvanized metal is used anywhere within the planter box design?

FILT-2 Cartridge Media Filter

- Has the cartridge media filter been selected from the manual provided list of vendors or from a similar list distributed by LA county?
- Has the vendor been contacted for the latest design guidance on cartridge selection?
- Has the cartridge media filter been provided with a system to completely drain the system and prevent vector annoyances?
- Has the cartridge media filter been sized to capture and treat the water quality design flow?
- Have site considerations been taken into account when sizing the cartridge media filter and selecting features (often vendor websites offer assistance with this)?

INF-1 Infiltration Trench Checklist

- Has the infiltration trench been located away from steep slopes (>25%)?
- Is the infiltration trench set back from structures and leach fields?
- Is there at least 10 feet or vertical separation between the bottom of the infiltration trench and the shallow groundwater table?
- Is the depth to bedrock adequate to provide proper infiltration?
- Has the site been checked to ensure that no preexisting contamination is present?
- Does the site have low sediment loading rates to prevent infiltration trench clogging?
- Has a soil assessment report been completed, which determines the suitability of the site for an infiltration trench, recommends a design infiltration rate, identifies the high depth to groundwater table surface elevation, and examines how the stormwater runoff will move in the soil?
- Has a geotechnical investigation and report been provided if needed?
- Has the infiltration trench been located at a site that does not receive run off from sites that store or use chemicals or hazardous waste outside?
- Has the infiltration trench been set back from existing septic system drain fields and drinking water wells?
- Has pretreatment been provided with a vegetated swale, filter strip, sand filter or proprietary device?
- Is the trench at least 2 feet wide and 3 to 5 feet deep?
- Is the longitudinal slope of the trench 3% or less?
- Is the top layer of the media filter gravel/choking stone/geotextile fabric if flow is sheet flow and 12 inches of surface soil if flow enters through an underground pipe?
- Is middle layer of media filter 3-5 feet of washed 1.5 to 3 in. gravel with void space of 30 to 40%?
- Is bottom layer of media filter 6" of clean, washed sand?
- Have one or more observation wells been installed?
- Do observation wells consist of recommended slotted 4-6 inch diameter

PVC well screen capped with lockable, above-ground lid?

- Has the infiltration trench been sized to capture and infiltrate the SUSMP defined water quality design volume?
- Has the infiltration trench been designed to infiltrate all runoff within 72 hours?
- Has the maximum depth of runoff, ponding depth/trench depth and infiltrating surface area been calculated using recommended design equations (see sizing methodology section/worksheet)?
- Is the bottom of the infiltration bed native soil, over-excavated to at least one foot in depth and replaced uniformly (with 2-4 inches of coarse sand amendments) without compaction?
- Has all vertical piping been classified correctly (see drainage section in manual)?
- Has an observation well been incorporated into the design to ensure that the 72 hour maximum drawdown time is met?
- Has an overflow route been provided to safely convey flows that overtop the facility or in the case that the facility becomes clogged?
- Has the overflow channel been designed to safely convey flows from peak design storm to a downstream conveyance system or acceptable discharge point?
- Has the infiltration trench been kept free of vegetation, and is all existing vegetation surrounding the trench been planted away from trench to avoid drip lines overhanging the facility?
- Is there safe maintenance access provided to the site for both wet and dry conditions?
- Has an access road along the length of the trench been provided if there is no existing road or parking lot that can be used for maintenance access?
- Has access to “operate a backhoe at ‘arms length’” been provided?
- Was the entire area draining to the facility stabilized before construction began?
- Have you ensured that the infiltration trench is not hydraulically connected to the storm water conveyance system?
- If heavy construction material was used to compact subgrade (not recommended), has the infiltrative capacity of the soil been restored via

tilling or aerating prior to placing the infiltration bed?



Were the exposed subgrade soils inspected by a civil engineer prior to construction to confirm suitable soil conditions for the infiltration facility?

INF-2 Drywell Checklist

- Has the drywell been located away from steep slopes (>25%)?
- Is the drywell set back from structures and leach fields?
- Is there at least 10 feet or vertical separation between the bottom of the drywell and the shallow groundwater table?
- Is the depth to bedrock adequate to provide proper infiltration?
- Has the site been checked to ensure that no preexisting contamination is present?
- Does the site have low sediment loading rates to prevent drywell from clogging?
- Has pretreatment been provided for all non-rooftop runoff flowing to the drywell?
- Has a geotechnical investigation and report been provided to ensure site meets specifications for an infiltration facility (including soil infiltration rate, groundwater separation, and no steep slopes)?
- Has a soil assessment report been completed, which determines the suitability of the site for an drywell, recommends a design infiltration rate, identifies the high depth to groundwater table surface elevation, and examines how the stormwater runoff will move in the soil?
- Has the drywell been located at a site that does not receive run off from sites that store or use chemicals or hazardous waste outside?
- Has the drywell been set back from existing septic system drain fields and drinking water wells?
- Has pretreatment been provided to prevent sediment and other large particulates?
- Is the surface area of the drywell large enough to infiltrate the storage volume in 72 hours based on maximum allowable depth?
- Is the top layer of the media filter gravel/choking stone/geotextile fabric if flow is sheet flow and 12 inches of surface soil if flow enters through an underground pipe (pipe should be fitted with a screen)?
- Is middle layer of media filter 3-5 feet of washed 1.5 to 3 in. gravel with void space of 30 to 40%?
- Is bottom layer of media filter 6" of clean, washed sand?

- Have one or more observation wells been installed?
- Do observation wells consist of recommended slotted 4-6 inch diameter PVC well screen capped with lockable, above-ground lid?
- Has the drywell been sized to capture and infiltrate the SUSMP defined water quality design volume?
- Has the drywell been designed to infiltrate all runoff within 72 hours?
- Has a long term percolation rate of 10% of the measured percolation rate been used in design (due to occlusion and particulate accumulation)?
- Has the maximum depth of runoff, ponding depth/trench depth and infiltrating surface area been calculated using recommended design equations (see sizing methodology section/worksheet)?
- Is the bottom of the infiltration bed native soil, over-excavated to at least one foot in depth and replaced uniformly (with 2-4 inches of coarse sand amendments) without compaction?
- Has all vertical piping been classified correctly (see drainage section in manual)?
- Has an observation well been incorporated to ensure that the 72 hour maximum drawdown time is met?
- Has an overflow route been provided to safely convey flows that overtop the facility or in the case that the facility becomes clogged?
- Has the overflow channel been designed to safely convey flows from peak design storm to a downstream conveyance system or acceptable discharge point?
- Has the drywell been kept free of vegetation, and is all existing vegetation surrounding the trench been planted away from trench to avoid drip lines overhanging the facility?
- Is there safe maintenance access provided to the site for both wet and dry conditions?
- Has an access road along the length of the trench been provided if there is no existing road or parking lot that can be used for maintenance access and has access to operate at 'arms length' been provided?
- Was the entire area draining to the facility stabilized before construction began?

- Have you ensured that the infiltration trench is not hydraulically connected to the storm water system?
- If heavy construction material was used to compact subgrade (not recommended), has the infiltrative capacity of the soil been restored via tilling or aerating prior to placing the infiltration bed?
- Were the exposed subgrade soils inspected by a civil engineer prior to construction to confirm suitable soil conditions for the infiltration facility?

INF-3 Proprietary Infiltration BMPs Checklist

- Has the infiltration facility been located away from steep slopes (>25%)?
- Is the infiltration facility set back from structures and leach fields?
- Is there at least 10 feet or vertical separation between the bottom of the infiltration facility and the shallow groundwater table?
- Is the depth to bedrock adequate to provide proper infiltration?
- Has the site been checked to ensure that no preexisting contamination is present?
- Does the site have low sediment loading rates to prevent infiltration facility clogging?
- Has pretreatment been provided to prevent premature failure (If infiltration facility fails, complete construction is required)?
- Has infiltration facility been designed to receive runoff only from sections of the site that have been stabilized?
- If infiltration facility fails, complete construction is required
- Has a geotechnical investigation and report been provided to ensure site meets specifications for an infiltration facility (including soil infiltration rate, groundwater separation, and no steep slopes)?
- Has a soil assessment report been completed, which determines the suitability of the site for an infiltration trench, recommends a design infiltration rate, identifies the high depth to groundwater table surface elevation, and examines how the stormwater runoff will move in the soil?
- Has the infiltration trench been located at a site that does not receive run off from sites that store or use chemicals or hazardous waste outside?
- Has the infiltration BMP been sized to capture and treat the water quality design volume?
- Has a long term percolation rate of 10% of the measured percolation rate been used in design (due to occlusion and particulate accumulation)?
- Have the recommended sizing guidelines set by the vendor been referenced and used for selection and use of infiltration facility?

INF-4 Permeable Pavement Checklist

- Has the permeable pavement been located away from steep slopes (>25%)?
- Is the permeable pavement set back from structures and leach fields?
- Is there at least 10 feet or vertical separation between the bottom of the permeable pavement and the shallow groundwater table?
- Is the depth to bedrock adequate to provide proper infiltration?
- Has the site been checked to ensure that no preexisting contamination is present?
- Does the site have low sediment loading rates to prevent infiltration trench clogging?
- Has the permeable pavement been designed to receive runoff only from sections of the site that have been stabilized?
- Has a geotechnical investigation and report been provided to ensure site meets specifications for an infiltration facility (including soil infiltration rate, groundwater separation, and no steep slopes)?
- Has a soil assessment report been completed, which determines the suitability of the site for an infiltration trench, recommends a design infiltration rate, identifies the high depth to groundwater table surface elevation, and examines how the stormwater runoff will move in the soil?
- Has the permeable pavement been located at a site that does not receive run off from sites that store or use chemicals or hazardous waste outside?
- Has the run off been assessed for necessity of pretreatment?
- If pretreatment is required, has it been provided to treat run on before it reaches permeable pavement?
- Has the infiltration BMP been sized to capture and treat the water quality design volume?
- Have the infiltration capabilities of the site been assessed (i.e. full, partial, or no infiltration allowed)?
- If no infiltration is allowed, has an underdrain been prohibited?
- If permeable pavement is located on a site with a slope greater than 2%,

has the area been terraced to prevent lateral flow through subsurface?

- Has the permeable pavement been designed to infiltrate flows through four different layers (incl. top wearing layer, stone reservoir, and transition layers) of material (or through a similar system)?
- Has the depth of each layer (and void space), along with the hydrology, hydraulics, and structural requirements of the site been determined and approved by a licensed civil engineer?
- If proprietary permeable pavement is used (i.e. concrete or other pavers), have the design requirements and installation steps been obtained from the vendor and referenced in the selection and construction of the permeable pavement?
- Has the permeable pavement been designed to drain in less than 72 hours and allowed to dry out periodically?
- Has a long term percolation rate of 10% of the measured percolation rate been used in design (due to occlusion and particulate accumulation)?
- Has an overflow mechanism been included in the pavement design?
- If the overflow mechanism employed is perimeter control, have controls such as a perimeter vegetated swale, perimeter Bioretention, storm drain inlets, or other acceptable control been implemented?
- If the overflow mechanism employed are overflow pipes, have the pipes been connected to the underdrain, are they located away from vehicular traffic, and is the top of the pipe fitted with a screen?
- Has the pavement been laid close to level with bottom of base layers level to ensure uniform infiltration?
- Are site materials stored away from permeable pavement?
- Has landscaping and stabilization of adjacent areas been completed before installation of pavement?

GS-1 Hydrodynamic Separation Device Checklist

- Has the hydrodynamic device been selected from the supplied list of vendors or from a similar list provided by LA County Department of Public Works?
- Has the vendor been contacted for the latest model and design guidance prior to selection of device?
- Has the device been sized to capture and treat the water quality design flow rate?
- Has the vendor been contacted for sizing and installation guidance?
- Has periodic maintenance been scheduled and budgeted for?

GS-2 Catch Basin Insert Checklist

- Has the catch basin insert been selected from the supplied list of vendors or from a similar list provided by LA County Department of Public Works?
- Has the vendor been contacted for the latest model and design guidance prior to selection of device?
- Has the insert been sized to capture and treat the water quality design flow rate?
- Has the vendor been contacted for sizing and installation guidance?
- Has periodic maintenance been scheduled and budgeted for?

APPENDIX H: STORMWATER CONTROL MEASURE ACCESS AND MAINTENANCE AGREEMENTS

(Long Form)

Recorded at the request of:

City of _____

After recording, return to:

City of _____

City Clerk

Stormwater Treatment Device Access and Maintenance Agreement

OWNER:

PROPERTY ADDRESS: _____

APN:

THIS AGREEMENT is made and entered into in _____,
California, this ___ day of _____, by and between _____
_____, hereinafter referred to as "Owner" and the CITY OF _____
_____, a municipal corporation, located in the County of Ventura,
State of California hereinafter referred to as "CITY";

WHEREAS, the Owner owns real property ("Property") in the City of _____,
County of Ventura, State of California, more specifically described in Exhibit "A" and
depicted in Exhibit "B", each of which exhibits is attached hereto and incorporated
herein by this reference;

WHEREAS, at the time of initial approval of development project known as _____
_____ within the Property described
herein, the City required the project to employ on-site control measures to minimize
pollutants in urban runoff;

WHEREAS, the Owner has chosen to install a _____
_____, hereinafter
referred to as "Device", as the on-site control measure to minimize pollutants in
urban runoff;

WHEREAS, said Device has been installed in accordance with plans and
specifications accepted by the City;

WHEREAS, said Device, with installation on private property and draining only private property, is a private facility with all maintenance or replacement, therefore, the sole responsibility of the Owner in accordance with the terms of this Agreement;

WHEREAS, the Owner is aware that periodic and continuous maintenance, including, but not necessarily limited to, filter material replacement and sediment removal, is required to assure peak performance of Device and that, furthermore, such maintenance activity will require compliance with all Local, State, or Federal laws and regulations, including those pertaining to confined space and waste disposal methods, in effect at the time such maintenance occurs;

NOW THEREFORE, it is mutually stipulated and agreed as follows:

- 1) Owner hereby provides the City of City's designee complete access, of any duration, to the Device and its immediate vicinity at any time, upon reasonable notice, or in the event of emergency, as determined by City's Director of Public Works no advance notice, for the purpose of inspection, sampling, testing of the Device, and in case of emergency, to undertake all necessary repairs or other preventative measures at owner's expense as provided in paragraph 3 below. City shall make every effort at all times to minimize or avoid interference with Owner's use of the Property.
- 2) Owner shall use its best efforts diligently to maintain the Device in a manner assuring peak performance at all times. All reasonable precautions shall be exercised by Owner and Owner's representative or contractor in the removal and extraction of material(s) from the Device and the ultimate disposal of the material(s) in a manner consistent with all relevant laws and regulations in effect at the time. As may be requested from time to time by the City, the Owner shall provide the City with documentation identifying the material(s) removed, the quantity, and disposal destination.
- 3) In the event Owner, or its successors or assigns, fails to accomplish the necessary maintenance contemplated by this Agreement, within five (5) days of being given written notice by the City, the City is hereby authorized to cause any maintenance necessary to be done and charge the entire cost and expense to the Owner or Owner's successors or assigns, including administrative costs, attorneys fees and interest thereon at the maximum rate authorized by the Civil Code from the date of the notice of expense until paid in full.
- 4) The City may require the owner to post security in form and for a time period satisfactory to the city of guarantee the performance of the obligations state herein. Should the Owner fail to perform the obligations under the Agreement, the City may, in the case of a cash bond, act for the Owner using the proceeds from it, or in the case of a surety bond, require the sureties to perform the obligations of the Agreement. As an additional remedy, the Director may withdraw any previous stormwater related approval with respect to the

APPENDIX H: STORMWATER CONTROL MEASURES ACCESS AND MAINTENANCE AGREEMENTS

property on which a Device has been installed until such time as Owner repays to City it's reasonable costs incurred in accordance with paragraph 3 above.

- 5) This agreement shall be recorded in the Office of the Recorder of Ventura County, California, at the expense of the Owner and shall constitute notice to all successors and assigns of the title to said Property of the obligation herein set forth, and also a lien in such amount as will fully reimburse the City, including interest as herein above set forth, subject to foreclosure in event of default in payment.
- 6) In event of legal action occasioned by any default or action of the Owner, or its successors or assigns, then the Owner and its successors or assigns agree(s) to pay all costs incurred by the City in enforcing the terms of this Agreement, including reasonable attorney's fees and costs, and that the same shall become a part of the lien against said Property.
- 7) It is the intent of the parties hereto that burdens and benefits herein undertaken shall constitute covenants that run with said Property and constitute a lien there against.
- 8) The obligations herein undertaken shall be binding upon the heirs, successors, executors, administrators and assigns of the parties hereto. The term "Owner" shall include not only the present Owner, but also its heirs, successors, executors, administrators, and assigns. Owner shall notify any successor to title of all or part of the Property about the existence of this Agreement. Owner shall provide such notice prior to such successor obtaining an interest in all or part of the Property. Owner shall provide a copy of such notice to the City at the same time such notice is provided to the successor.
- 9) Time is of the essence in the performance of this Agreement.
- 10) Any notice to a party required or called for in this Agreement shall be served in person, or by deposit in the U.S. Mail, first class postage prepaid, to the address set forth below. Notice(s) shall be deemed effective upon receipt, or seventy-two (72) hours after deposit in the U.S. Mail, whichever is earlier. A party may change a notice address only by providing written notice thereof to the other party.

IF TO CITY:

IF TO OWNER:

IN WITNESS THEREOF, the parties hereto have affixed their signatures as of the date first written above.

APPROVED AS TO FORM:

OWNER:

City Attorney

Owner

Name: _____

Title: _____

CITY OF _____ :

OWNER:

Name: _____

Name: _____

Title: _____

Title: _____

ATTEST:

City Clerk

Date

Notaries on Following Page

EXHIBIT A

(Legal Description)

EXHIBIT B

(Map/illustration)

(Short Form)

Recorded at the request of and mail to:

Covenant and Agreement Regarding

Stormwater Treatment Device Maintenance

The undersigned hereby certify that we are the owners of hereinafter legally described real property located in the City of _____, County of Ventura, State of California.

Legal Description: _____

as recorded in Book _____, Page _____, Records of Ventura County,

which property is located and known as **(Address):** _____

And in consideration of the City of _____ allowing _____

on said property, we do hereby covenant and agree to and with said City to maintain according to the Maintenance Plan (Attachment 1), all structural stormwater treatment devices including the following:

This Covenant and Agreement shall run all of the above described land and shall be binding upon ourselves, and future owners, encumbrances, their successors, heirs, or assignees and shall continue in effect until released by the authority of the City upon submittal of request, applicable fees, and evidence that this Covenant and Agreement is no longer required by law.

NOTARIES ON FOLLOWING PAGE

APPENDIX I : STORMWATER CONTROL MEASURE MAINTENANCE PLAN GUIDELINES AND CHECKLISTS

Included in this appendix are a series of checklists that can be used by both inspectors and maintenance personnel to ensure that observed deficiencies in BMPs are maintained appropriately. The BMP Inspection/Maintenance Checklists are presented in the following order:

- 1) [Bioretention/Planter Box](#)
- 25) [Vegetated Swale Filter](#)
- 26) [Vegetated Filter Strip](#)
- 27) [Sand Filter](#)
- 28) [Infiltration BMPs](#)
- 29) [Permeable Pavement](#)
- 30) [Constructed Treatment Wetland](#)
- 31) [Wet Retention Basin](#)
- 32) [Dry Extended Detention Basin](#)
- 33) [Proprietary Devices](#)

I.1 Bioretention/Planter Box Inspection and Maintenance Checklist

Date: _____ Work Order # _____

Type of Inspection: post-storm annual routine post-wet season pre-wet season

Facility: _____ Inspector(s): _____

Defect	Conditions When Maintenance Is Needed	Inspection Result (0, 1, or 2) [†]	Date Maintenance Performed	Comments or Action(s) Taken to Resolve Issue
Appearance	Untidy			
Trash and Debris Accumulation	Trash, plant litter and dead leaves accumulated on surface.			
Vegetation	Unhealthy plants and appearance.			
Irrigation	Functioning incorrectly (if applicable).			
Inlet	Inlet pipe blocked or impeded.			
Splash Blocks	Blocks or pads correctly positioned to prevent erosion.			
Overflow	Overflow pipe blocked or broken.			
Filter media	Infiltration design rate is met (e.g., drains 36-48 hours after moderate - large storm event).			

[†]Maintenance: Enter 0 if satisfactory, 1 if maintenance is needed and include WO#. Enter 2 if maintenance was performed same day.

I.2 Vegetated Swale Filter Inspection and Maintenance Checklist

Date: _____ Work Order # _____

Type of Inspection: post-storm annual routine post-wet season pre-wet season

Facility: _____ Inspector(s): _____

Defect	Conditions When Maintenance Is Needed	Inspection Result (0, 1, or 2)†	Date Maintenance Performed	Comments or Action(s) Taken to Resolve Issue
Appearance	Untidy			
Trash and Debris Accumulation	Trash and debris accumulated in the swale.			
Vegetation	When the grass becomes excessively tall (greater than 10-inches); when nuisance weeds and other vegetation start to take over.			
Excessive Shading	Vegetation growth is poor because sunlight does not reach swale. Evaluate vegetation suitability.			
Poor Vegetation Coverage	When vegetation is sparse or bare or eroded patches occur in more than 10% of the swale bottom. Evaluate vegetation suitability.			
Sediment Accumulation	Sediment depth exceeds 2 inches or covers more than 10% of design area.			
Standing Water	When water stands in the swale between storms and does not drain freely.			
Flow spreader or Check Dams	Flow spreader or check dams uneven or clogged so that flows are not uniformly distributed through entire swale width.			

APPENDIX I: STORMWATER BMP MAINTENANCE PLAN GUIDANCE AND CHECKLISTS

Defect	Conditions When Maintenance Is Needed	Inspection Result (0, 1, or 2)†	Date Maintenance Performed	Comments or Action(s) Taken to Resolve Issue
Constant Baseflow	When small quantities of water continually flow through the swale, even when it has been dry for weeks and an eroded, muddy channel has formed in the swale bottom.			
Inlet/Outlet	Inlet/outlet areas clogged with sediment and/or debris.			
Erosion/ Scouring	Eroded or scoured swale bottom due to flow channelization, or higher flows. Eroded or rilled side slopes.			
	Eroded or undercut inlet/outlet structures			

†Maintenance: Enter 0 if satisfactory, 1 if maintenance is needed and include WO#. Enter 2 if maintenance was performed same day.

I.3 Vegetated Filter Strip Inspection and Maintenance Checklist

Date: _____ Work Order # _____

Type of Inspection: post-storm annual routine post-wet season pre-wet season

Facility: _____ Inspector(s): _____

Defect	Conditions When Maintenance Is Needed	Inspection Result (0, 1 or 2) [†]	Date Maintenance Performed	Comments or Action(s) Taken to Resolve Issue
Appearance	Untidy			
Trash and Debris Accumulation	Trash and debris accumulated on the filter strip.			
Vegetation	When the grass becomes excessively tall (greater than 10-inches); when nuisance weeds and other vegetation starts to take over.			
Excessive Shading	Grass growth is poor because sunlight does not reach swale. Evaluate grass species suitability.			
Poor Vegetation Coverage	When grass is sparse or bare or eroded patches occur in more than 10% of the swale bottom. Evaluate grass species suitability.			
Erosion/Scouring	Eroded or scoured areas due to flow channelization, or higher flows.			
Sediment Accumulation on Grass	Sediment depth exceeds 2 inches.			
Flow spreader	Flow spreader uneven or clogged so that flows are not uniformly distributed through entire filter width.			

[†]Maintenance: Enter 0 if satisfactory, 1 if maintenance is needed and include WO#. Enter 2 if maintenance was performed same day.

I.4 Sand Filter Inspection and Maintenance Checklist

Date: _____ Work Order # _____

Type of Inspection: post-storm annual routine post-wet season pre-wet season

Facility: _____ Inspector(s): _____

Defect	Conditions When Maintenance Is Needed	Inspection Result (0,1, or 2) [†]	Date Maintenance Performed	Comments or Action(s) taken to resolve issue
Trash & Debris	Any trash and debris which exceed 5 cubic feet per 1,000 square feet of filter bed area (one standard garbage can). In general, there shall be no visual evidence of dumping. If less than threshold all trash and debris will be removed as part of next scheduled maintenance.			
Inlet erosion	Visible evident of erosion occurring near flow spreader outlets.			
Slow drain time	Standing water long after storm has passed (after 24 to 48 hours) and/or flow through the overflow pipes occurs frequently.			
Concentrated Flow	Flow spreader uneven or clogged so that flows are not uniformly distributed across the sand filter.			
Appearance of poisonous, noxious or nuisance vegetation	Excessive grass and weed growth. Noxious weeds, woody vegetation establishing, Turf growing over rock filter			
Standing Water	Standing water long after storm has passed (after 24 to 48 hours), and/or flow through the overflow pipes occurs frequently.			

APPENDIX I: STORMWATER BMP MAINTENANCE PLAN GUIDANCE AND CHECKLISTS

Defect	Conditions When Maintenance Is Needed	Inspection Result (0,1, or 2) [†]	Date Maintenance Performed	Comments or Action(s) taken to resolve issue
Tear in Filter Fabric	When there is a visible tear or rip in the filter fabric allowing water to bypass the fabric.			
Pipe Settlement	If piping has visibly settled more than 1 inch.			
Filter Media	Drawdown of water through the media takes longer than 1 hour and/or overflow occurs frequently.			
Short Circuiting	Flows do not properly enter filter cartridges.			

[†]Maintenance: Enter 0 if satisfactory, 1 if maintenance is needed and include WO#. Enter 2 if maintenance was performed same day.

I.5 Infiltration BMP Inspection and Maintenance Checklist

Date: _____ Work Order # _____

Type of Inspection: post-storm annual routine post-wet season pre-wet season

Facility: _____ Inspector(s): _____

Defect	Conditions When Maintenance Is Needed	Inspection Result (0,1, or 2) †	Date Maintenance Performed	Comments or Action(s) Taken to Resolve Issue
Appearance, vegetative health	Mowing and trimming vegetation is needed to prevent establishment of woody vegetation, and for aesthetic and vector reasons.			
Vegetation	Poisonous or nuisance vegetation or noxious weeds.			
	Excessive loss of turf or ground cover (if applicable).			
Trash & Debris	Trash and debris > 5 cf/1,000 sf (one standard size garbage can).			
Contaminants and Pollution	Any evidence of oil, gasoline, contaminants or other pollutants.			
Erosion	Undercut or eroded areas at inlet or outlet structures.			
Sediment and Debris	Accumulation of sediment, debris, and oil/grease on surface, inflow, outlet or overflow structures.			
Sediment and Debris	Accumulation of sediment and debris, in sediment forebay and pretreatment devices.			
Water drainage rate	Standing water, or by visual inspection of wells (if available), indicates design drain times are not being achieved (i.e., within 72 hours).			

APPENDIX I: STORMWATER BMP MAINTENANCE PLAN GUIDANCE AND CHECKLISTS

Defect	Conditions When Maintenance Is Needed	Inspection Result (0,1, or 2) †	Date Maintenance Performed	Comments or Action(s) Taken to Resolve Issue
Media clogging surface layer	Lift surface layer (and filter fabric if installed) and check for media clogging with sediment (function may be able to be restored by replacing surface aggregate/filter cloth).			
Media clogging	Lift surface layer (and filter fabric if installed) and check for media clogging with sediment (partial or complete clogging which may require full replacement).			

†Maintenance: Enter 0 if satisfactory, 1 if maintenance is needed and include WO#. Enter 2 if maintenance was performed same day.

I.6 Permeable Pavement Inspection and Maintenance Checklist

Date: _____ Work Order # _____

Type of Inspection: post-storm annual routine post-wet season pre-wet season

Facility: _____ Inspector(s): _____

Defect	Conditions When Maintenance Is Needed	Inspection Result (0,1, or 2) [†]	Date Maintenance Performed	Comments or Action(s) taken to resolve issue
Sediment Accumulation	Sediment is visible			
Missing gravel/sand fill	There are noticeable gaps in between pavers			
Weeds/mosses filling voids	Vegetation is growing in/on permeable pavement			
Trash and Debris Accumulation	Trash and debris accumulated on the permeable pavement.			
Dead or dying vegetation in adjacent landscaping	Vegetation is dead or dying leaving bare soil prone to erosion			
Surface clog	Clogging is evidenced by ponding on the surface			
Overflow clog	Excessive build up of water accompanied by observation of low flow in observation well (connected to underdrain system) If a surface overflow system is used, observation of an obvious clog			
Visual contaminants and pollution	Any visual evidence of oil, gasoline, contaminants or other pollutants.			
Erosion	Tributary area Exhibits signs of erosion Noticeably not completely stabilized			

APPENDIX I: STORMWATER BMP MAINTENANCE PLAN GUIDANCE AND CHECKLISTS

Defect	Conditions When Maintenance Is Needed	Inspection Result (0,1, or 2) [†]	Date Maintenance Performed	Comments or Action(s) taken to resolve issue
Deterioration/ Roughening	Integrity of pavement is compromised (i.e., cracks, depressions, crumbling, etc.)			
Subsurface Clog	Clogging is evidenced by ponding on the surface and is not remedied by addressing surface clogging.			
[†] Maintenance: Enter 0 if satisfactory, 1 if maintenance is needed and include WO#. Enter 2 if maintenance was performed same day.				

I.7 Constructed Treatment Wetland Inspection and Maintenance Checklist

Date: _____ Work Order # _____

Type of Inspection: post-storm annual routine post-wet season pre-wet season

Facility: _____ Inspector(s): _____

Defect	Conditions When Maintenance Is Needed	Inspection Result (0,1, or 2) [†]	Date Maintenance Performed	Comments or Action(s) taken to resolve issue
Trash & Debris	Any trash and debris which exceed 5 cubic feet per 1,000 sf of basin area (one standard garbage can). In general, there shall be no visual evidence of dumping. If less than threshold all trash and debris will be removed as part of next scheduled maintenance. If trash and debris is observed blocking or partially blocking an outlet structure or inhibiting flows between cells, it shall be removed quickly			
Sediment Accumulation	Sediment accumulation in basin bottom that exceeds the depth of sediment zone plus 6 inches in the sediment forebay. If sediment is blocking an inlet or outlet, it shall be removed.			
Erosion	Erosion of basin's side slopes and/or scouring of basin bottom.			
Oil Sheen on Water	Prevalent and visible oil sheen.			

APPENDIX I: STORMWATER BMP MAINTENANCE PLAN GUIDANCE AND CHECKLISTS

Defect	Conditions When Maintenance Is Needed	Inspection Result (0,1, or 2) [†]	Date Maintenance Performed	Comments or Action(s) taken to resolve issue
Noxious Pests	Visual observations or receipt of complaints of numbers of pests that would not be naturally occurring and could pose a threat to human or aquatic health.			
Water Level	First cell empty, doesn't hold water.			
Aesthetics	Minor vegetation removal and thinning. Mowing berms and surroundings			
Noxious Weeds	Any evidence of noxious weeds.			
Tree Growth	Tree growth does not allow maintenance access or interferes with maintenance activity (i.e., slope mowing, silt removal, vactoring, or equipment movements). If trees are not interfering, do not remove. Dead, diseased, or dying trees shall be removed.			
Settling of Berm	If settlement is apparent. Settling can be an indication of more severe problems with the berm or outlet works. A geotechnical engineer shall be consulted to determine the source of the settlement if the dike/berm is serving as a dam.			
Piping through Berm	Discernable water flow through basin berm. Ongoing erosion with potential for erosion to continue. A licensed geotechnical engineer shall be called in to inspect and evaluate condition and recommend repair of condition.			

APPENDIX I: STORMWATER BMP MAINTENANCE PLAN GUIDANCE AND CHECKLISTS

Defect	Conditions When Maintenance Is Needed	Inspection Result (0,1, or 2) [†]	Date Maintenance Performed	Comments or Action(s) taken to resolve issue
Tree and Large Shrub Growth on Downstream Slope of Embankments	Tree and large shrub growth on downstream slopes of embankments may prevent inspection and provide habitat for burrowing rodents.			
Erosion on Spillway	Rock is missing and soil is exposed at top of spillway or outside slope.			
Gate/Fence Damage	Damage to gate/fence, including missing locks and hinges			
[†] Maintenance: Enter 0 if satisfactory, 1 if maintenance is needed and include WO#. Enter 2 if maintenance was performed same day.				

I.8 Wet Retention Basin Inspection and Maintenance Checklist

Date: _____ Work Order # _____

Type of Inspection: post-storm annual routine post-wet season pre-wet season

Facility: _____ Inspector(s): _____

Defect	Conditions When Maintenance Is Needed	Inspection Result (0,1, or 2) [†]	Date Maintenance Performed	Comments or Action(s) taken to resolve issue
Trash & Debris	Any trash and debris which exceed 5 cubic feet per 1,000 sf of basin area (one standard garbage can) or if trash and debris is excessively clogging the outlet structure. If less than threshold all trash and debris will be removed as part of next scheduled maintenance.			
Sediment Accumulation	Sediment accumulation in basin bottom that exceeds the depth of the design sediment zone plus 6 inches, usually in the first cell.			
Erosion	Erosion of basin's side slopes and/or scouring of basin bottom.			
Oil Sheen on Water	Prevalent and visible oil sheen.			
Noxious Pests	Visual observations or receipt of complaints of numbers of pests that would not be naturally occurring and could pose a threat to human or aquatic health.			
Water Level	First cell empty, doesn't hold water.			
Algae Mats	Algae mats over more than 20% of the water surface.			
Aesthetics	Minor vegetation removal and thinning. Mowing berms and surroundings			

APPENDIX I: STORMWATER BMP MAINTENANCE PLAN GUIDANCE AND CHECKLISTS

Defect	Conditions When Maintenance Is Needed	Inspection Result (0,1, or 2) [†]	Date Maintenance Performed	Comments or Action(s) taken to resolve issue
Noxious Weeds	Any evidence of noxious weeds.			
Tree Growth	Tree growth does not allow maintenance access or interferes with maintenance activity (i.e., slope mowing, silt removal, vactoring, or equipment movements). If trees are not interfering, do not remove. Dead, diseased, or dying trees shall be removed.			
Settling of Berm	If settlement is apparent. Settling can be an indication of more severe problems with the berm or outlet works. A geotechnical engineer shall be consulted to determine the source of the settlement if the dike/berm is serving as a dam.			
Piping through Berm	Discernable water flow through basin berm. Ongoing erosion with potential for erosion to continue. A licensed geotechnical engineer shall be called in to inspect and evaluate condition and recommend repair of condition.			
Tree and Large Shrub Growth on Downstream Slope of Embankments	Tree and large shrub growth on downstream slopes of embankments may prevent inspection and provide habitat for burrowing rodents.			
Erosion on Spillway	Rock is missing and soil is exposed at top of spillway or outside slope.			
Gate/Fence Damage	Damage to gate/fence, including missing locks and hinges			

[†]Maintenance: Enter 0 if satisfactory, 1 if maintenance is needed and include WO#. Enter 2 if maintenance was performed same day.

I.9 Dry Extended Detention Basin Inspection and Maintenance Checklist

Date: _____ Work Order # _____

Type of Inspection: post-storm annual routine post-wet season pre-wet season

Facility: _____ Inspector(s): _____

Defect	Conditions When Maintenance Is Needed	Inspection Result (0, 1 or 2)†	Date Maintenance Performed	Comments or Action(s) Taken to Resolve Issue
General				
Appearance	Untidy, un-mown (if applicable)			
Vegetation	Access problems or hazards; dead or dying trees			
	Poisonous or nuisance vegetation or noxious weeds			
Insects	Insects such as wasps and hornets interfere with maintenance activities.			
Rodent Holes	Any evidence of rodent holes if facility is acting as a dam or berm, or any evidence of water piping through dam or berm via rodent holes			
Trash and Debris	Trash and debris > 5 cf/1,000 sf (one standard size garbage can).			
Pollutants	Any evidence of oil, gasoline, contaminants or other pollutants			
Inlet/Outlet Pipe	Inlet/Outlet pipe clogged with sediment and/or debris. Basin not draining.			
Erosion	Erosion of the basin's side slopes and/or scouring of the basin bottom that exceeds 2-inches, or where continued erosion is prevalent.			

APPENDIX I: STORMWATER BMP MAINTENANCE PLAN GUIDANCE AND CHECKLISTS

Defect	Conditions When Maintenance Is Needed	Inspection Result (0, 1 or 2)†	Date Maintenance Performed	Comments or Action(s) Taken to Resolve Issue
Piping	Evidence of or visible water flow through basin berm.			
Settlement of Basin Dike/Berm	Any part of these components that has settled 4-inches or lower than the design elevation, or inspector determines dike/berm is unsound.			
Overflow Spillway	Rock is missing and/or soil is exposed at top of spillway or outside slope.			
Sediment Accumulation in Basin Bottom	Sediment accumulations in basin bottom that exceeds the depth of sediment zone plus 6-inches.			
Tree or shrub growth	Trees > 4 ft in height with potential blockage of inlet, outlet or spillway; or potential future bank stability problems			
Debris Barriers (e.g., Trash Racks)				
Trash and Debris	Trash or debris that is plugging more than 20% of the openings in the barrier.			
Damaged/ Missing Bars	Bars are bent out of shape more than 3 inches.			
	Bars are missing or entire barrier missing.			
	Bars are loose and rust is causing 50% deterioration to any part of barrier.			
Inlet/Outlet Pipe	Debris barrier missing or not attached to pipe.			
Fencing				
Missing or broken parts	Any defect in the fence that permits easy entry to a facility.			

APPENDIX I: STORMWATER BMP MAINTENANCE PLAN GUIDANCE AND CHECKLISTS

Defect	Conditions When Maintenance Is Needed	Inspection Result (0, 1 or 2)†	Date Maintenance Performed	Comments or Action(s) Taken to Resolve Issue
Erosion	Erosion more than 4 inches high and 12-18 inches wide, creating an opening under the fence.			
Damaged Parts	Damage to gate/fence, posts out of plumb, or rails bent more than 6 inches.			
Deteriorating Paint or Protective Coating	Part or parts that have a rusting or scaling condition that has affected structural adequacy.			
Gates				
Damaged or missing member	Missing gate or locking devices, broken or missing hinges, out of plum more than 6 inches and more than 1 foot out of design alignment, or missing stretcher bar, stretcher bands, and ties.			

†Maintenance: Enter 0 if satisfactory, 1 if maintenance is needed and include WO#. Enter 2 if maintenance was performed same day.

I.10 Proprietary Device Inspection and Maintenance Checklist

Date: _____ Work Order # _____

Type of Inspection: post-storm annual routine post-wet season pre-wet season

Facility: _____ Inspector(s): _____

Defect	Conditions When Maintenance Is Needed	Inspection Result (0,1, or 2) †	Date Maintenance Performed	Comments or Action(s) taken to resolve issue
Refer to the manufacturer's instructions for maintenance/inspection requirements, below are generic guidelines to supplement manufacturer's recommendations.				
Underground Vault				
Sediment Accumulation on Media	Sediment depth exceeds 0.25-inches.			
Sediment Accumulation in Vault	Sediment depth exceeds 6-inches in first chamber.			
Trash/Debris Accumulation	Trash and debris accumulated on compost filter bed.			
Sediment in Drain Pipes or Cleanouts	When drain pipes, clean-outs, become full with sediment and/or debris.			
Damaged Pipes	Any part of the pipes that are crushed or damaged due to corrosion and/or settlement.			
Access Cover Damaged/Not Working	Cover cannot be opened; one person cannot open the cover using normal lifting pressure, corrosion/deformation of cover.			
Vault Structure Includes Cracks in Wall, Bottom, Damage to	Cracks wider than 1/2-inch or evidence of soil particles entering the structure through the cracks, or maintenance/inspection personnel determine that the vault is not structurally sound.			

APPENDIX I: STORMWATER BMP MAINTENANCE PLAN GUIDANCE AND CHECKLISTS

Defect	Conditions When Maintenance Is Needed	Inspection Result (0,1, or 2) †	Date Maintenance Performed	Comments or Action(s) taken to resolve issue
Frame and/or Top Slab	Cracks wider than 1/2-inch at the joint of any inlet/outlet pipe or evidence of soil particles entering through the cracks.			
Baffles	Baffles corroding, cracking warping, and/or showing signs of failure as determined by maintenance/inspection person.			
Access Ladder Damaged	Ladder is corroded or deteriorated, not functioning properly, not securely attached to structure wall, missing rungs, cracks, or misaligned.			
Below Ground Cartridge Type				
Filter Media	Drawdown of water through the media takes longer than 1 hour and/or overflow occurs frequently.			
Short Circuiting	Flows do not properly enter filter cartridges.			

†Maintenance: Enter 0 if satisfactory, 1 if maintenance is needed and include WO#. Enter 2 if maintenance was performed same day.